

BuzziLand

Oval | Round

INSTALLATION MANUAL

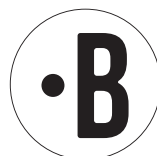
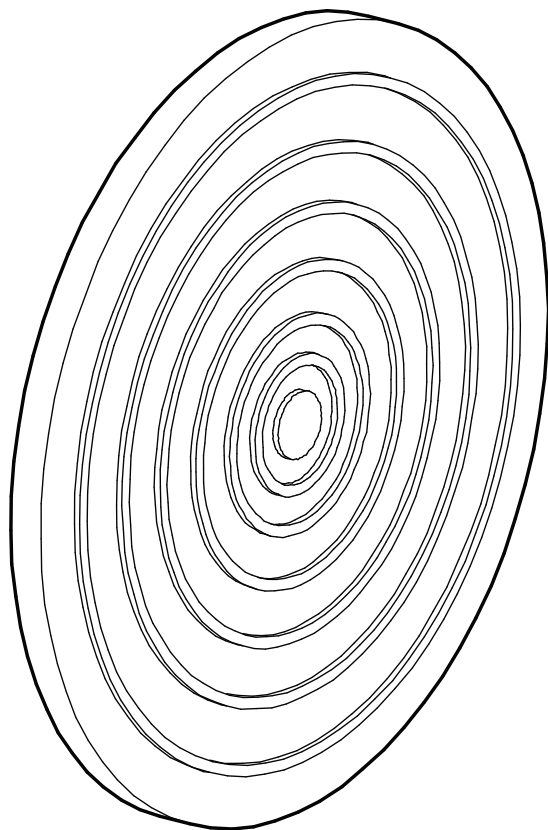

BuzziLand Wall Mounted p.3

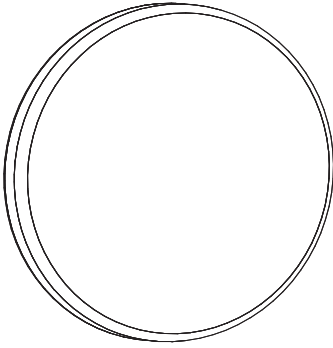

BuzziLand Ceiling Suspended Fixing System Screw p.6

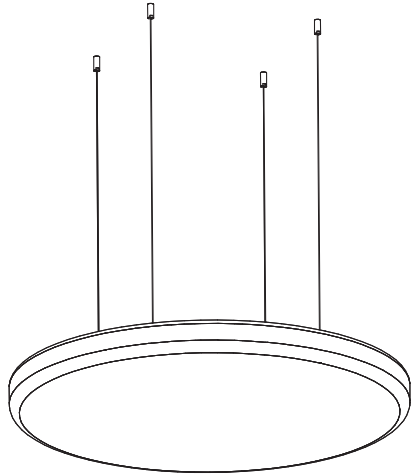

BuzziLand Ceiling Suspended Fixing System Magnet p.14

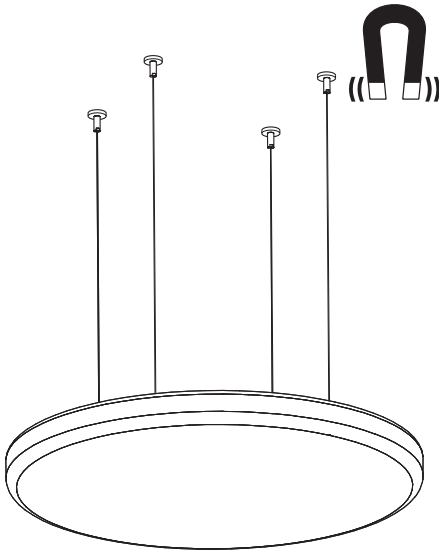

BuzziLand Wall Mounted

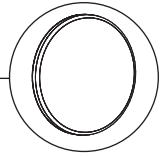

2 PERS. 

Excluded



3 | 6x  3 | 6x 

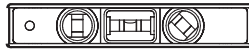
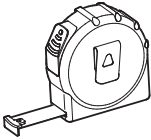
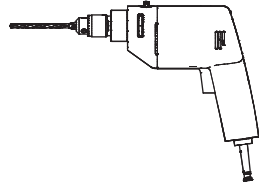

Included

Oval

Round

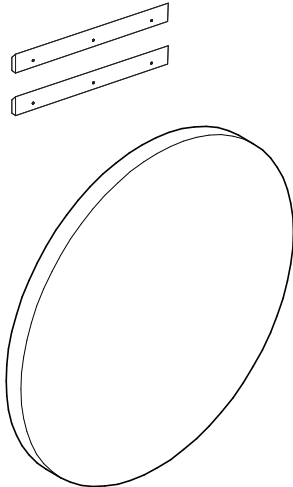
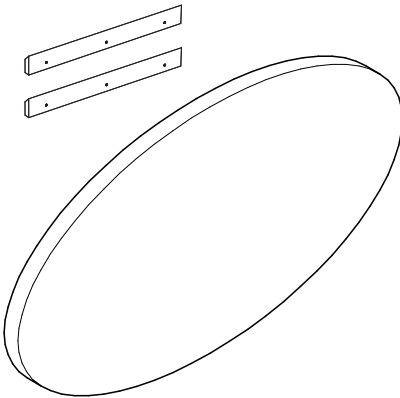

1

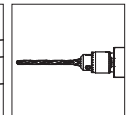
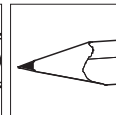
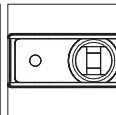
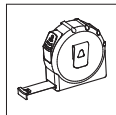
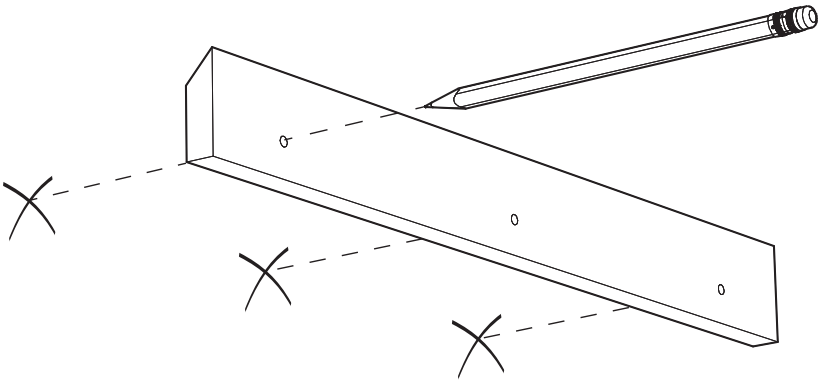
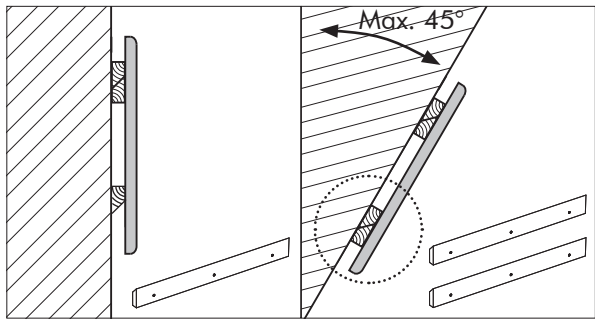

2

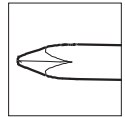
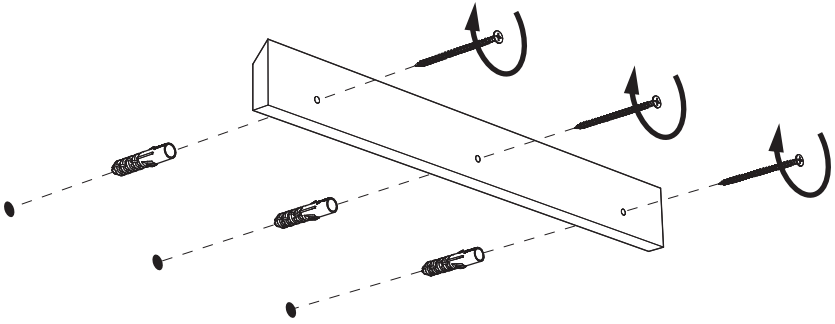

3

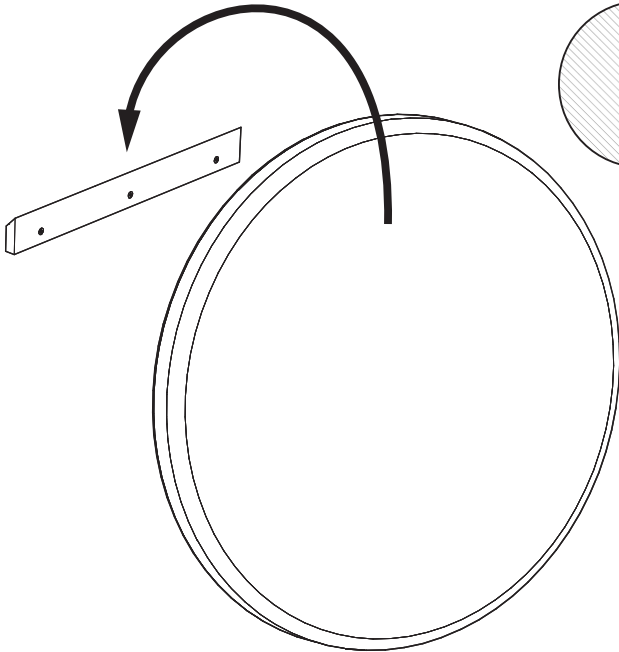

BuzziLand Ceiling Suspended Fixing System Screw

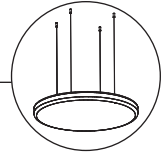

1 PERS. 

Excluded

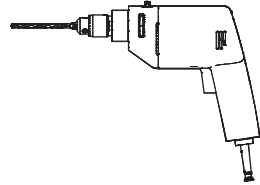

4x 

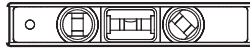
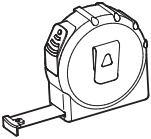

Cable Set (to be ordered separately)

4x

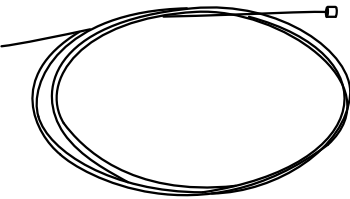

M6

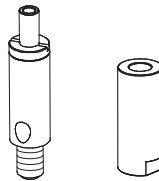
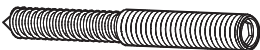

Included

Oval

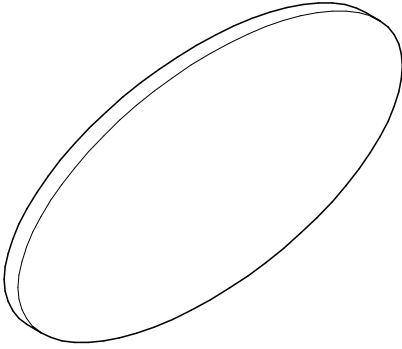

Round

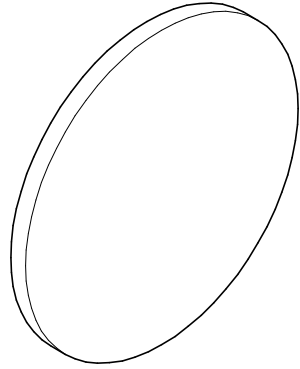

Dimensions Fixing Points

Oval

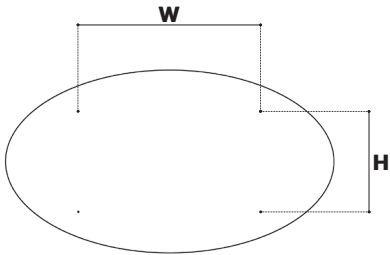

- S:** W 65 cm H 45 cm
W 25.59" H 17.72"
- M:** W 85 cm H 45 cm
W 33.46" H 17.72"
- L:** W 85 cm H 45 cm
W 33.46" H 17.72"
- XL:** W 85 cm H 65 cm
W 33.46" H 25.59"

Round

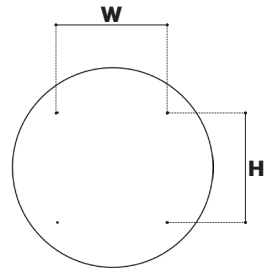

- S:** W 45 cm H 45 cm
W 17.72" H 17.72"
- M:** W 45 cm H 45 cm
W 17.72" H 17.72"
- L:** W 65 cm H 65 cm
W 25.59" H 25.59"

1

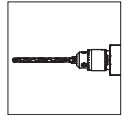
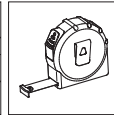
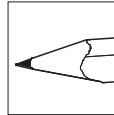
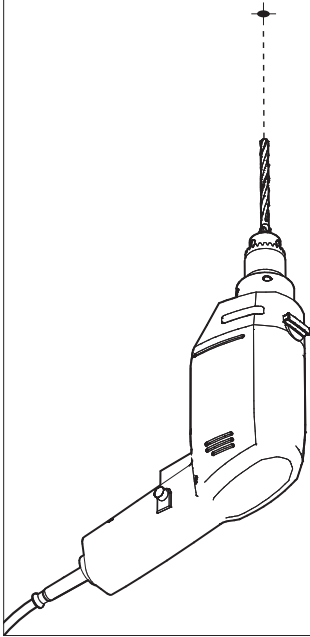

2

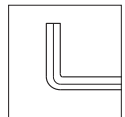
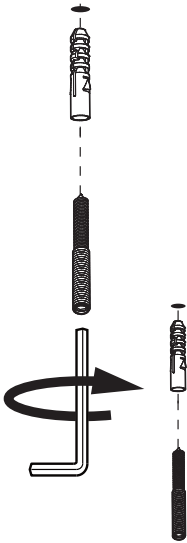

3

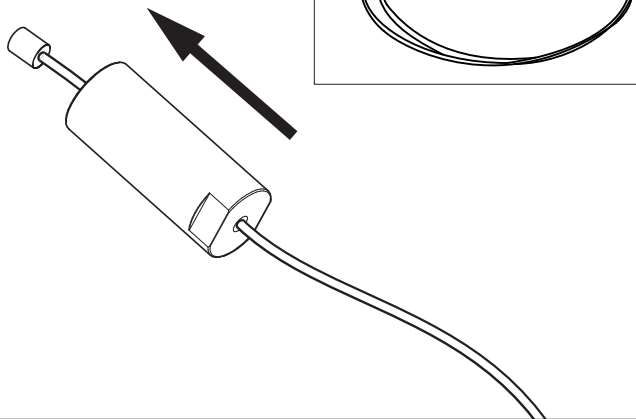

4

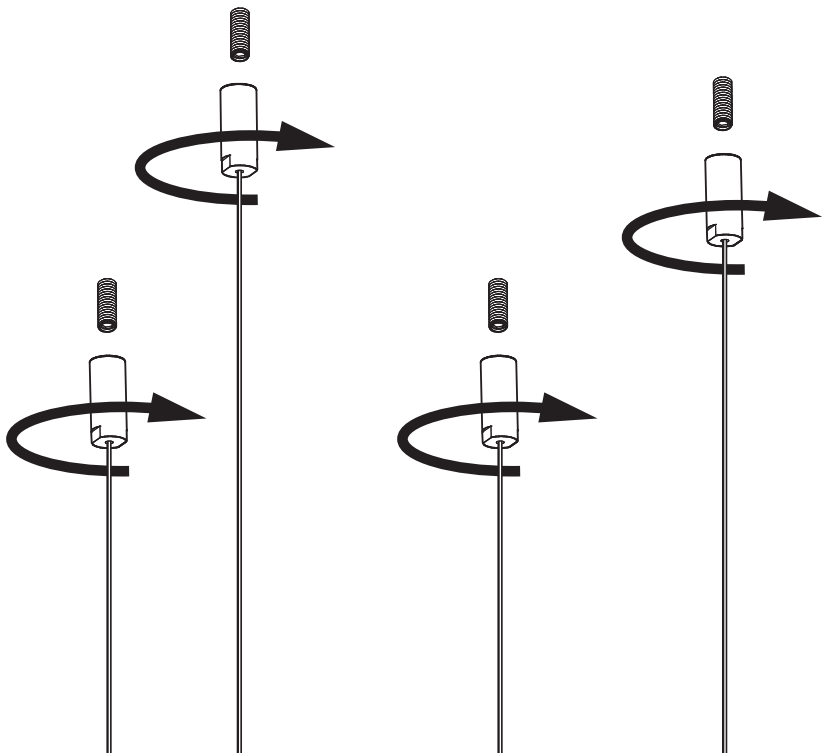

5

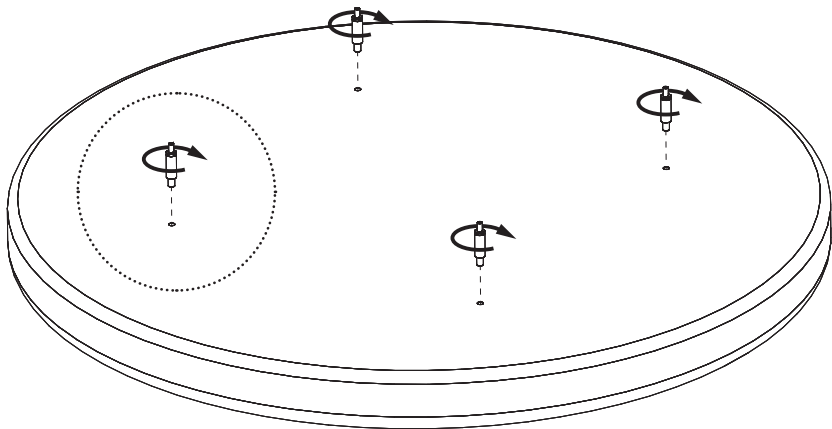
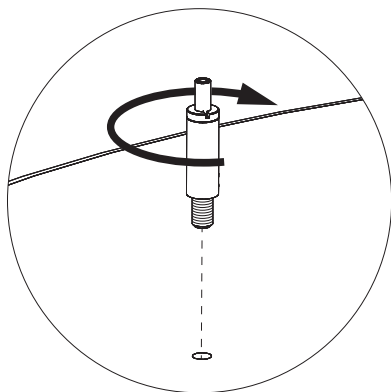

6

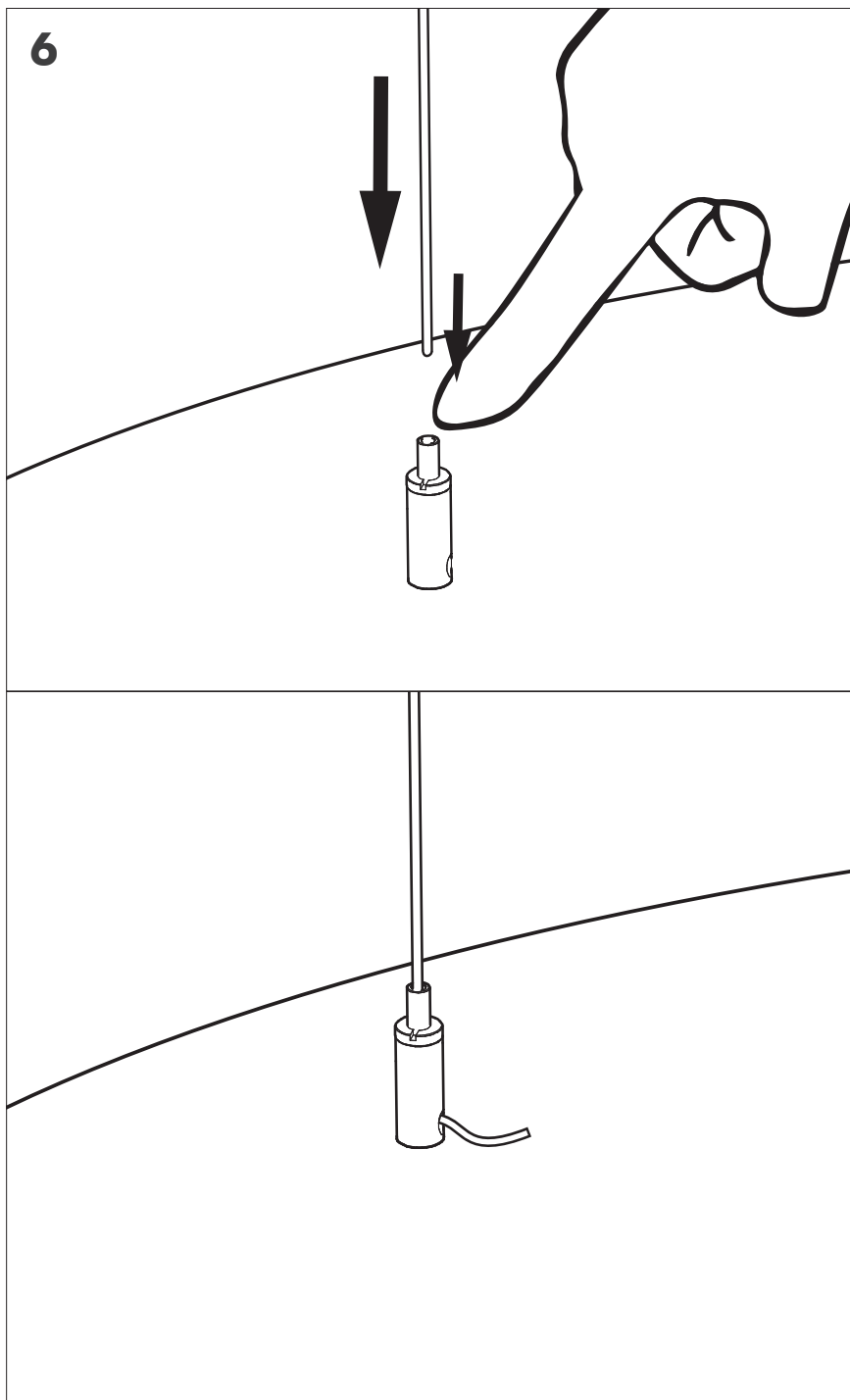

7

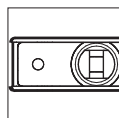
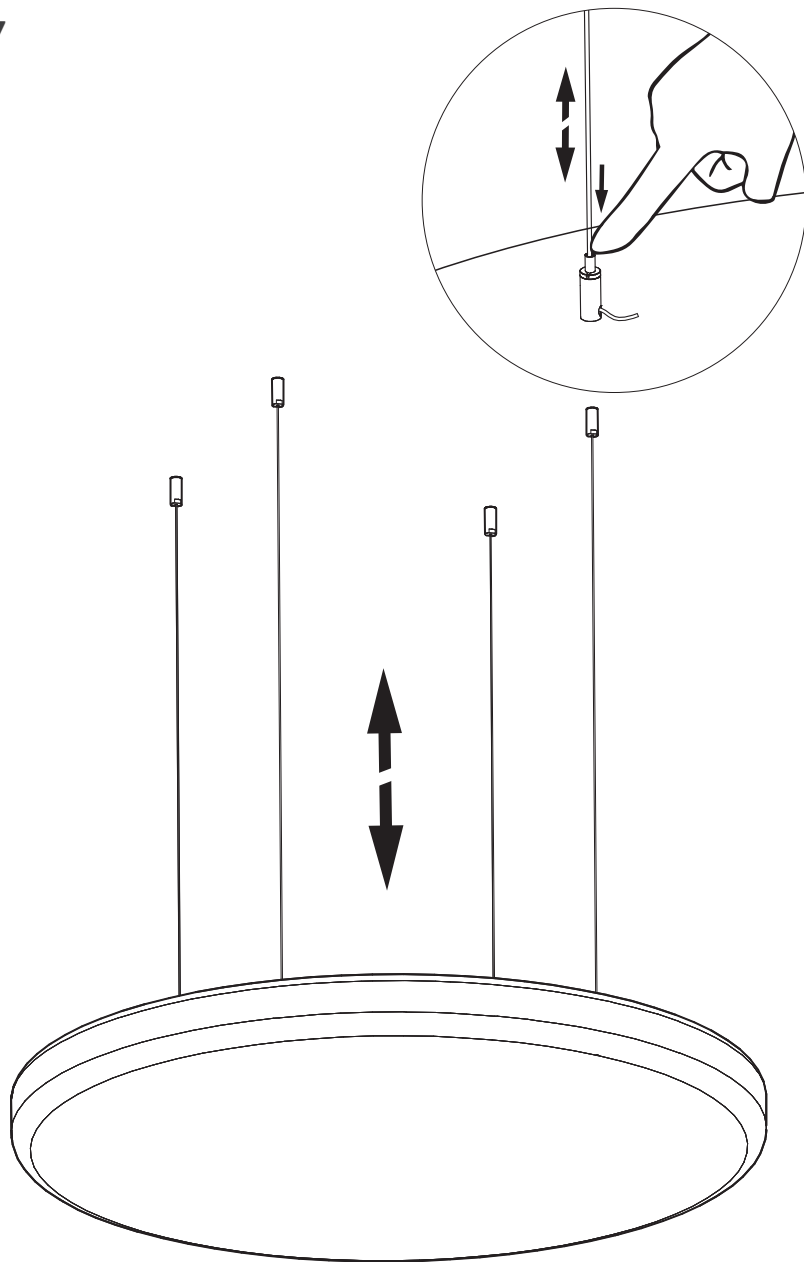

BuzziLand Ceiling Suspended Fixing System Magnet

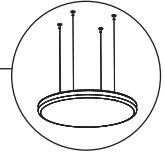

1 PERS. 

Excluded

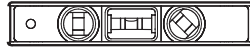
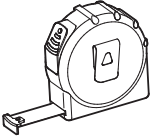

Cable Set Magnet (to be ordered separately)

4x

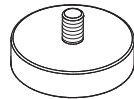
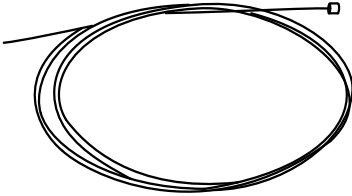

Included

Oval

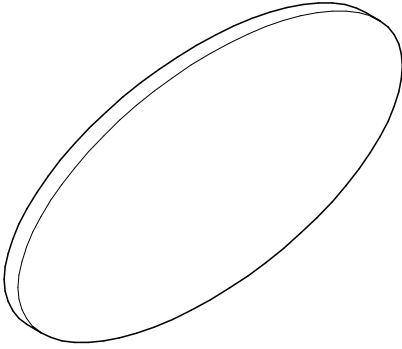

Round

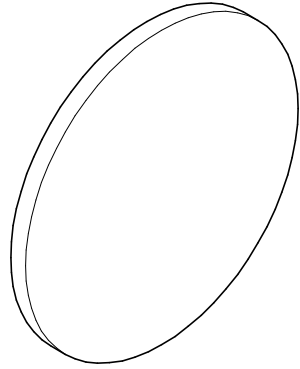

1

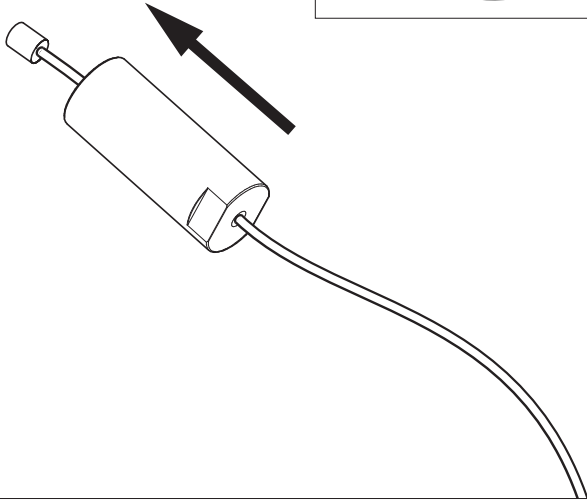
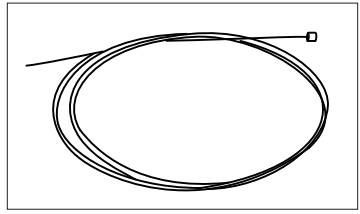

2

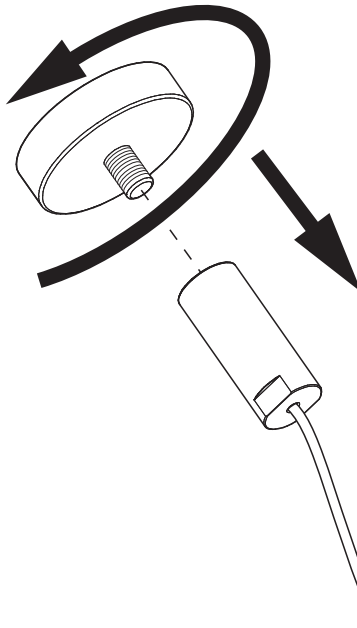

3

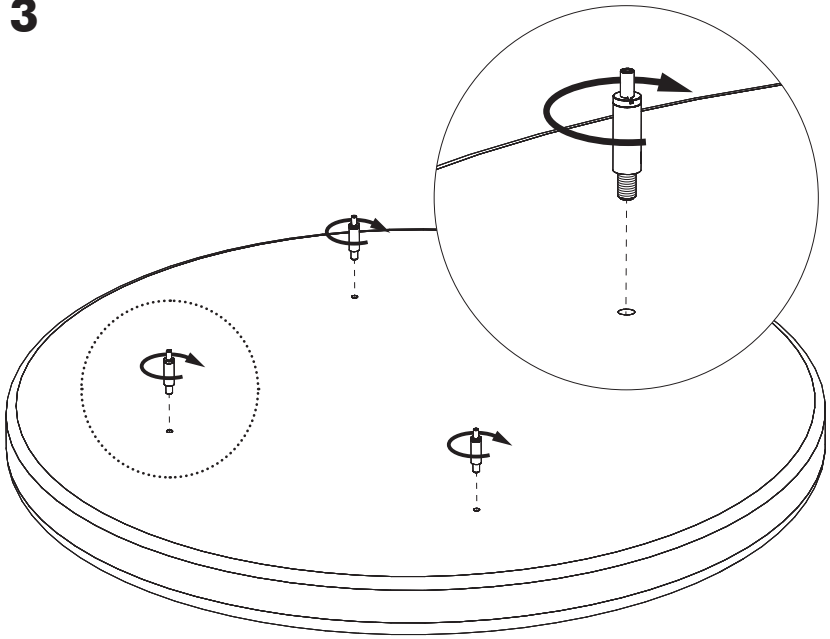

4

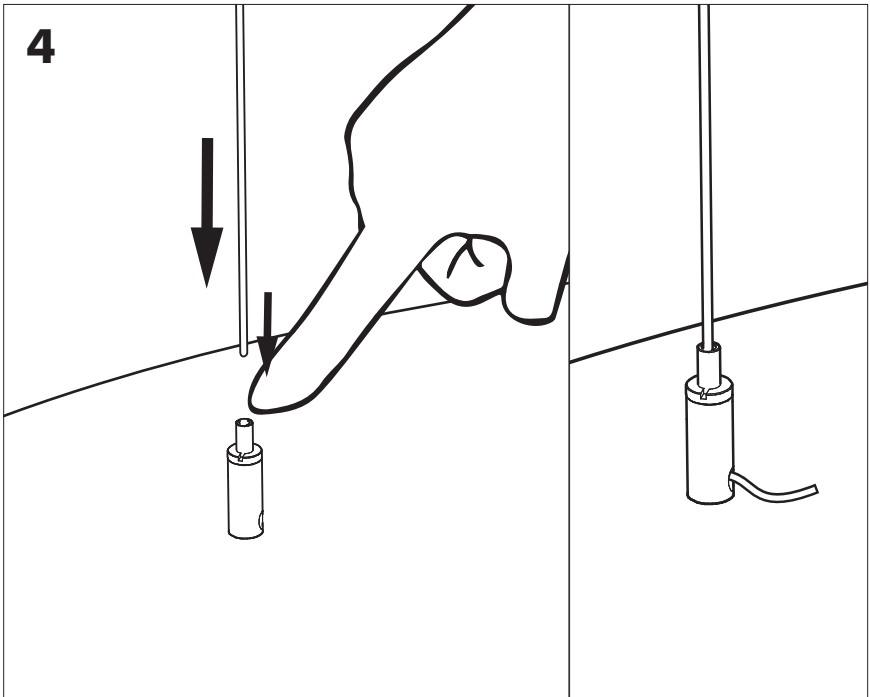

5

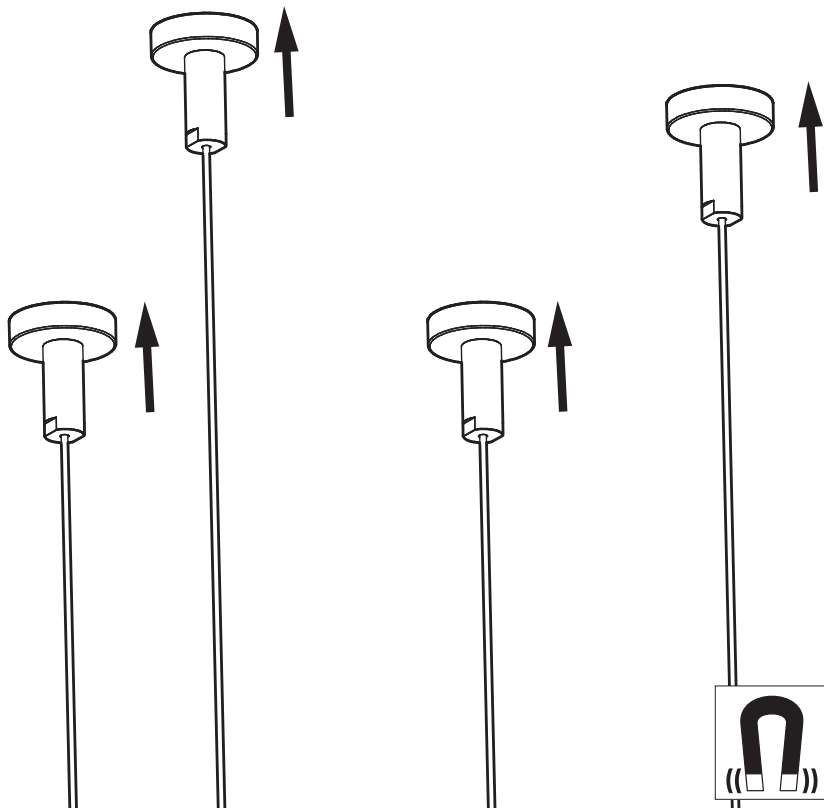

6

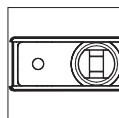
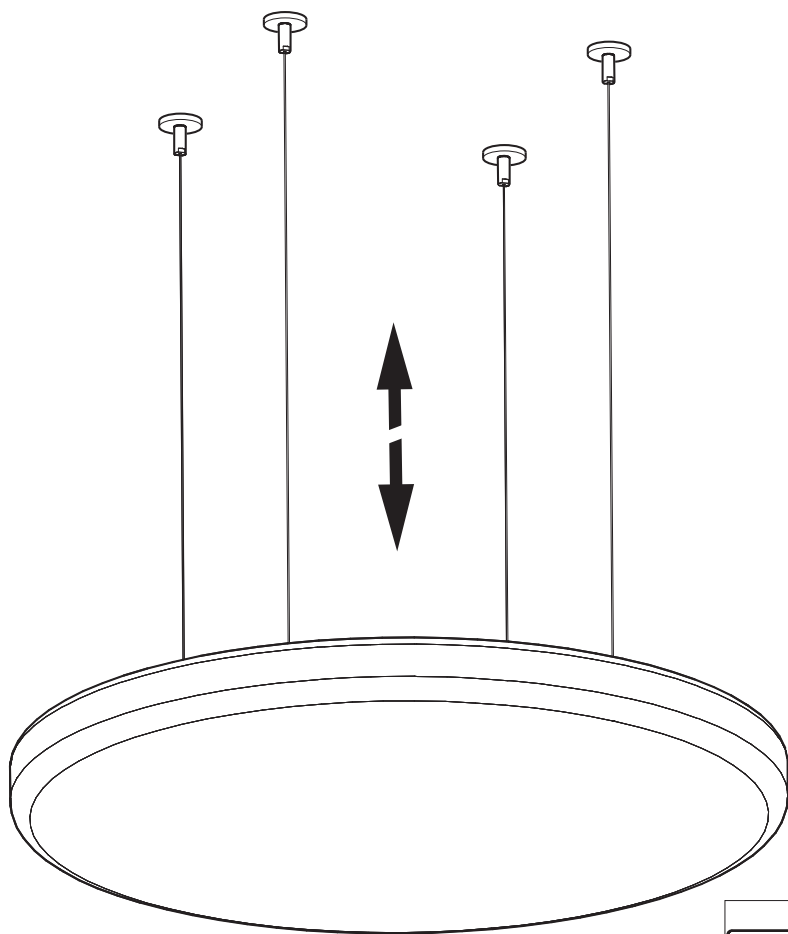
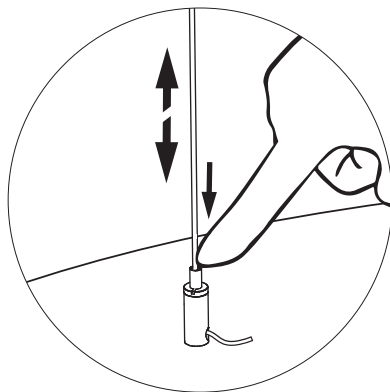

BuzziSpace Group NV
Italiëlei 8, 2000 Antwerp
Belgium

☎ +32 (0)3 846 10 00

✉ info@buzzi.space

🌐 www.buzzi.space



Doc nr.: A-0000001569/03

Last update: 04/12/2023