



[HERMAN MILLER COLLECTION](#)

[ABOUT](#)

[DESIGNERS](#)

[CRAFTSMANSHIP](#)

[MATERIALS](#)

[PRODUCTS](#)

Herman Miller Collection

February 2019

HERMAN MILLER COLLECTION

**“A permanent collection,
designed to fully meet
the requirements of
modern living.”**

George Nelson's vision for the Herman Miller Collection, 1952



HERMAN MILLER COLLECTION

About The Collection

As the first Director of Design for Herman Miller from 1946 to 1972, George Nelson defined a straightforward set of principles that guided the company then as now:

1. What we make is important
2. Design is an integral part of the business
3. The product must be honest
4. We decide what we make
5. There is a market for good design

Putting the philosophy into action, and first articulated in his introduction to the 1948 Herman Miller Collection catalogue. It draws on Nelson's vision by offering a carefully chosen selection of products to furnish environments in a myriad of settings, both elegant and casual.

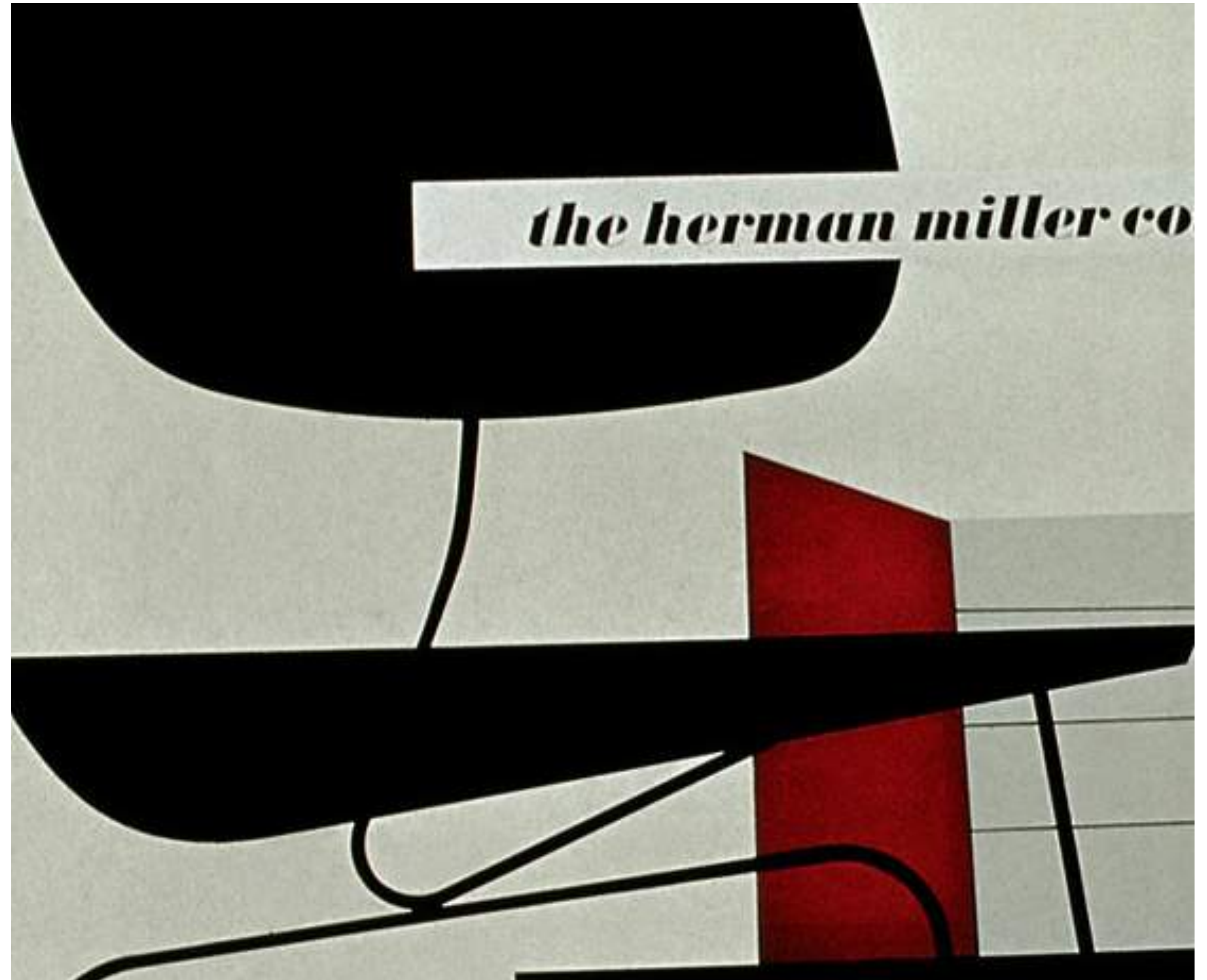

The Herman Miller Collection Catalogue, 1948

HERMAN MILLER COLLECTION

Designers

In 1952 George Nelson noted that the Collection “is strengthened by the participation of a group of designers who share Herman Miller’s particular attitudes.” With that in mind, today’s Herman Miller Collection presents updated archival offerings as well as new designs from today’s top talent – a bridge between our past, present, and future.

You’ll find designs from the 1960s by Ward Bennett juxtaposed with pieces by Bruce Burdick from the 1980s anchored effortlessly by furnishings from today by Sam Hecht & Kim Colin, EOOS, Vincent van Duysen and Michael Anastassiades. Seen together, in every type of environment, you realise they speak the same language, and that they are built from the same set of timeless design principles that have guided Herman Miller from the start.



Ward Bennett



Sam Hecht & Kim Colin

HERMAN MILLER COLLECTION

Craftsmanship

The enduring designs of the Herman Miller Collection strike a balance between seemingly contradictory ideas: aspiration and accessibility, sculpture and engineering, elegance and informality, beauty and comfort. Not the least of these is its delicate balance of craft and industrial processes. The Collection moves forward by utilising the latest technologies and best materials available.

But it remains grounded in the quality and value produced by the craftsmanship, thoughtfulness, and individual human touch of the workers who assemble many of its pieces by hand. These details make a difference. As Charles Eames said, “The details are not details. They make the product.”



HERMAN MILLER COLLECTION

Materials

Materials in the Collection amplify its design philosophy of elegant pragmatism and industrial craft. State-of-the-art textiles build on decades of learning and investigation, with carefully chosen materials that utilise new technologies or embrace the ties to our design heritage.

With an emphasis on practicality and beauty, the materials selected for use in the Collection are chosen to best serve the product, and thus the user.



Products

Lounge Seating



Executive & Side Seating



Stools



Benches



Tables



Accessories



Prices shown in this document are correct at time of going to print but are subject to change at any time and without notice from Herman Miller.

Prices do not include VAT, which will be added where applicable (if you cannot supply a valid EU VAT registration number in the country of supply), otherwise no VAT is applicable. Although every effort is made to maintain accuracy, we regret we are unable to honour any incorrect prices or other details that may have been printed.

Lounge Seating



HERMAN MILLER COLLECTION

Lounge Seating



Brabo Lounge Seating
2-Seat Sofa



Brabo Lounge Seating
3-Seat Sofa



Brabo Lounge Seating
Club Chair



Chadwick Modular Seating



ColourForm Sofa Group
Chaise



ColourForm sofa Group
Tête-à-Tête



2.ColourForm Sofa Group
Club Chair



ColourForm Sofa Group
3-Seat Sofa



2.ColourForm sofa Group
2-Seat Sofa



2.ColourForm sofa Group
Ottoman



Crosshatch
Lounge Chair & Ottoman



Goetz Sofa



Rolled Arm Sofa Group
2-Seat Sofa



Rolled Arm Sofa Group
3-Seat Sofa



Rolled Arm Sofa Group
4-Seat Sofa



Rolled Arm Sofa Group
Club Chair



Saiba Lounge Chair & Ottoman



Scissor Chair



Setu Lounge Chair & Ottoman



Sled Chair



Striad Lounge Chair
High Back



Striad Lounge Chair
Mid Back



Striad Lounge Chair
Low Back



Striad Ottoman



Tuxedo Lounge Seating
2-Seat Sofa With Arms



Tuxedo Lounge Seating
2-Seat Sofa Without Arms



Tuxedo Lounge Seating
3-Seat Sofa With Arms



Tuxedo Lounge Seating
3-Seat Sofa Without Arms



Tuxedo Lounge Seating
Club Chair With Arms



Tuxedo Lounge Seating
Club Chair Without Arms



Tuxedo Lounge Seating
Corner Sofa with Attached Settee



Wireframe Sofa Group
2-Seat Sofa



Wireframe Sofa Group
3-Seat Sofa



Wireframe Sofa Group
Club Chair



Wireframe Sofa Group
Ottoman



LOUNGE SEATING

Brabo Lounge Seating

Designed by Vincent Van Duysen, 2013

For the Brabo Lounge family, his first design commission for Herman Miller, Belgian architect Vincent Van Duysen has created a sophisticated line of modern classics. Named after a Dutch folk hero celebrated in Van Duysen's hometown of Antwerp, the collection deftly blends fine materials like wood, metal, and leather and fabric upholstery to create a timeless collection of seating and table offerings.

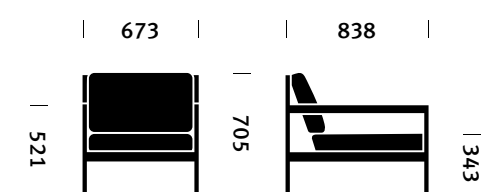

Club Chair

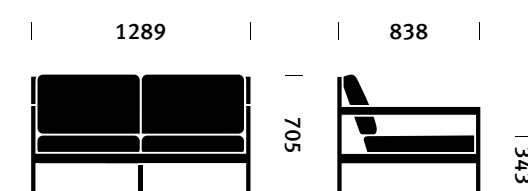

2-Seat Sofa

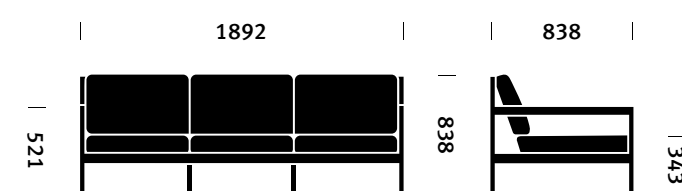

3-Seat Sofa

LOUNGE SEATING

ColourForm Sofa Group

Designed by Scholten & Baijings, 2016

ColourForm Sofa Group is a collection that builds welcoming lounge landscapes from a vocabulary of pieces that support the way people want to work and live today. Individual components can stand alone or work together to build privacy or community, for work, play, or rest, in commercial or residential spaces.

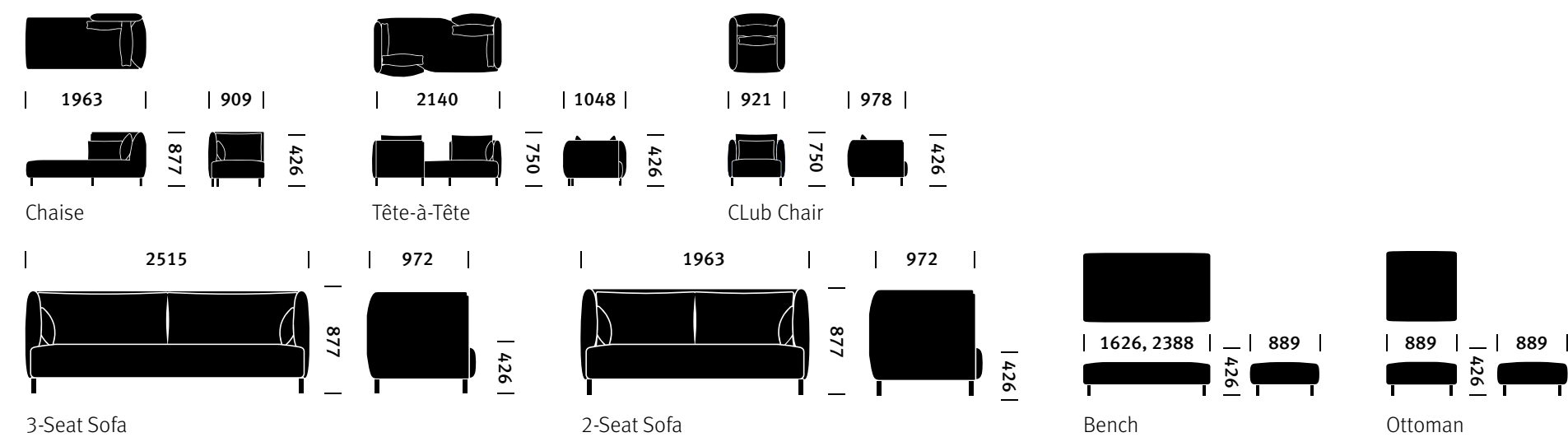

LOUNGE SEATING

Chadwick Modular Seating

Designed by Don Chadwick, 1974

Chadwick Modular Seating embodies the ideal benefit of a modular system: vast variety from just a few parts. Its five units can be arranged – and rearranged – in a multitude of forms to meet a variety of needs. Originally designed in 1974, and now updated with a contemporary seat height, it remains one of the most versatile and enduring lounge furniture options available.

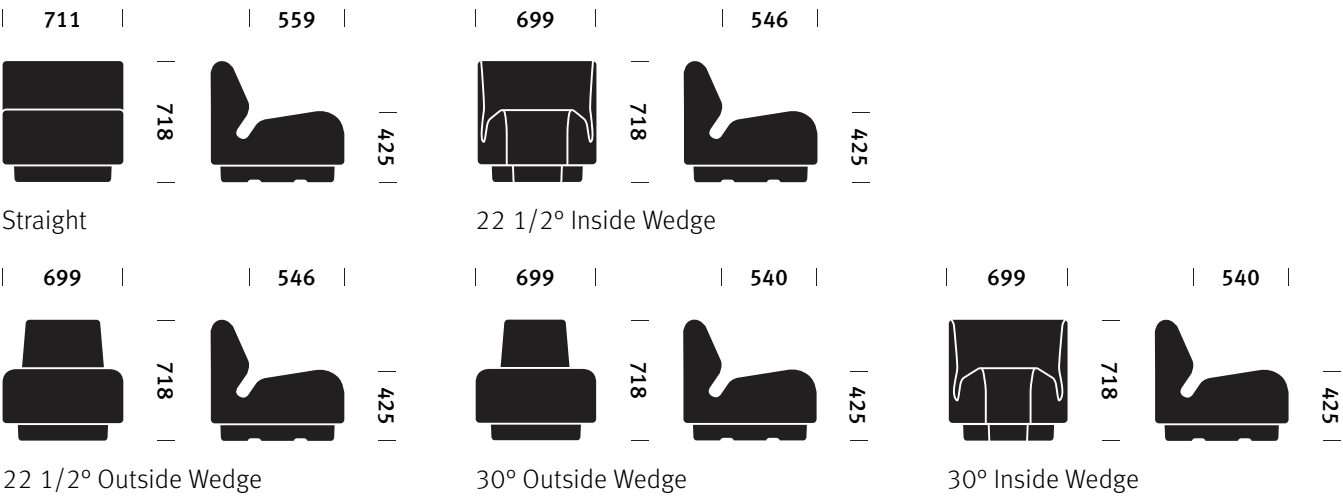

LOUNGE SEATING

Crosshatch Lounge Chair & Ottoman

Designed by EOOD Studio, 2014

Designed by Vienna-based EOOD Studio, the Crosshatch Lounge chair is the very definition of versatile. Lightweight and transparent the design employs both handcrafting and technology in its production, using a minimum of materials in surprising ways. The parachute cord is available in four colours; the frame in either an ash or walnut in a range of textiles.

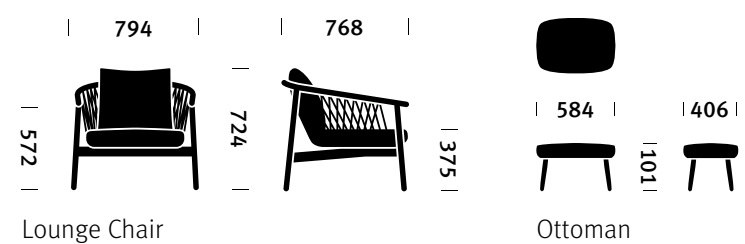

LOUNGE SEATING

Goetz Sofa

Designed by Mark Goetz, 1999

Mark Goetz turns traditional sofa design inside out, wrapping thick cushions in a striking moulded wood shell, creating both a structural frame and a dramatic profile. Comfortable and beautiful from all angles, the sofa offers a wide array of options for combining veneers, upholstery, and accent materials to allow the versatile design to precisely fit a range of environments.



LOUNGE SEATING

Rolled Arm Sofa Group

Designed by Ward Bennett, 1970

A modern version of the classic chesterfield—Ward Bennett’s Rolled Arm Sofa Group has universal appeal. Its generous, low-slung, architecturally scaled volumes and crisply mitered upholstery provide a graceful silhouette. The sofa is perched on recessed solid wood legs, produced in walnut or ash.

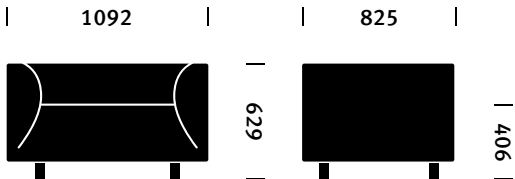

Club Chair

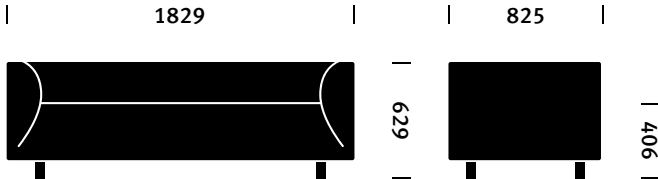

2-Seat Sofa

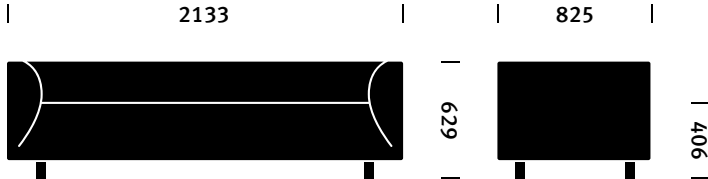

3-Seat Sofa

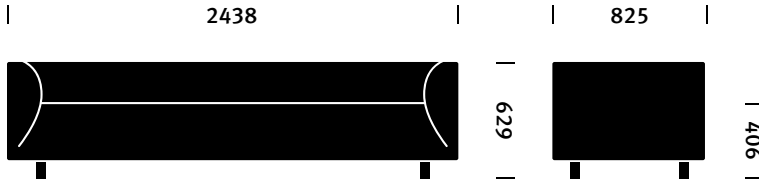

4-Seat Sofa

LOUNGE SEATING

Saiba Lounge Chair & Ottoman

Designed by Naoto Fukasawa, 2015

The Saiba Lounge Chair & Ottoman exemplifies the sophisticated simplicity of Tokyo-based designer Naoto Fukasawa. With a thoughtfully sculpted silhouette, the design subtly elevates the atmosphere around it while providing an effortless sense of comfort to the person sitting in it.

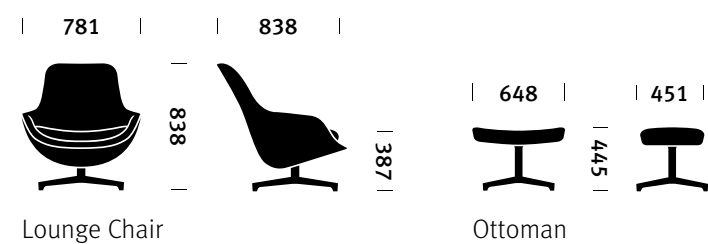

LOUNGE SEATING

Scissor Chair

Designed by Ward Bennett, 1964

The hammock-style chaise transatlantique, the deck chair popular on ocean liners of the past, inspired this chair's minimalist design. With a wide array of wood or metal finishes and upholstery options, it comfortably combines unique aesthetics and functional portability to make a dramatic statement in any space.

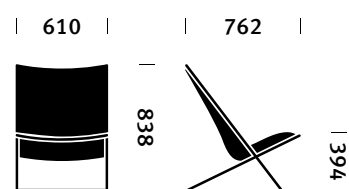

LOUNGE SEATING

Setu Lounge Chair & Ottoman

Designed by Studio 7.5, 2009

Studio 7.5's lounge chair is a remarkable combination of flex, strength, and style thanks to its Kinematic Spine™ and hardworking Lyris 2™ fabric, which provides support, air flow, and a distinctive sheen. Working in concert with the spine, the material distributes weight evenly and conforms to body contours.

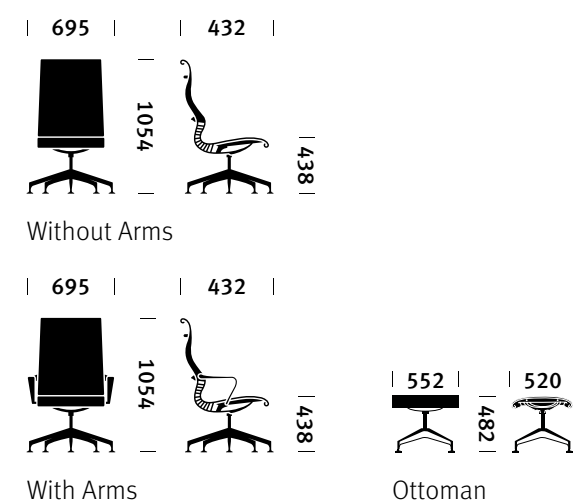

LOUNGE SEATING

Sled Chair

Designed by Ward Bennett, 1963

This timeless design by Ward Bennett draws the eye downward to its distinctive base, a straightforward X shape welded from tubular steel and mounted on parallel rails. Its comfortable seat and back cradle the sitter. Elegant without being showy, it can be upholstered in most textile or leather options to suit private and public spaces alike.

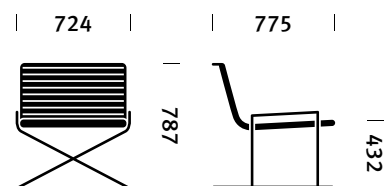

LOUNGE SEATING

Striad Lounge Chair & Ottoman

Designed by Jehs & Laub, 2016

With its distinct presence, sleek and contoured form, and premium comfort, the Striad Lounge Chair and Ottoman contemporise the concept of a lounge chair. Inspired by the construction of a ski boot, designers Markus Jehs and Jürgen Laub designed Striad in layers. The rigid outer shell provides stability and support while a softer inner shell offers flexion to welcome the body. Available in three different back heights and two different base finishes.

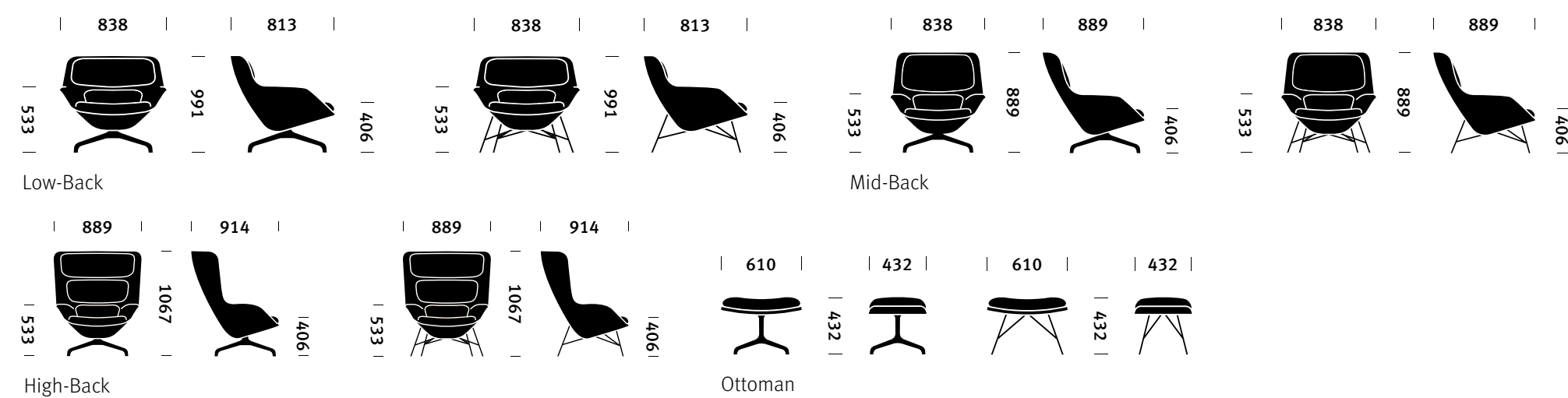

LOUNGE SEATING

Tuxedo Lounge Seating

Designed by BassamFellows, 2011

This component lounge portfolio by BassamFellows showcases a crisply tailored seat and back cantilevered on slim steel legs. Sleek and carefully considered, it anchors a space without overpowering it. The seating, which pairs with other designs and tables in the Tuxedo line, comes with or without arms and offers a variety of finishes.

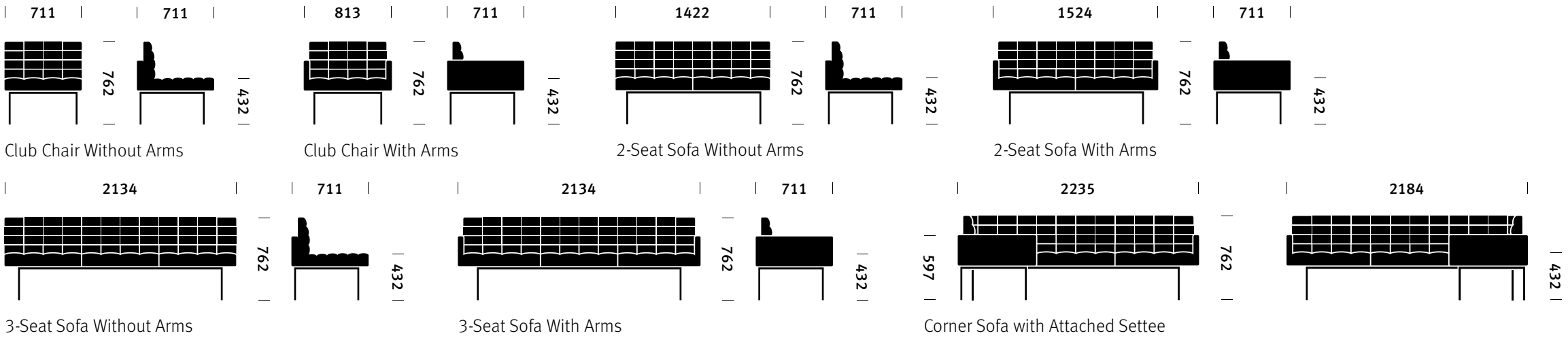

LOUNGE SEATING

Wireframe Sofa Group

Designed by Sam Hecht & Kim Colin, 2012

Visually speaking of softness and volume contained within a formal frame, the Wireframe Sofa Group exemplifies a recurring theme for designers Sam Hecht and Kim Colin: contrasting tension. The design's external structure is shaped from steel wire. Held within the frame are contoured cushions, which find added comfort from a suspension technology first developed by Herman Miller for the healthcare industry.

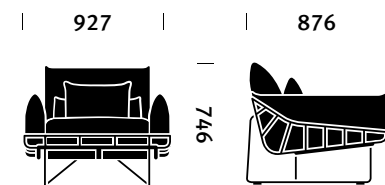

Club Chair

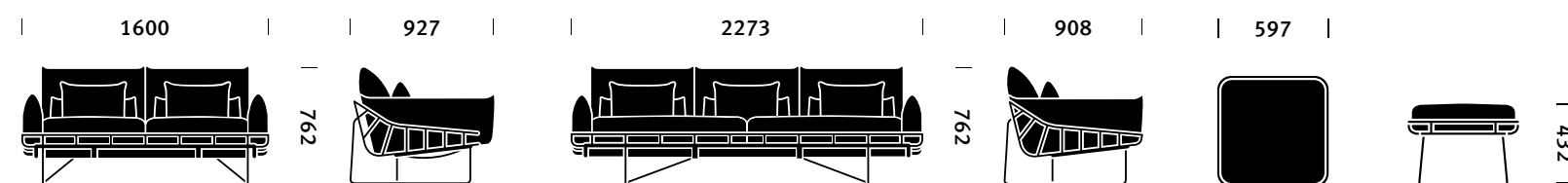

2-Seat Sofa

3-Seat Sofa

Ottoman

Executive and Side Seating



HERMAN MILLER COLLECTION
Executive and Side Seating



Bumper Chair
4-Leg



Bumper Chair
4-Star



Bumper Chair
5-Star with Castors



Crosshatch
Side Chair



Envelope Chair



Full Twist Guest Chair



Landmark Chair



Landmark Chair
Low Arm



Leeway Chair



Nessel Chair
With Arms



Nessel Chair
Without Arms



Saiba Side Chair



Saiba Conference Chair
Low Back



Saiba Conference Chair
High Back



Saiba Multitask Chair
Low Back



Saiba Multitask Chair
High Back



Taper Chair

EXECUTIVE AND SIDE SEATING

Bumper Chair

Designed by Ward Bennett, 1964

A modern update on the classic bucket seat, Ward Bennett's Bumper Side Chair delivers comfort and class in its deceptively simple, and nearly seam free design. Originally introduced in 1964, the chair is equally relevant today, with a robust portfolio of options for textiles and leather upholsteries and base finishes.

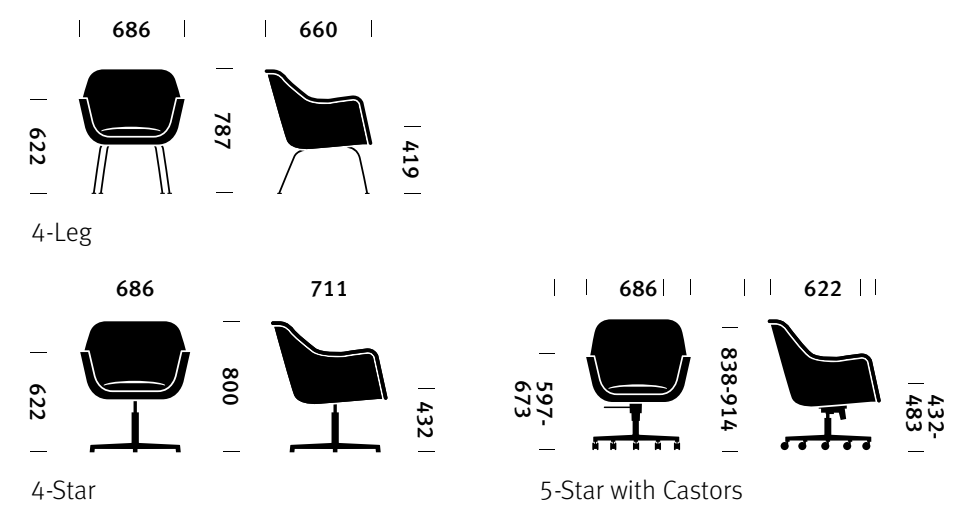

EXECUTIVE AND SIDE SEATING

Crosshatch Side Chair

Designed by EOOOS Studio, 2014

Designed by Vienna-based EOOOS Studio, the Crosshatch Side Chair brings a minimalist refinement to interiors. Lightweight and comfortable, its gently sculpted form accentuates the inherent beauty of its materials.

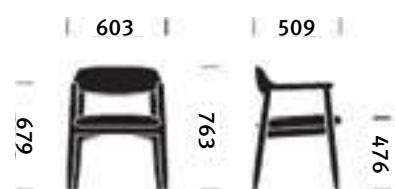

EXECUTIVE AND SIDE SEATING

Envelope Chair

Designed by Ward Bennett, 1966

Like Ward Bennett’s other timeless designs, this chair is subtle and sophisticated. Upholstery wraps the welded tubular steel frame to create the seat, sides, and back. Likewise, the chair wraps around the sitter, and is comfortable for office environments.

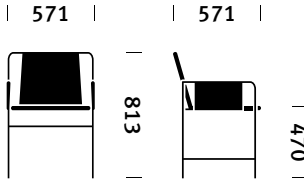

EXECUTIVE AND SIDE SEATING
Full Twist Guest Chair

Designed by Mark Goetz, 2010

Refined and confident, this chair appears to have a frame formed from flowing ribbons of wood— an illusion produced by carpentry craft and cutting-edge technology. This singular wood band seamlessly attaches to the legs, forming armrests and a sloping back to provide natural comfort.

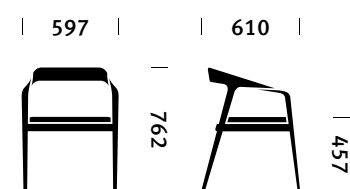

EXECUTIVE AND SIDE SEATING

Landmark Chair

Designed by Ward Bennett, 1964

Stately and softly curved, this design represents one of Ward Bennett's most well-known pieces of work. Carved from solid hardwood, its classic English form is both light in scale and durable. Available in a range of upholstery variations, it offers style and comfort in the office.

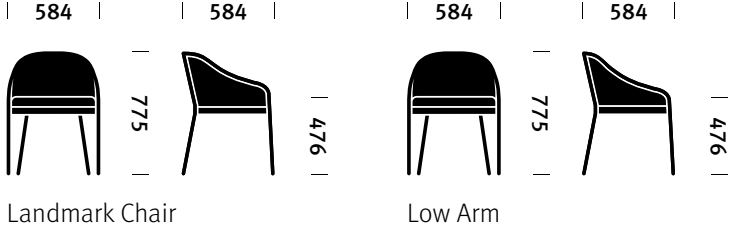

EXECUTIVE AND SIDE SEATING

Leeway Chair

Designed by Keiji Takeuchi, 2018

Leeway Seating maximizes freedom of movement in a minimal footprint. Leveraging Geiger’s strength in woodcraft, designer Keiji Takeuchi gave these side chairs a crescent shaped, cantilevered backrest that allows people to move naturally as they sit to collaborate or socialize. Leeway metal side chairs can be stacked up to three-high.

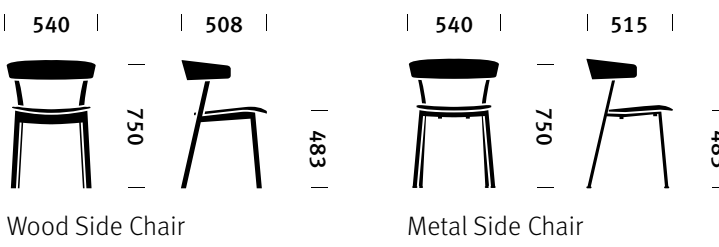

EXECUTIVE AND SIDE SEATING

Nessel Chair

Designed by Vincent Van Duysen, 2014

This Side Chair, available with or without arms, is produced in either solid ash or solid walnut and is upholstered in Geiger textiles in two versions: fully upholstered in fabric or leather or in two contrasting fabrics. It is designed with maximum comfort in mind. Its timeless style makes it equally appropriate for residential or office settings.

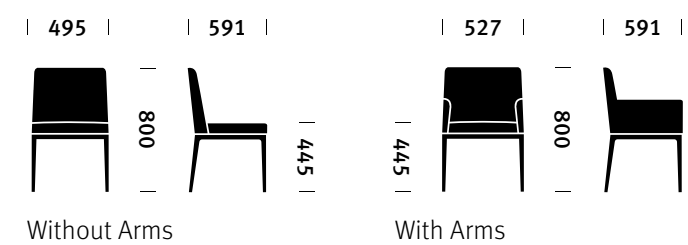

EXECUTIVE AND SIDE SEATING

Saiba Chair

Designed by Naoto Fukasawa, 2015

The Saiba chair exemplifies the sophisticated simplicity of Tokyo-based designer Naoto Fukasawa. With a thoughtfully sculpted silhouette, the design subtly elevates the atmosphere around it while providing an effortless sense of comfort to the person sitting in it. The result is a range of executive and lounge seating that is intuitively beautiful and useful.

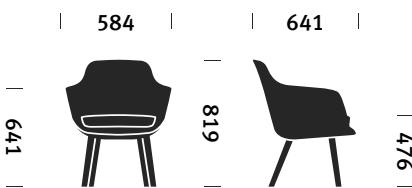

Side Chair

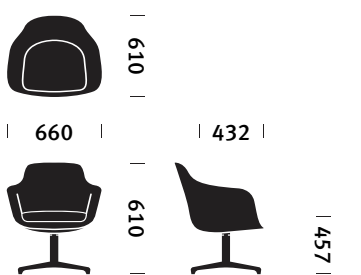

Conference Chair Low Back

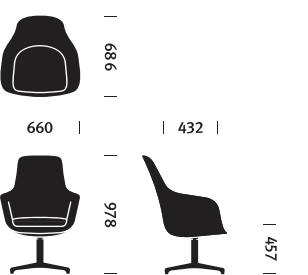

Conference Chair High Back

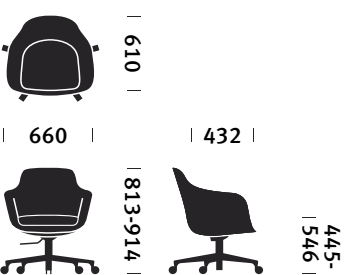

Multitask Chair Low Back

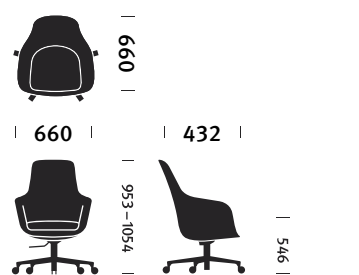

Multitask Chair High Back

EXECUTIVE AND SIDE SEATING

Taper Chair

Designed by Mark Goetz, 2017

The result of a collaboration between designer Mark Goetz and longtime Herman Miller seating advisor Dr. Brock Walker, the Taper Chair combines Herman Miller's depth of knowledge in ergonomics with Geiger's core strength in quality construction and craft in one clean, sophisticated design.

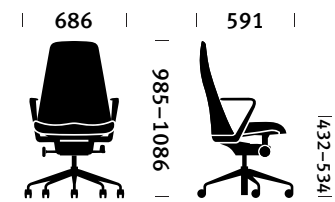

Conference Chair Low Back

Stools



HERMAN MILLER COLLECTION

Stools



Crosshatch
Stool



Leeway Stool



Spot Stool
Bar Height



Spot Stool
Counter Height



Spot Stool
Occasional Height

STOOLS

Crosshatch Stool

Designed by EOOO Studio, 2014

Designed by Vienna-based EOOO Studio, the graceful lines and rounded edges of the Crosshatch Stool highlight the inherent beauty of wood. With just a hint of a backrest, the seat provides an inviting perch. The backrest doubles as a handle, making it easy to grasp and move around. Available in a variety of different wood finishes.



STOOLS

Leeway Stool

Designed by Keiji Takeuchi, 2014

Like the Leeway Chair, Leeway Stools maximize freedom of movement within a minimal footprint. The curved, cantilevered backrest follows the shape of the human body and contributes to an open design that accommodates the side-to-side movements seated people make while socializing or collaborating.

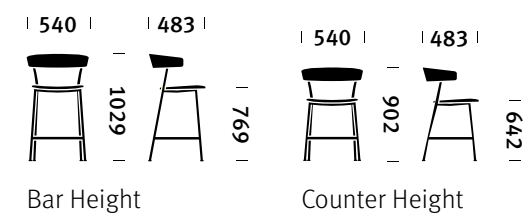

STOOLS

Spot Stool

Designed by Michael Anastassiades, 2016

Spot Stools have a purity of form and an honesty of materials that have become the signature of their designer, Michael Anastassiades. A circular seat and base are held together by two parallel legs in the kindred pairing of wood and metal. Offered in three heights, with the two tallest outfitted with a crossbar footrest, Spot Stools bring an austere sense of elegance to an interior.

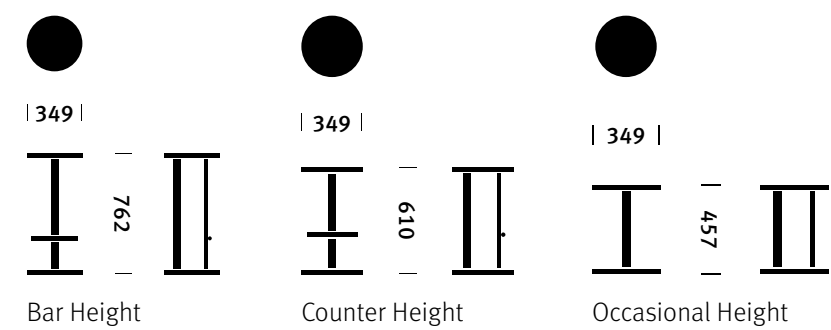

Benches



HERMAN MILLER COLLECTION

Benches



2.ColourForm sofa Group Bench



Tuxedo Lounge Seating Single Seat Bench



Tuxedo Lounge Seating 2-Seat Bench



Tuxedo Lounge Seating 3-Seat Bench

BENCHES

Tuxedo Lounge Seating

Designed by BassamFellows, 2011

Designed to offer a generous platform for seating without visually overpowering their surroundings, Tuxedo Benches are precisely proportioned and exquisitely detailed. They are based on a modular grid that accommodates designs ranging from a one-seat ottoman to an expansive museum bench. The grid also allows for any Tuxedo Sofa to be easily coupled with other pieces in the Tuxedo range, including lounge seating and sofas.

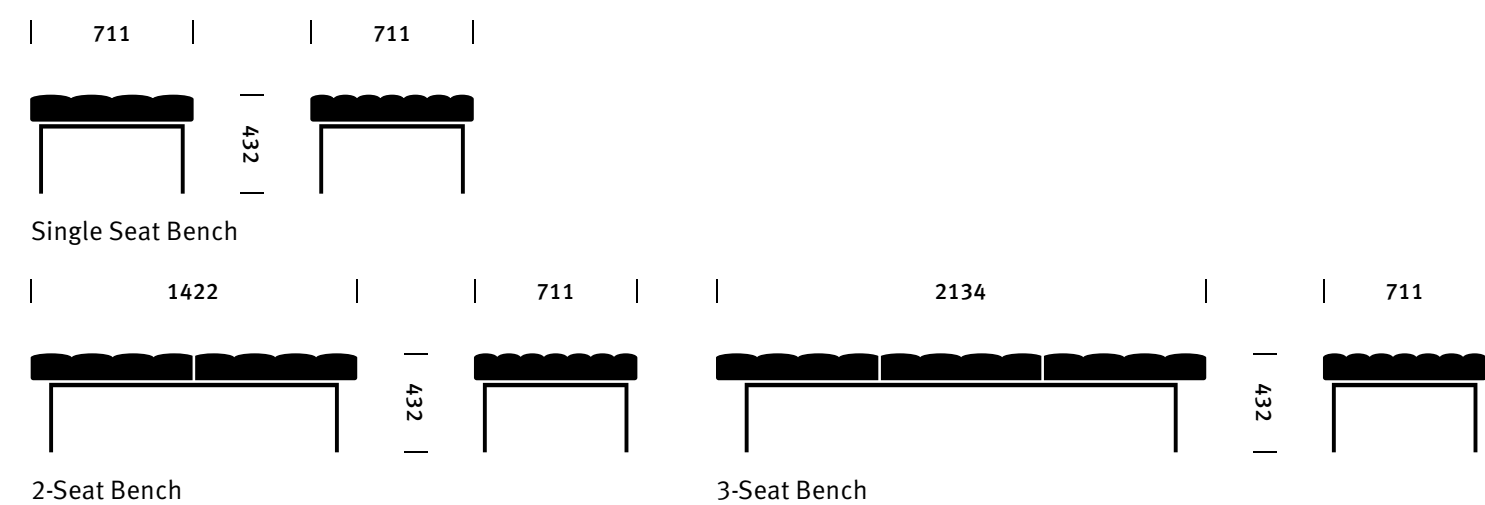

Tables



HERMAN MILLER COLLECTION

Tables



AGL Table Group



Brabo Table Coffee



Brabo Table Side



Burdick Table Group



H Frame Table Coffee



H Frame Table Side



I Beam Table Coffee



I Beam Table Side



Layer Table Occasional Table with Shelf



Layer Table Occasional Table with Drawer



Layer Table Occasional Table, Nesting



Noguchi Rudder Table



Polygon Wire Table Hexagon Coffee Height



Polygon Wire Table Hexagon Lounge Height



Polygon Wire Table Hexagon Standard Height



Polygon Wire Table Round Coffee Height



Polygon Wire Table Round Lounge Height



Polygon Wire Table Round Standard Height



Polygon Wire Table Triangle Coffee Height



Polygon Wire Table Triangle Lounge Height



Polygon Wire Table Triangle Standard Height



Saiba Table Coffee Height



Saiba Table Lounge Height



Saiba Table Standard Height



Tuxedo Rectangle Two Piece Table



Tuxedo Square Table



Tuxedo Rectangle Table



TABLES

AGL Table Group

Designed by Leon Ransmeier, 2012

Highly considered in shape, proportion, and scale, the AGL Table Group minimises material usage—an approach that draws from the efficiencies of aeronautical design. Many size and material options make it suitable for use as a dining table or a conference table, or any gathering place in need of an elegant surface.

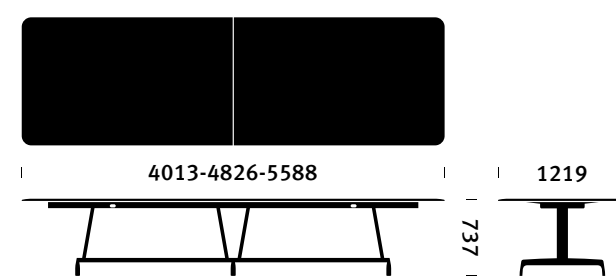

Double Top

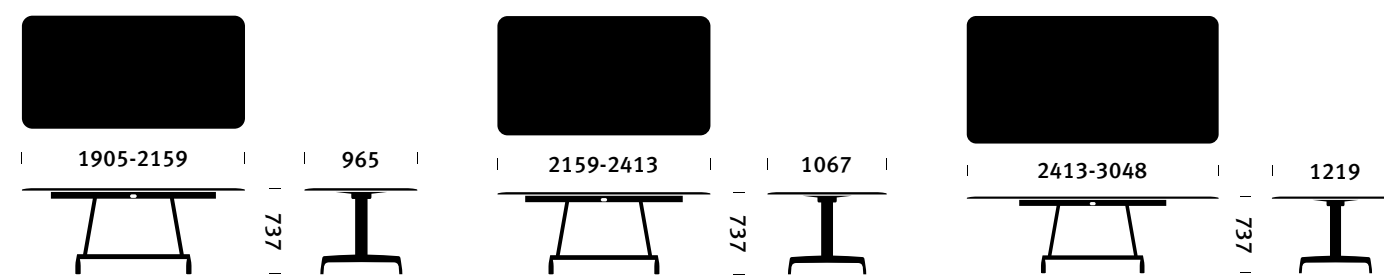

Single Top

TABLES

Brabo Table

Designed by Vincent Van Duysen, 2013

For the Brabo Lounge family, his first design commission for Herman Miller, Belgian architect Vincent Van Duysen has created a sophisticated line of modern classics. Named after a Dutch folk hero celebrated in Van Duysen's hometown of Antwerp, the collection deftly blends fine materials like wood, metal, and leather and fabric upholstery to create a timeless collection of seating and table offerings.

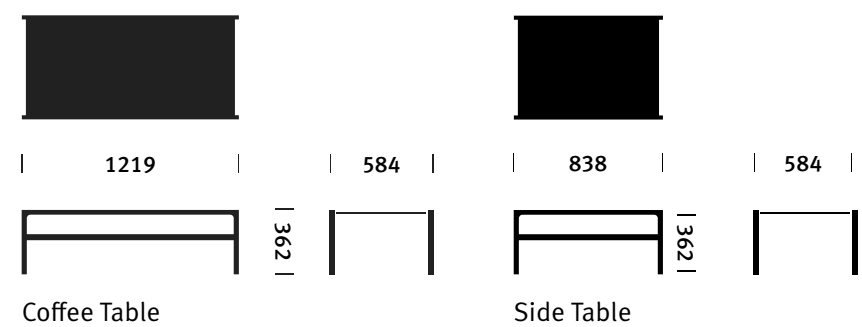

TABLES

Burdick Table Group

Designed by Bruce Burdick, 1980

Sophisticated, distinctive, and highly functional, the Burdick Table Group is built around a dramatic, central aluminum beam. A clear glass surface showcases the table's understructure, so that beauty and purpose are equally part of any gathering, whether to dine, to work, or to converse.

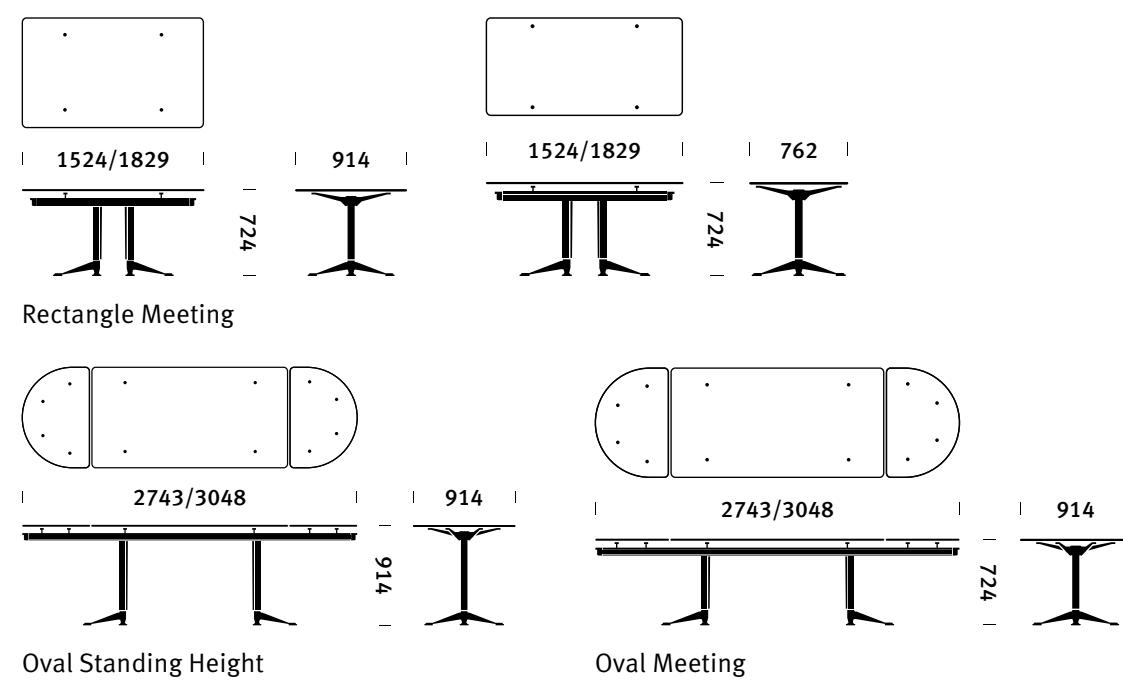

TABLES

H Frame Table

Designed by Ward Bennett, 1963

A sophisticated design of precise proportions and details, Ward Bennett's coffee and side table suits a variety of environments, from executive offices to elegant living areas. The minimal form allows the design's natural materials to come to the fore. Tops are available in a range of wood, or glass, and its metal frame comes in three different finishes.

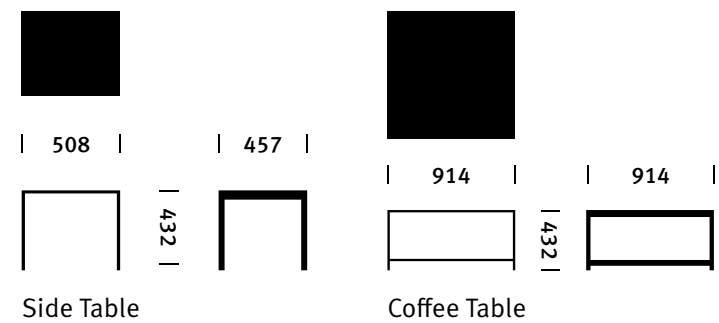

TABLES

I Beam Table

Designed by Ward Bennett, 1963

Precise angles and a solid demeanor make this Ward Bennett design a versatile pedestal or side table for any home or office environment. Crafted from powder-coated cast aluminium and available in two sizes, plus a Side Table without glass, it gracefully pays tribute to 20th-century architecture and industrial utility

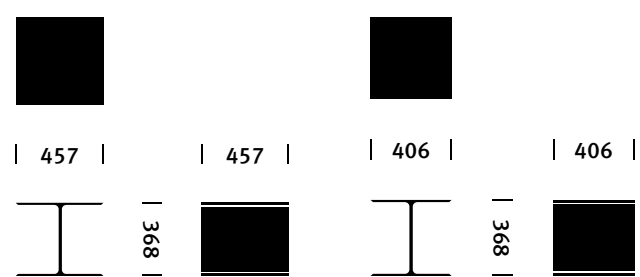

Side Table

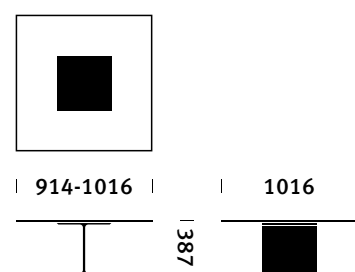

Coffee Table

TABLES

Layer Table

Designed by BassamFellows, 2017

Scaled to complement sophisticated soft seating lines, glass topped Layer Tables feature secondary shelves in stone or wood visible through the tabletop. The collection's natural materials, soft curves, and subtle detailing evoke a sensuality common to other BassamFellows designs.

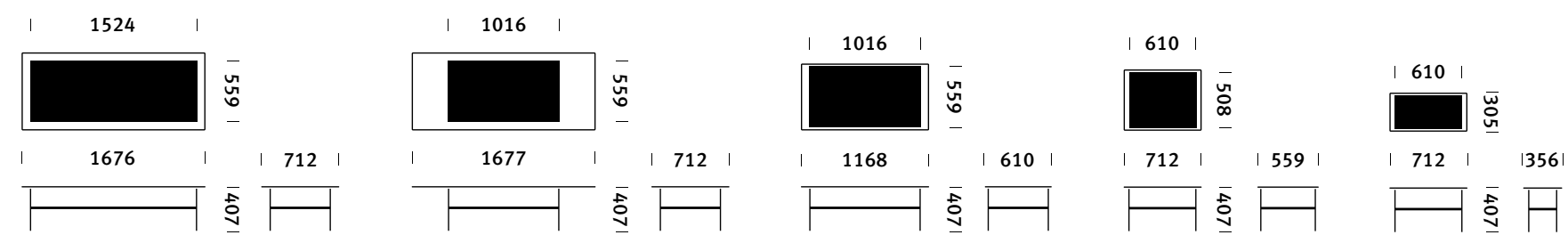

Occasional Table with Shelf

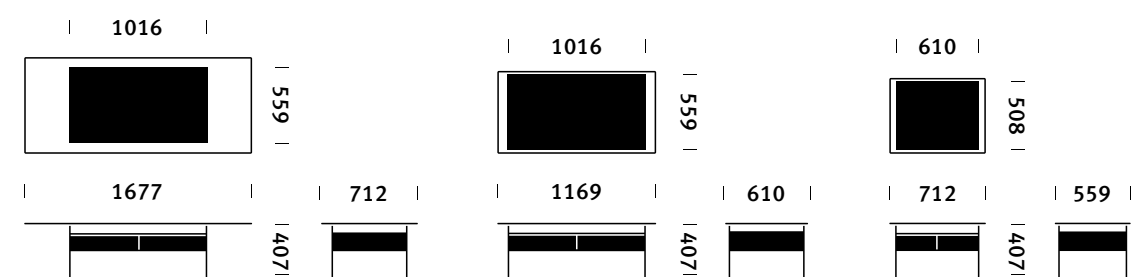

Occasional Table with Drawer

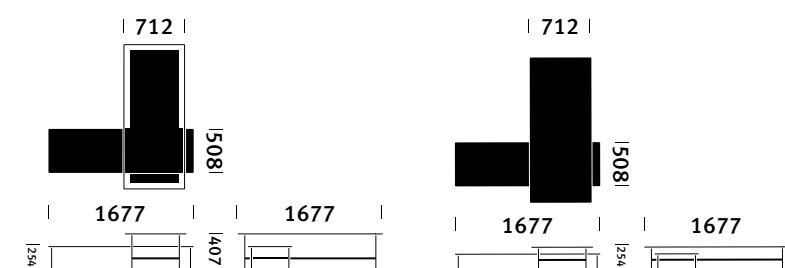

Occasional Table, Nesting

TABLES

Noguchi Rudder Table

Designed by Isamu Noguchi, 1948

An updated archival piece from 1948, this sculptural and deceptively simple coffee table by Isamu Noguchi stands on two chrome hairpin legs and one in wood reminiscent of a ship's rudder. Graceful and visually light, it is available in walnut, ebony, or white ash finish options.

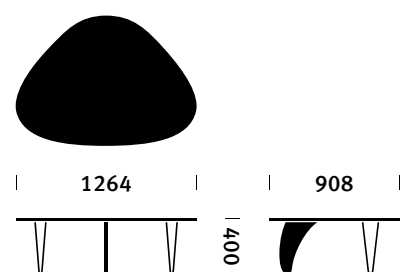

TABLES

Polygon Wire Table

Designed by Studio 7.5, 2015

In their expression of pure geometry, Polygon Wire Tables provide an elegant solution to the need for all manner of surfaces, at home, the office, and elsewhere. The structure of the table's wire base yields a dual advantage: a symmetry of form that uses minimal material for maximum strength and a logical method for scaling up or down in size and height to accommodate various dimensions of round, triangle, and hexagon tops of painted Formcoat. By unifying the colour of base and top—in a choice of black, white, or graphite—a single table has a subtle appearance, and a gathering of tables creates an organic composition.

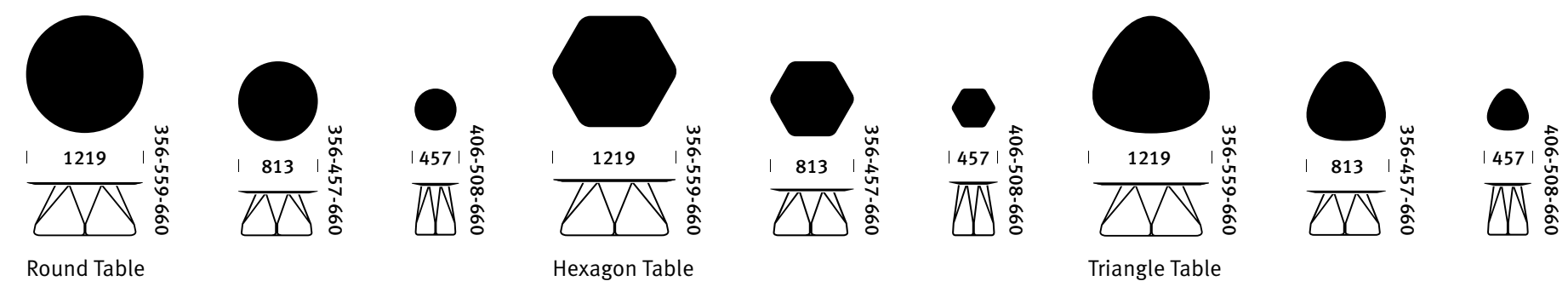

TABLES

Saiba Table

Designed by Naoto Fukasawa, 2016

A thin, elegant surface affixed to a singular pedestal, the Saiba Table bears the minimalist and functional design signature of its designer, Naoto Fukasawa. Offered in a choice of heights and diameters, with a variety of available material options for both surfaces and bases, these occasional tables bring an understated elegance to any space.

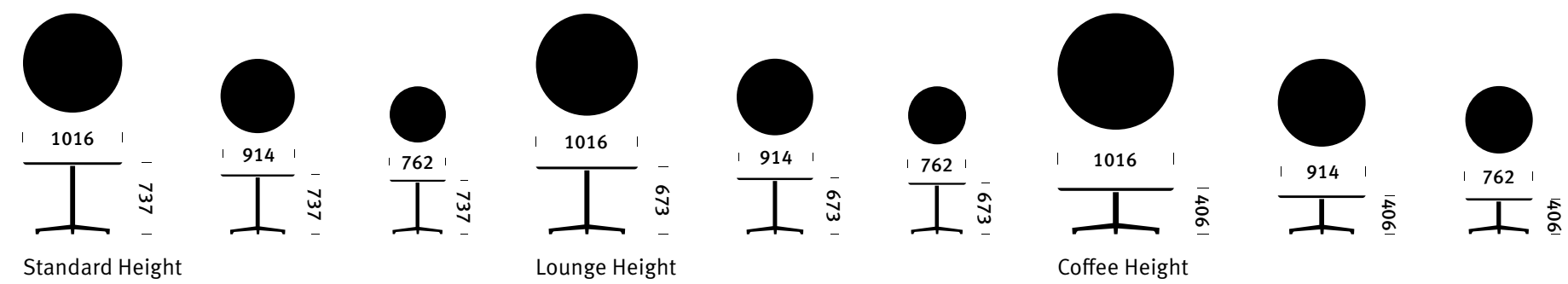

TABLES

Tuxedo Table

Designed by BassamFellows, 2014

Tuxedo Tables have the same pencil thin steel bases as the original Lounge System. The tabletops are veneered panels with a solid wood, carved frame. Smaller trays can be added to nest on the table for serving or to form a layered table surface. Tables come in two sizes in ash or walnut with edges of a carved, solid wood frame.

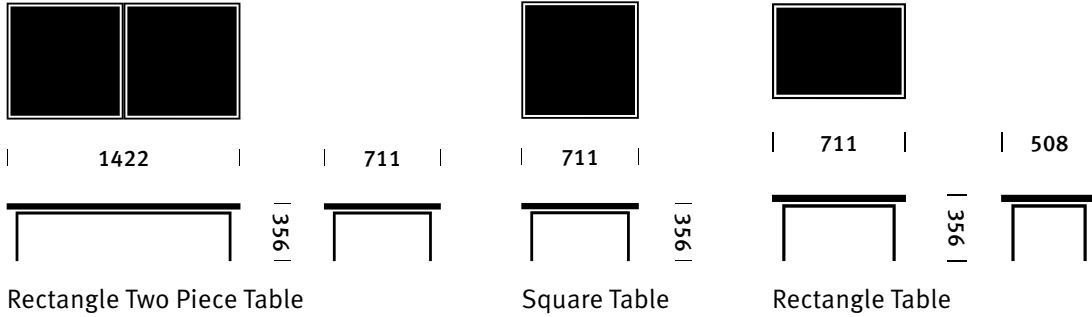

Accessories



HERMAN MILLER COLLECTION

Accessories



Formwork
Large Stationary Box



Formwork
Large Tray



Formwork
Paper Tray



Formwork
Pen Pot



Formwork
Small Stationary Box



Formwork
Small Tray



Formwork
Tissue Box



Nelson Bubble Lamp
Apple



Nelson Bubble Lamp
Ball



Nelson Bubble Lamp
Ball Crisscross



Nelson Bubble Lamp
Bell



Nelson Bubble Lamp
Cigar



Nelson Bubble Lamp
Cigar Crisscross



Nelson Bubble Lamp
Lantern



Nelson Bubble Lamp
Pear



Nelson Bubble Lamp
Pear Crisscross



Nelson Bubble Lamp
Propeller



Nelson Bubble Lamp
Saucer



Nelson Bubble Lamp
Saucer Crisscross



Nelson Bubble Lamp
Triple Fixture



Nelson Bubble Lamp
Ball Wall Sconce



Nelson Bubble Lamp
Cigar Wall Sconce



Nelson Bubble Lamp
Pear Wall Sconce



Nelson Bubble Lamp
Saucer Wall Sconce

ACCESSORIES

Formwork

Designed by Sam Hecht & Kim Colin, 2013

Formwork stackable desktop storage designed by Sam Hecht and Kim Colin helps you bring order to your papers, tools, and artifacts. With shapes and sizes that were rigorously considered to relate an intuitive sense of utility, the accessories may be stacked and combined in any way you see fit.

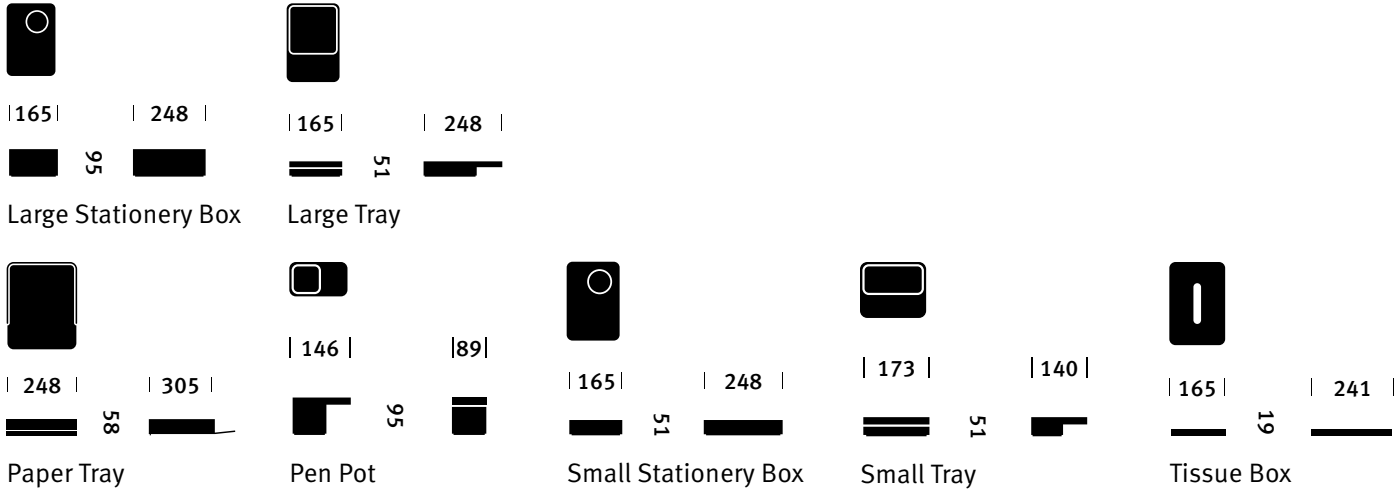

ACCESSORIES

Nelson Bubble Lamps - Pendants & Triple Fixture

Designed by George Nelson, 1952

An assortment of lights in various spherical silhouettes, the Nelson Bubble Lamps add a touch of softness and luminosity to interiors. Designed by George Nelson in 1952, these elegant fixtures are fashioned from a sturdy, lightweight steel frame yet have a delicate, floating quality.

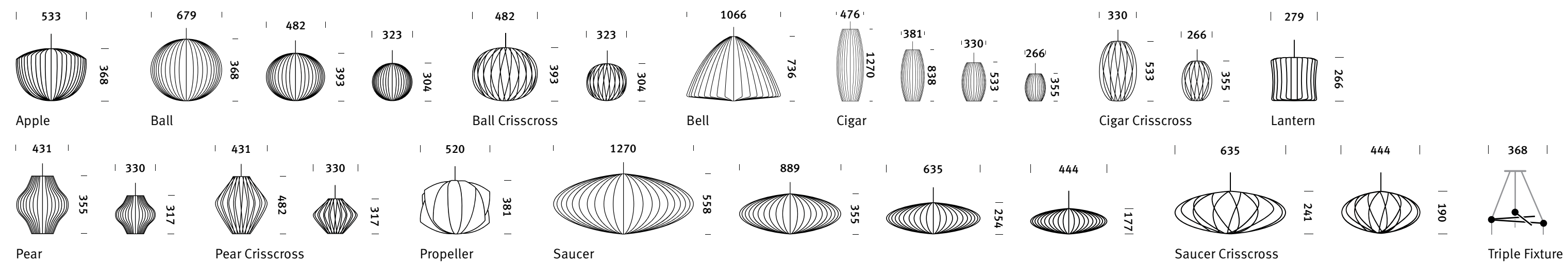

ACCESSORIES

Nelson Bubble Lamps - Wall Sconces

Designed by George Nelson, 1952

Featuring a walnut wall mount and steel arm, this portfolio of wall sconces suspend the shade and let the lamp fill any interior with a warm, diffused light. The lamp's arm can be adjusted from left to right and up and down without having to change its position on the wall.

