



We  
Design  
Colorful  
Life  
Spaces

2025-26

made design





# Index

## Our values

04

- 04 Design and manufacturing
- 06 We are international
- 08 We are from Barcelona
- 10 Customize
- 12 We are green
- 14 Colors

## 01 Recycling

16

- 18 Pictos
- 20 Caps & holes
- 22 Bags



24 Davos



32 Nyon



40 Lausanne



48 Vevey



56 Berna



64 Zurich



74 Basilea



82 Zell



90 Interlaken



98 Baden



106 Thun



114 Biel



122 Winterthur



130 Friburg



138 Lugano



146 Laax

## 02 Planters

154



156 Naka



164 Nipori



172 Kyoto



180 Nyon Plt

## 03 Partitions

188



190 Go



202 Fuji



210 Oslo



218 Nikko

## 04 Contract

226



228 Saga



236 Nagoya



244 Osaka



252 Zao



260 Niseko



268 Menfis



278 Linear



286 Sapporo



294 Albury



302 Obliqua

## 05 Hangers

310



312 Bergamo



320 Milano



328 Siena



336 Padova



344 Torino



352 Napoli



360 Milard



368 Bologna

---

**Designers** 376

---

**Colors & finishes** 388

---

**Downloads** 396

---

**Credits** 398

# Design and manufacturing

---

**In the beginning. That instant, that precise moment, when the pencil creates the first point, when pencil touches paper, from there it accelerates, turns, goes in a straight line, turns again, makes pirouettes, changes its meaning, a double somersault and voilà! So, our designers start to design our products with people in mind and giving them that special touch that fuses form and function.**

**This is what we do, design.**

Al principio. Ese instante, ese preciso momento, cuando el lápiz crea el primer punto, cuando el lápiz toca el papel, de ahí acelera, gira, va en línea recta, vuelve a girar, hace piruetas, cambia de sentido, un doble salto mortal y ¡voilà! Así, nuestros diseñadores empiezan a diseñar nuestros productos pensando en las personas y dándoles ese toque especial que fusiona la forma y función.

Esto es lo que hacemos, diseñar.



*Au début. Cet instant, cet instant précis, où le crayon crée le premier point, où le crayon touche le papier, de là il accélère, tourne, va en ligne droite, tourne encore, fait des pirouettes, change de sens, un double saut périlleux et voilà ! Ainsi, nos designers commencent à concevoir nos produits en pensant aux gens et en leur donnant cette touche spéciale qui fusionne la forme et fonction.*

*C'est ce que nous faisons, concevoir.*

**All'inizio. Quell'istante, quel preciso istante, quando la matita crea il primo punto, quando la matita tocca la carta, da lì accelera, gira, va in linea retta, gira ancora, fa piroette, cambia significato, un doppio salto mortale e voilà! Quindi, i nostri designer iniziano a progettare i nostri prodotti pensando alle persone e dando loro quel tocco speciale che fonde la forma e funzione.**

**Questo è quello che facciamo, progettiamo.**

# We are international

---

**From our beginning to our expansion, we have taken our passion for to various countries around the world. Our commitment to excellence and innovation has allowed us to adapt and thrive in diverse global environments. We have expanded our reach and have been privileged to contribute to sustainable development around the world.**

**We believe in the strength of diversity and global collaboration.**

Desde nuestro comienzo hasta nuestra expansión, hemos llevado nuestra pasión por diversos países en todo el mundo. Nuestro compromiso con la excelencia y la innovación nos ha permitido adaptarnos y prosperar en entornos globales diversos. Hemos ampliado nuestro alcance y hemos tenido el privilegio de contribuir al desarrollo sostenible en todo el mundo.

Creemos en la fuerza de la diversidad y la colaboración global.



*Depuis nos débuts jusqu'à notre expansion, nous avons transporté notre passion dans divers pays du monde. Notre engagement envers l'excellence et l'innovation nous a permis de nous adapter et de prospérer dans divers environnements mondiaux. Nous avons élargi notre portée et avons eu le privilège de contribuer au développement durable dans le monde entier.*

*Nous croyons en la force de la diversité et de la collaboration mondiale.*

Dal nostro inizio fino alla nostra espansione, abbiamo portato la nostra passione in vari paesi del mondo. Il nostro impegno per l'eccellenza e l'innovazione ci ha permesso di adattarci e prosperare in diversi ambienti globali. Abbiamo ampliato la nostra portata e abbiamo avuto il privilegio di contribuire allo sviluppo sostenibile in tutto il mondo.

Crediamo nella forza della diversità e della collaborazione globale.



# We are from Barcelona

41°22'57"N 2°10'37"E

---

**We design and manufacture our collections at our facilities in Barcelona after a careful process of material and finish selection, where sustainability is our main focus in all projects. Achieving aesthetic, functional, and sustainable products has been our mission since our inception in 1967. After 58 years and operating in more than 60 countries, we still have a conviction in our DNA to create products considering their recyclability, from the origin of the materials to their longevity.**

Diseñamos y fabricamos nuestras colecciones en las instalaciones de Barcelona después de un cuidadoso proceso de selección de materiales y acabados, en los que primamos la sostenibilidad como eje principal en todos los proyectos. Conseguir productos estéticos, funcionales y sostenibles es nuestro cometido desde nuestros inicios en 1967. Tras 58 años y operando en más de 60 países, seguimos teniendo en nuestro ADN una convicción de crear productos teniendo en cuenta su reciclabilidad, desde el origen de los materiales hasta la longevidad del mismo.



*Nous concevons et fabriquons nos collections dans nos installations à Barcelone après un processus méticuleux de sélection des matériaux et des finitions, où la durabilité est notre principal objectif dans tous les projets. Atteindre des produits esthétiques, fonctionnels et durables est notre mission depuis notre création en 1967. Après 58 ans et en opérant dans plus de 60 pays, nous avons toujours la conviction, inscrite dans notre ADN, de créer des produits en tenant compte de leur recyclabilité, depuis l'origine des matériaux jusqu'à leur longévité.*

Progettiamo e fabbrichiamo le nostre collezioni presso i nostri impianti a Barcellona dopo un accurato processo di selezione dei materiali e delle finiture, dove la sostenibilità è il nostro principale focus in tutti i progetti. Ottenere prodotti estetici, funzionali e sostenibili è stata la nostra missione fin dalla nostra fondazione nel 1967. Dopo 58 anni e operando in più di 60 paesi, abbiamo ancora la convinzione nel nostro DNA di creare prodotti considerando la loro riciclabilità, dall'origine dei materiali alla loro longevità.

# Customize

---

**Since forever, man has made spaces his own. Sizes, finishes, textures, or colors are some of the elements to consider for each space. The black Ford T passed into history. We customize our collections for each of your needs, even creating the special product you need for your project.**

Desde siempre, el hombre ha hecho suyos los espacios. Tamaños, acabados, texturas o colores son algunos de los elementos a tener en cuenta para cada espacio. El Ford T negro, pasó a la historia. Personalizamos nuestras colecciones para cada una de tus necesidades, incluso creamos el producto especial que necesitas para tu proyecto.

---

*Depuis toujours, l'homme s'est approprié les espaces. Tailles, finitions, textures ou couleurs sont quelques-uns des éléments à prendre en compte pour chaque espace. La Ford T noire est passée à l'histoire. Nous personnalisons nos collections pour chacun de vos besoins, créant même le produit spécial dont vous avez besoin pour votre projet.*

Da sempre, l'uomo ha fatto propri gli spazi. Dimensioni, finiture, texture o colori sono alcuni degli elementi da considerare per ogni spazio. La Ford T nera è passata alla storia. Personalizziamo le nostre collezioni per ogni tua esigenza, creando anche il prodotto speciale di cui hai bisogno per il tuo progetto.

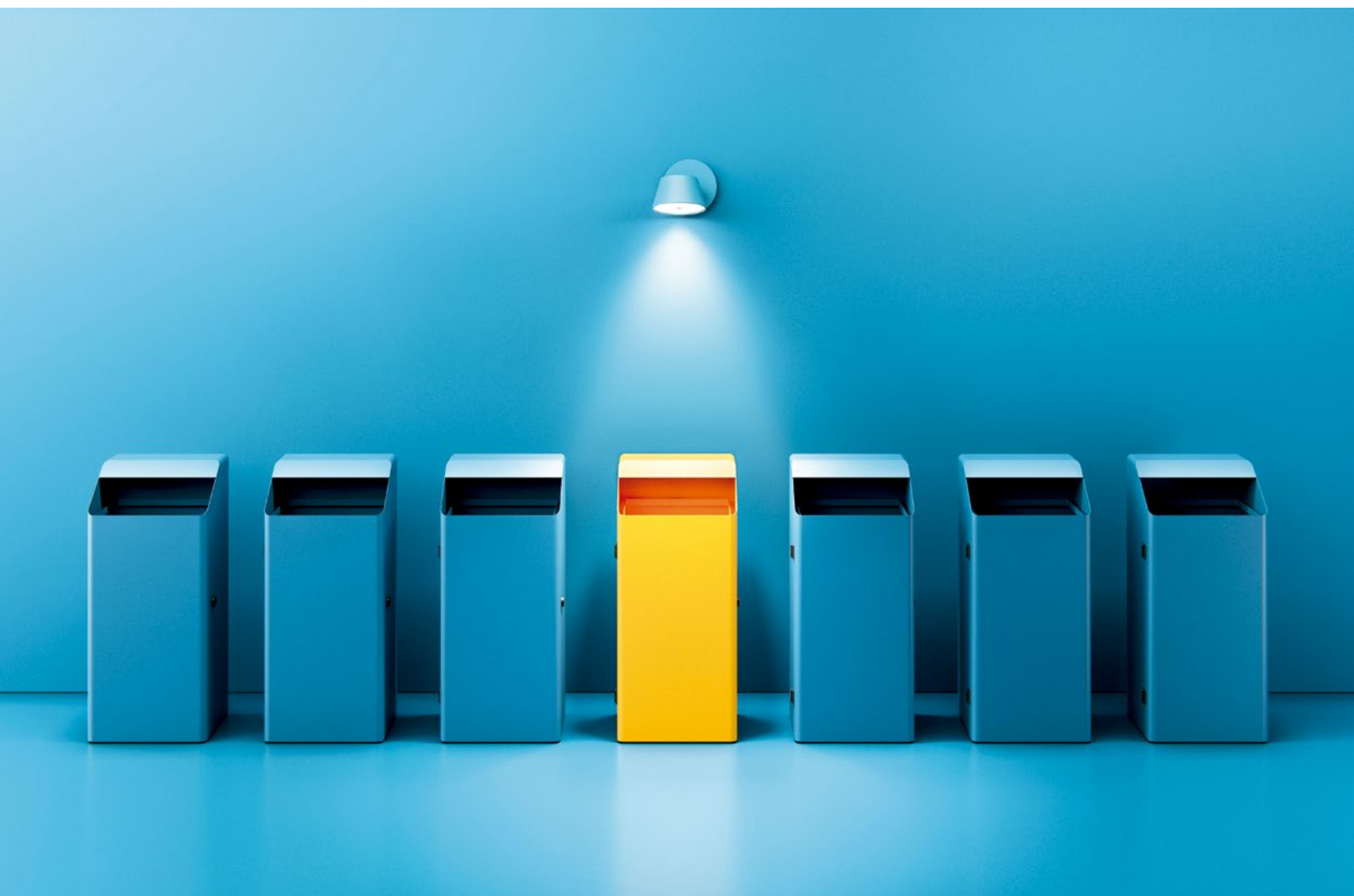

# We are green



ER-0209/2021

**ISO 14001**  
**Environmental**  
**management**



ER-0209/2021

**ISO 9001**  
**Quality**  
**management**



**We generate an excessive amount of waste and one of the ways in which we can help the environment is with our recycling stations and bins to make the separation of waste easier, promote recycling and at the same time, create pieces with an authentic design, adding character and aesthetic integrated into your environment.**

**The planet needs help;  
recycling is no longer optional.**

Generamos una cantidad excesiva de residuos y una de las formas en las que podemos ayudar al medio ambiente es con nuestras estaciones y papeleras de reciclaje para facilitar la separación de residuos, fomentar el reciclaje y al mismo tiempo crear piezas con un diseño auténtico, añadiendo carácter y estética integrados en su entorno.

El planeta necesita ayuda;  
El reciclaje ya no es opcional.

*Nous générons une quantité excessive de déchets et l'une des façons dont nous pouvons aider l'environnement est d'utiliser nos stations de recyclage et nos poubelles pour faciliter le tri des déchets, promouvoir le recyclage et en même temps créer des pièces au design authentique, en ajoutant caractère et esthétique intégrés dans votre environnement.*

*La planète a besoin d'aide ;  
le recyclage n'est plus facultatif.*

Generiamo una quantità eccessiva di rifiuti e uno dei modi in cui possiamo aiutare l'ambiente è con le nostre stazioni di riciclaggio e contenitori per facilitare la separazione dei rifiuti, promuovere il riciclaggio e, allo stesso tempo, creare pezzi dal design autentico, aggiungendo carattere ed estetica integrati in il tuo ambiente.

Il pianeta ha bisogno di aiuto;  
il riciclaggio non è più facoltativo.



# Colors

---

**Develop your own style by personalizing the colours of our products, making them unique and transforming the design and essence of your space.**

Consigue un estilo propio personalizando el color de nuestros productos, convirtiéndolos en únicos y transforma el ambiente y la esencia de tu espacio.

*Développez votre propre style en personnalisant les couleurs de nos produits, en les rendant uniques et en transformant le design et l'essence de votre espace.*

**Sviluppa il tuo stile personalizzando i colori dei nostri prodotti, rendendoli unici e trasformando il design e l'essenza del tuo spazio.**







BL · Ral 9003



CE · Ral 7033



GR · Ral 7015



AN · Ral 7016



MA · Ral 8014



OP · Ral 1036



VF · Ral 6020



VO · Ral 6011



VD · Ral 6000



PE · Ral 5020



AZ · Ral 5009



BD · Ral 3005



RJ · Ral 3020



RS · Ral 2012



NJ · Ral 2017



AM · Ral 1007

---

# Recycling

01

---

---

<b>18</b>	Pictos
<b>20</b>	Caps & holes
<b>22</b>	Bags
<b>24</b>	Davos
<b>32</b>	Nyon
<b>40</b>	Lausanne
<b>48</b>	Vevey
<b>56</b>	Berna
<b>64</b>	Zurich
<b>74</b>	Basilea
<b>82</b>	Zell
<b>90</b>	Interlaken
<b>98</b>	Baden
<b>106</b>	Thun
<b>114</b>	Biel
<b>122</b>	Winterthur
<b>130</b>	Friburg
<b>138</b>	Lugano
<b>146</b>	Laax

# Pictos

REFERENCE

PIC 00B (Black)  
PIC 00W (White)  
PIC 00C (Personalized)

01



**Waste**

Residuos

*Déchet*

Rifiuti

02



**Paper**

Papel

*Papier*

Carta

03



**Glass**

Crystal

*Verres*

Bicchiere

04



**Plastic**

Plástico

*Plastique*

Plastica

05

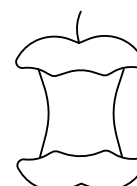

**Organic**

Orgánico

*Biologique*

Biologico

06

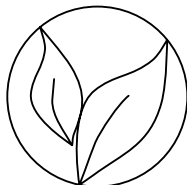

**Organic**

Orgánico

*Biologique*

Biologico

07

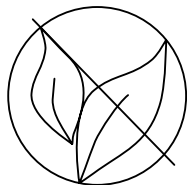

**Inorganic**

Inorgánico

*Inorganique*

Inorganico

08



**Aluminium**

Aluminio

*Aluminium*

Alluminio

09



**Bottles cans**

Latas botellas

*Canettes bouteilles*

Lattine da bottiglie

10

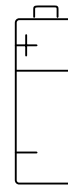

**Batteries**

Pilas

*Piles*

Batterie

11

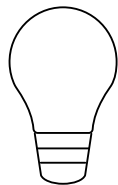

**Led light bulb**

Bombilla led

*Ampoules LED*

Lampadina a led

12

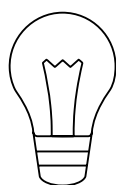

**Light bulb**

Bombilla

*Ampoule*

Lampadina

13

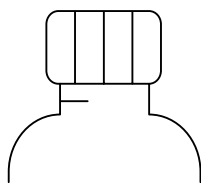

**Bottle cap**

Tapa de botella

*Bouchon de la bouteille*

Tappo della bottiglia

14

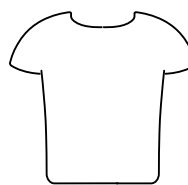

**Textile**

Textil

*Textiles*

Tessile

15

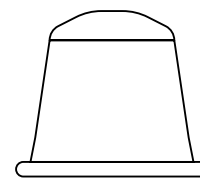

**Coffee capsule**

Cápsula de café

*Capsules de café*

Capsule di caffè

BLACK 

WHITE 

PERSONALIZED 

16

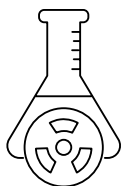

**Toxic**

Tóxicos

*Toxique*

Tossico

17

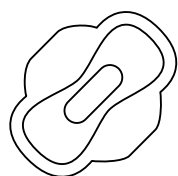

**Feminine hygiene**

Higiene femenina

*Hygiène féminine*

Giene femminile

18

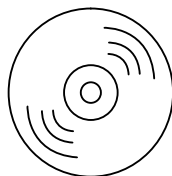

**CD**

CD

*CD*

CD

19

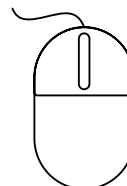

**Electronic device**

Dispositivo electrónico

*Appareil électronique*

Dispositivo elettronico

20

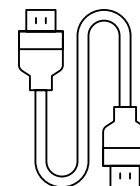

**Cable**

Cable

*Câble*

Cavo

21

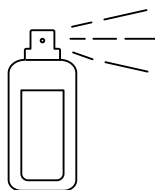

**Spray**

Bote spray

*Aérosol*

Bombola spray

22

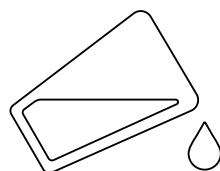

**Liquid**

Líquidos

*Liquides*

Liquidi

23



**Metal**

Metales

*Métal*

Metallo

24



**Oil**

Aceite

*Huile*

Olio

25

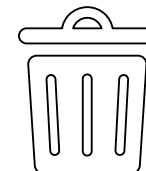

**Waste**

Residuos

*Déchets*

Rifiuti

26

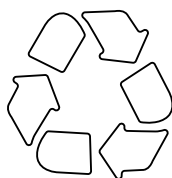

**Recycling**

Reciclaje

*Recyclage*

Riciclaggio

27



**General waste**

Basura general

*Déchets généraux*

Immondizia generale

28

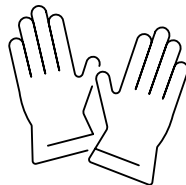

**Gloves**

Guantes

*Gants*

Guanti

29

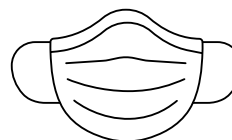

**Face mask**

Mascarilla

*Masque facial*

Maschera per il viso

30

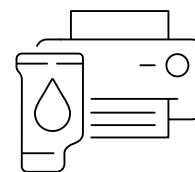

**Toner**

Tóner

*Toners*

Tonici

# Caps & holes

**Choose the design of the trash can lids to your liking according to your needs. From circles to more complex shapes, the design is in your hands.**

Escoge el diseño de las tapas de las papeleras a tu gusto según tus necesidades. Desde círculos hasta formas más complejas, el diseño está en tus manos.

*Choisissez le design des couvercles de poubelle à votre goût en fonction de vos besoins. Des cercles aux formes plus complexes, le design est entre vos mains.*

Scegli il design dei coperchi dei bidoni della spazzatura a tuo piacimento in base alle tue esigenze. Dai cerchi alle forme più complesse, il design è nelle tue mani.

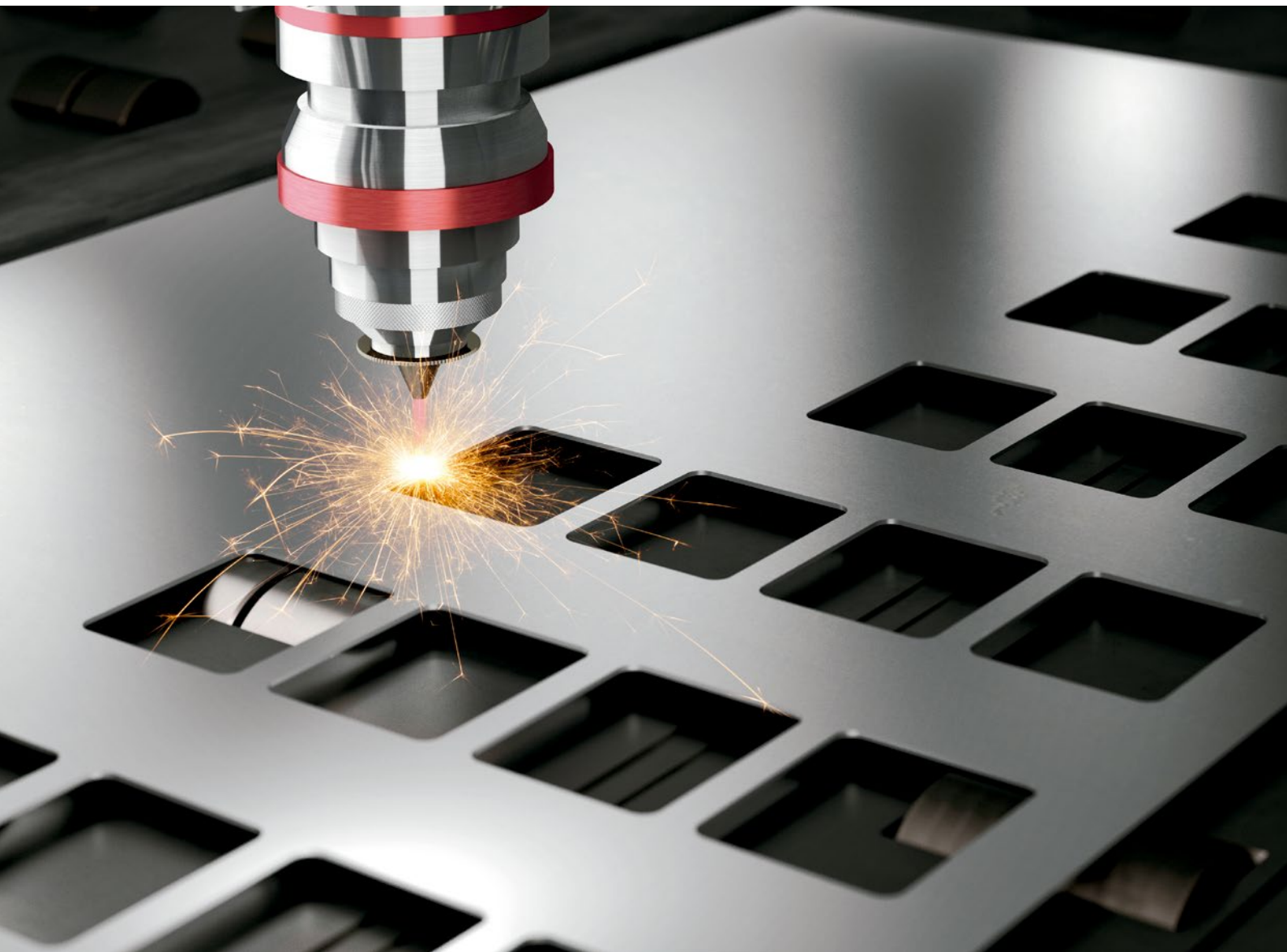

Customize options

REFERENCE



HEIGHT & WIDTH

**HOL/ CR**

ø 12 cm  
ø 4,7 in.

**HOL/ PA**

5 x 25 cm  
1,9 x 9,8 in.

**HOL/ CF**

5 x 4 cm  
1,9 x 1,5 in.

**HOL/ LB**

10 x 15 cm  
3,9 x 5,9 in.

**HOL/ SQ**

11 x 11 cm  
4,3 x 4,3 in.

**HOL/ BT**

11 x 4 cm  
4,3 x 1,5 in.

**HOL/ BC**

6 x 2,5 cm  
2,3 x 1 in.

**HOL/ 00**

XX cm  
XX in.

**HOL/ CR**

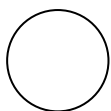

**Circle**

Círculo  
Cercle  
Cerchio

**HOL/ SQ**

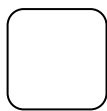

**Square**

Cuadrado  
Carré  
Piazza

**HOL/ PA**

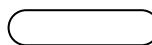

**Paper**

Papel  
Papier  
Carta

**HOL/ BT**



**Batteries**

Pilas  
Piles  
Batterie

**HOL/ CF**



**Coffee capsule**

Cápsula de café  
Capsule de café  
Girare capsula del caffè

**HOL/ BC**



**Bottle cap**

Tapa de botella  
Bouchon de la bouteille  
Tappo di bottiglia

**HOL/ LB**



**Light bulb**

Bombilla  
Ampoule  
Lampadina

**HOL/ 00**



**Others**

Otros  
Autres  
Altri

# Bags

---

**We offer different sizes of bags for your needs. Our bags are available in various sizes and formats so you can choose the one that best fits your recycling bin.**









Ofrecemos diferentes medidas de bolsas para tus necesidades. Nuestras bolsas están disponibles en diferentes tamaños, formatos, para que puedas elegir la que mejor se adapte según tu contenedor de reciclaje.

*Nous proposons différentes tailles de sacs pour vos besoins. Nos sacs sont disponibles en différentes tailles et formats afin que vous puissiez choisir celui qui s'adapte le mieux à votre bac de recyclage.*

Offriamo diverse misure di sacchetti per le tue esigenze. I nostri sacchetti sono disponibili in varie dimensioni e formati, così puoi scegliere quello che si adatta meglio al tuo contenitore per il riciclaggio.





PRODUCT	REFERENCE	SIZE	RECYCLING COLORS
	<b>BAG 01</b>	54 x 60 cm 21,3 x 23,6 in.  25 uds.  70 galga - 70 gauge	<ul style="list-style-type: none"> <li> GR · GREY</li> <li> NG · BLACK</li> <li> BL · WHITE</li> <li> AZ · BLUE</li> <li> VD · GREEN</li> <li> AM · YELLOW</li> <li> RJ · RED</li> </ul>
	<b>BAG 02</b>	85 x 105 cm 33,4 x 41,3 in.  10 uds.  150 galga - 150 gauge	



# Davos

by Nahtrang

**The ideal "point" for recycling ... place one, two, three or even four bins and your environment will be ready to recycle. Made of sheet metal with flip top lid. It is very resistant and has a bag ring for easy removal.**

El "punto" de reciclaje ideal... coloca uno, dos, tres, o hasta cuatro "Points" y tu espacio ya estará listo para reciclar. Fabricada en chapa metálica cilindrada y tapa abatible superior. Es muy resistente y dispone de aro porta bolsa para facilitar su uso.

*Le "point" de recyclage idéal... placez un, deux, trois ou même quatre "Points" et votre espace sera prêt à recycler. Fabriquée en tôle et muni d'un couvercle rabattable. Il est très résistant et possède un anneau porte sac pour faciliter son utilisation.*

Il "punto" di riciclaggio ideale... posiziona uno, due, tre o anche quattro "Punti" e il tuo spazio sarà pronto per il riciclo. Realizzato in lamiera e dotato di coperchio incernierato. È molto resistente e dispone di un anello per borsa per facilitarne l'utilizzo.





RECYCLING



PAPER



WASTE



BOTTLES  
CANS



ORGANIC





# More about Davos

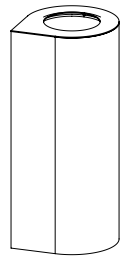

SCALE 1:20 (cm)

DESIGNER  
Nahtrang

YEAR  
2018

LINE SKETCH

PRODUCT

REFERENCE

SIZE



**DVS 01**

30 x 30 x 73 cm — 52 L  
11,8 x 11,8 x 28,7 in. — 13,7 gal.



COMPLETE RECYCLING POINT FOR A TYPE OF WASTE

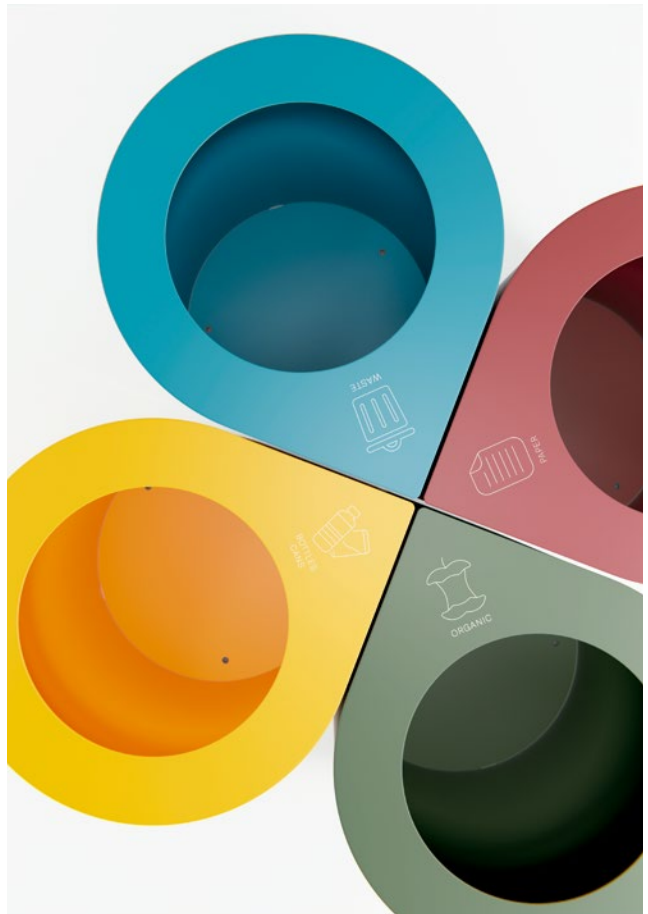
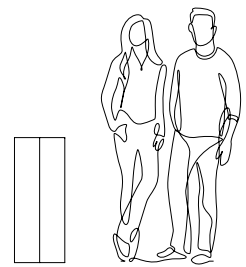

OPENING DETAIL OF LID AND RING TO HOLD WASTE BAG

# Davos

by Nahtrang

← VIEW PRODUCT PAGES

24







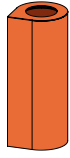









CHARACTERISTICS	CARACTERÍSTICAS	CARACTÉRISTIQUES	CARATTERISTICHE
Bin made of 1.2 mm sheet metal. Tilting lid attached to the body of the bin using two hinges. The ring to hold the bag hangs from the lid. The base is welded to the body of the bin unifying both elements seamlessly. The base includes holes for drainage. Rubber blocks attached to base to protect the surface where it is located. Vinyl residue indicator icon.	Papelera fabricada en chapa de hierro de 1,2 mm. Tapa basculante sujeta al cuerpo de la papelera con dos bisagras. El aro para sujetar la bolsa cuelga de la tapa. Unión de la base con el cuerpo de la papelera mediante soldadura. La base incluye agujeros para el desagüe. Base con tacos de goma para proteger la superficie donde se ubique. Icono indicador de residuo en vinilo.	<i>Corbeille fabriquée en tôle de 1,2 mm d'épaisseur. Couvercle inclinable fixé au corps de la corbeille avec deux charnières. L'anneau pour tenir le sac est suspendu au couvercle. Union de la base et du corps de la corbeille soudé. La base comprend des trous pour le drainage. Base munie de gommages de caoutchouc pour protéger la surface où elle se trouve. Icône d'indicateur de résidus en vinyle.</i>	<i>Contentitore in lamiera Ferro da 1,2 mm. Coperchio basculante fissato al corpo del bidone con due cerniere. Il anello per tenere la borsa pende da il coperchio. Unione de la base con il corpo del contenitore mediante saldatura. La base include fori per il drenaggio. Base con borchie in gomma per proteggere il superficie dove si trova. Icona indicatore di residui di vinile.</i>
REF	↕↔		
 <b>DVS 01</b>	30 x 30 x 73 cm — 52 L 11,8 x 11,8 x 28,7 in. — 13,7 gal	14 kg 30,9 lb.	

ENVIRONMENTAL IMPACT				FIRE RESISTANCE	RÉSISTANCE AU FEU		
				RESISTENCIA AL FUEGO	RESISTENZA AL FUOCO		
Materials may be easily disassembled to be recycled.	Materiales fácilmente segregables para su posterior reciclado.	<i>Matériaux facilement démontables pour leurs recyclages.</i>	<i>Materiali facilmente separabile per un successivo riciclaggio.</i>	UNE-EN 13501-1	A1-s1, d0		
WARRANTY	GARANTIA	GARANTIE	GARANZIA	PACKAGING	EMBALAJE	EMBALLAGE	IMBALLAGGIO
Two (2) year limited warranty. Does not cover: incorrect use, bad handling or deliberate damage.	Garantía de dos (2) años limitada. No cubre: mal uso, manipulación o daños intencionados.	<i>Garantie deux (2) ans. À l'exception: mauvaise utilisation, manipulation, dommages intentionnés.</i>	<i>Due (2) anni di garanzie limitati. Non copre: uso improprio, manipolazione o danno intenzionale.</i>	Cardboard box with plastic bag for product protection. One package.	Caja de cartón con bolsa de plástico para protección. Un paquete.	<i>Boîte en carton avec sac plastique pour la protection. Un paquet.</i>	<i>Scatola di cartone con sacchetto di plastica per protezione. Un pacco.</i>







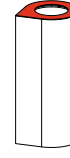

BRAND COLORS

-  BL · Ral 9003
-  CE · Ral 7033
-  GR · Ral 7015
-  AN · Ral 7016
-  MA · Ral 8014
-  OP · Ral 1036
-  VF · Ral 6020
-  VO · Ral 6011
-  VD · Ral 6000
-  PE · Ral 5020
-  AZ · Ral 5009
-  BD · Ral 3005
-  RJ · Ral 3020
-  RS · Ral 2012
-  AM · Ral 1007
-  NJ · Ral 2017



RECYCLING COLORS

-  BLR · RAL 9003 + 3027
-  BLA · RAL 9003 + 1023
-  BLV · RAL 9003 + 6016
-  BLZ · RAL 9003 + 5012
-  BLM · RAL 9003 + 8025

Bajo pedido puede hacerse tratamiento de cataforesis para uso a la intemperie

Upon request, cataphoresis treatment can be made for outdoor use.

Sur demande, un traitement par cataphorèse peut être réalisé pour une utilisation en extérieur.





Su richiesta è possibile effettuare il trattamento di cataforesi per esterni.

CUSTOMIZE OPTIONS

OPCIONES PERSONALIZADAS

PERSONNALISER LES OPTIONS

OPZIONI DI PERSONALIZZAZIONE

-  RAL COLOR
-  TRASH BAG
-  PICTOGRAMS
-  HOLE ON LID
-  HEIGHT & WIDTH











STANDARD HOLE

-  HOL / CR      ø 12 cm  
ø 4,7 in.

TRASH BAG

-  BAG 01      54 x 60 cm  
21,3 x 23,6 in.

LABELS

- |  |   |
|--|---|
| Thickness  1,2 mm       | Acoustic  Doesn't absorb sound           |
| Material  Iron          | Fire resistance  UNE-EN 13501-1 A1-51,d0 |
| Finish  Painting        | Optimal Space  Indoor                    |
| Conductivity  100%      | Cleaning  Water & Drying                 |
| Volume  52 L - 13,7 gal | Weight  14 kg / 30,9 lb. unit            |



# Nyon

---

by Roger Vancells

**There are bins and then there's Nyon. Whose presence and character do not go unnoticed. In two sizes, with three designs and colours, and now, with a version of treated cedar wood for outdoors allowing you to integrate it perfectly into any landscape.**

Hay papeleras y luego está Nyon. Su presencia y carácter la hacen no pasar inadvertida. En dos tamaños, con tres diseños y colores, y ahora, con una versión en madera de cedro tratada para exteriores, que le permite integrarse a la perfección en cualquier paisaje.

*Il existe des corbeilles et puis il y a Nyon. Sa présence et son caractère ne la font pas passer inaperçue. En deux tailles, avec trois motifs et couleurs, et maintenant, avec une version en bois de cèdre traité pour l'extérieur, qui lui permet de s'intégrer parfaitement dans n'importe quel paysage.*

Ci sono i bidoni e poi c'è Nyon. La sua presenza e il suo carattere non passano inosservati. In due misure, con tre disegni e colori, e ora, con una versione in legno di cedro trattato per esterni, che gli permette di essere integrato nel perfezione in ogni paesaggio.









# More about Nyon

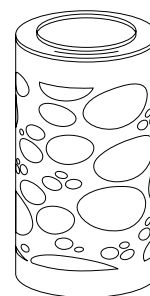

SCALE 1:20 (cm)

DESIGNER

Roger Vancells

YEAR

2015/2018

LINE SKETCH

PRODUCT

REFERENCE

SIZE



**NYO 10 / 10C**  
**NYO 12 / 12C**  
**NYO 18 / 18C**

Ø 44 x 84 cm – 80 L  
Ø 17,2 x 32,8 in. – 21 gal.  
C: Ashtray option



**NYO 20**  
**NYO 22**

Ø 23 x 44 cm – 12 L  
Ø 9 x 17,9 in. – 3,2 gal.

PRODUCT

REFERENCE

SIZE



**NYO 50**  
**NYO 52**

Ø 23 x 44 cm  
Ø 9 x 17,3 in.



**NYO 60**  
**NYO 62**

Ø 17 x 87,8 cm  
Ø 6,7 x 34,6 in.

TEXTURE



0 - ORGANIC



8 - WOOD



2 - LINEAR



WOODEN NYON WASTE BIN WITH ASHTRAY - NYO 18C

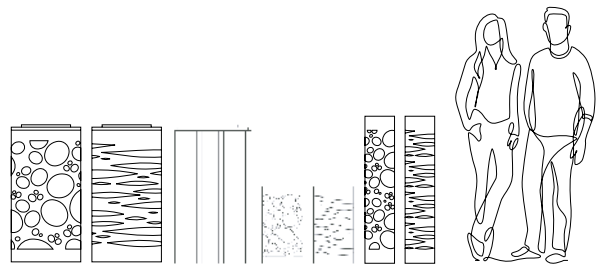

NYON CLASSIC OXI TOP OPENING WITH ASHTRAY — NYO 14C



NYON LINEAR RED HINGE DETAIL — NYO 12





# Nyon

by Roger Vancells

← VIEW PRODUCT PAGES

32

CHARACTERISTICS	CARACTERÍSTICAS	CARACTÉRISTIQUES	CARATTERISTICHE
Bin consisting of two cylinders made of 1.5 mm sheet metal and a 4 mm lid. The outer cylinder is decorative and can be replaced by wooden slats. The inner cylinder serves to hold the bag. The base and body of the bin unified by welding. Base supplied with rubber blocks to protect the surface where it is located.	Papelera compuesta de dos cilindros fabricados en chapa de hierro de 1,5 mm y una tapa de hierro de 4 mm. El cilindro exterior es decorativo y puede ser substituido por lamas de madera. El cilindro interior sirve para sujetar la bolsa. Unión de la base con el cuerpo de la papelera mediante soldadura. Base con tacos de goma para proteger la superficie donde se ubique.	Corbeille composée de deux cylindres en tôle d'1,5 mm d'épaisseur et d'un couvercle en fer de 4 mm. Le cylindre extérieur est décoratif et peut être remplacé par des lattes de bois. Le cylindre intérieur sert à tenir le sac. Union de la base et du corps de la corbeille soudé. Base avec des gommages de caoutchouc pour protéger la surface où elle se trouve.	Contenitore composto da due cilindri in lamiera ferro da 1,5 mm e un coperchio di ferro da 4mm. Il cilindro esterno è decorativo e può essere sostituito da lamelle di legno. Il cilindro interno serve per tenere la borsa. Unione del base con corpo contenitore mediante saldatura. Base con borchie in gomma per proteggere il superficie dove si trova.

	REF	↕↔	📏		REF	↕↔	📏
	<b>NYO 10 / 10C</b> <b>NYO 12 / 12C</b>	Ø44 x 84 cm — 80 L Ø17,2 x 32,8 in. — 21 gal.	20 kg 44,1 lb.		<b>NYO 50</b> <b>NYO 52</b>	Ø23 x 44 cm Ø9 x 17,3 in. 5,5 kg 12,1 lb.	5,5 kg 12,1 lb.
	<b>NYO 18 / 18C</b>	Ø44 x 84 cm — 80 L Ø17,2 x 32,8 in. — 21 gal.	27,9 kg 61,5 lb.		<b>NYO 60</b> <b>NYO 62</b>	Ø17 x 87,8 cm Ø6,7 x 34,6 in. 6 kg 13,2 lb.	6 kg 13,2 lb.
	<b>NYO 20</b> <b>NYO 22</b>	Ø23 x 44 cm — 12 L Ø9 x 17,9 in. — 3,2 gal.	5,5 kg 12,1 lb.				

















ENVIRONMENTAL IMPACT				FIRE RESISTANCE	RÉSISTANCE AU FEU
				RESISTENCIA AL FUEGO	RESISTENZA AL FUOCO
Materials may be easily disassembled to be recycled.	Materiales fácilmente segregables para su posterior reciclado.	<i>Matériaux facilement démontables pour leurs recyclages.</i>	<i>Materiali facilmente separabile per un successivo riciclaggio.</i>	UNE-EN 13501-1	A1-s1, d0

WARRANTY	GARANTIA	GARANTIE	GARANZIA	PACKAGING	EMBALAJE	EMBALLAGE	IMBALLAGGIO
Two (2) year limited warranty. Does not cover: incorrect use, bad handling or deliberate damage.	Garantía de dos (2) años limitada. No cubre: mal uso, manipulación o daños intencionados.	<i>Garantie deux (2) ans. À l'exception: mauvaise utilisation, manipulation, dommages intentionnés.</i>	<i>Due (2) anni di garanzie limitati. Non copre: uso improprio, manipolazione o danno intenzionale.</i>	Cardboard box with plastic bag for product protection. One package.	Caja de cartón con bolsa de plástico para protección. Un paquete.	<i>Boîte en carton avec sac plastique pour la protection. Un paquet.</i>	<i>Scatola di cartone con sacchetto di plastica per protezione. Un pacco.</i>





BRAND COLORS

-  BL · Ral 9003
-  CE · Ral 7033
-  GR · Ral 7015
-  AN · Ral 7016
-  MA · Ral 8014
-  OP · Ral 1036
-  VF · Ral 6020
-  VO · Ral 6011
-  VD · Ral 6000
-  PE · Ral 5020
-  AZ · Ral 5009
-  BD · Ral 3005
-  RJ · Ral 3020
-  RS · Ral 2012
-  AM · Ral 1007
-  NJ · Ral 2017

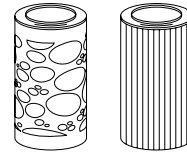

OTHER FINISHES

-  OXI
-  WOOD



STANDARD COLOUR INTERIOR BIN

-  AN · Ral 7016

CUSTOMIZE OPTIONS  
OPCIONES PERSONALIZADAS

PERSONNALISER LES OPTIONS  
OPZIONI DI PERSONALIZZAZIONE

-  RAL COLOR
-  TRASH BAG
-  PATTERN
-  HEIGHT & WIDTH











STANDARD HOLE

-  HOL / CR      ø 30 cm  
ø 11,8 in.

TRASH BAG

-  BAG 01      54 x 60 cm  
21,3 x 23,6 in.

LABELS

- |   |   |
|---|---|
| Thickness  1,5 mm                | Acoustic  Doesn't absorb sound           |
| Material  Iron                   | Fire resistance  UNE-EN 13501-1 A1-51,d0 |
| Finish  Painting                 | Optimal Space  Indoor / Outdoor          |
| Conductivity  100% *iron version | Cleaning  Water & Drying                 |
| Volume  See page 38              | Weight  See page 38                      |



# Lausanne

by Toni Arola

**An ideal bin for both indoor and outdoor use. Resists everything thanks to its structure made from sheet metal with its base and head in cast aluminum. In addition to the steel version, it is now in deployé, and you can choose with or without an ashtray.**

*Une poubelle idéale pour l'intérieur comme pour l'extérieur. Résiste à tout, grâce à sa structure en tôle d'acier et à sa base et sa tête en fonte d'aluminium. En plus d'une version en acier, il est maintenant disponible en métal déployé, vous pouvez la choisir avec ou sans cendrier.*

Una papelera ideal tanto para interiores como para exteriores. Resiste a todo gracias a su estructura fabricada en plancha de acero y su base y cabezal en fundición de aluminio. Además de la versión acero, ahora está en deployé, y puedes elegirla con o sin cenicero.

Un bidone ideale sia per gli interni come per gli esterni. Resiste a tutto grazie alla sua struttura fatta di lamine di acciaio e la sua base e testa in fusione di alluminio. La versione Plus in acciaio, ora è attivo e puoi sceglierlo con o senza posacenere.









# More about Lausanne

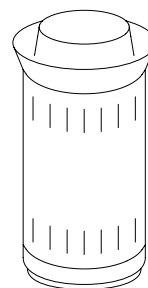

SCALE 1:20 (cm)

DESIGNER

Toni Arola

YEAR

1990 / 2018

LINE SKETCH

PRODUCT

REFERENCE

SIZE



LSN 01  
LSN 02

Ø45 x 80 cm – 120 L  
Ø17,7 x 33,1 in. – 26,4 gal



LSN 01D  
LSN 02D

Ø45 x 80 cm – 120 L  
Ø17,7 x 33,1 in. – 26,4 gal

D: Déployé version



VIEW LAUSANNE DÉPLOYÉ ANTHRACITE AND LAUSANNE INOX WITH ASHTRAY – LSN 01D 7016 + LSN 02 INOX

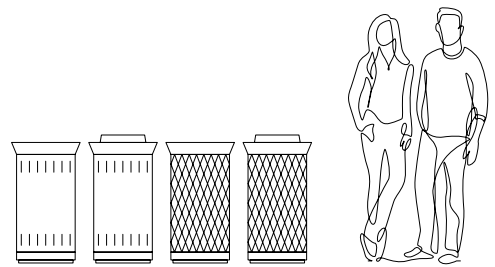

OPENING AND RING DETAIL — LSN 02D 7016





LAUSANNE DEPLOYÉ DETAIL — LSN 02D

# Lausanne

by Toni Arola

← VIEW PRODUCT PAGES

40

CHARACTERISTICS	CARACTERÍSTICAS	CARACTÉRISTIQUES	CARATTERISTICHE
Base and top made of cast aluminum and body in 1.5 mm steel or deployé. Unified using rivets. Depending on which model, a piece of repulsed aluminum is placed to act as a wastepaper basket or ashtray-bin. Between the embellisher and the lid a ring is placed to hold the bag.	Base y cabezal de fundición de aluminio y cuerpo en plancha de acero de 1,5 mm o chapa de hierro deployé. Unión de las 3 partes mediante remaches. Según modelo, se coloca una pieza de aluminio repulsado para hacer la función de papelerera o cenicero-papelerera. Entre el embellecedor y el cabezal se sitúa un aro para sujetar la bolsa.	<i>Base et partie supérieure en fonte d'aluminium et corps en tôle d'acier de 1,5 mm d'épaisseur ou en métal déployé. Union des 3 pièces à l'aide de rivets. Selon le modèle, un morceau d'aluminium repoussé est placé pour servir de corbeille à papier ou de cendrier. Un anneau est placé entre l'embellisseur et la partie supérieure pour maintenir le sac.</i>	<i>Testa e base in colata di alluminio e corpo in lamiera di acciaio o lamiera di ferro deployé da 1,5 mm. Unione delle 3 parti per rivetti. A seconda del modello, viene posizionato un pezzo di alluminio respinto per rendere la funzione di contenitore o posacenere-contenitore. Tra le coperture di protezione viene posizionato un anello per tenere la borsa.</i>
REF	↕↔		
 <b>LSN 01</b> <b>LSN 11 IN</b>  <b>LSN 02</b> <b>LSN 12 IN</b>	Ø45 x 80 cm – 120 L Ø17,7 x 33,1 in. – 26,4 gal.	21 kg 46,3 lb.	
 <b>LSN 01D</b>  <b>LSN 02D</b>	Ø45 x 80 cm – 120 L Ø17,7 x 33,1 in. – 26,4 gal.	14 kg 30,9 lb.	D: Deployé version







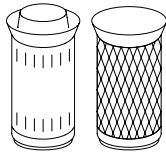









ENVIRONMENTAL IMPACT				FIRE RESISTANCE	RÉSISTANCE AU FEU
				RESISTENCIA AL FUEGO	RESISTENZA AL FUOCO
Materials may be easily disassembled to be recycled.	Materiales fácilmente segregables para su posterior reciclado.	<i>Matériaux facilement démontables pour leurs recyclages.</i>	<i>Materiali facilmente separabile per un successivo riciclaggio.</i>	UNE-EN 13501-1	A1-s1, d0

WARRANTY	GARANTIA	GARANTIE	GARANZIA	PACKAGING	EMBALAJE	EMBALLAGE	IMBALLAGGIO
Two (2) year limited warranty. Does not cover: incorrect use, bad handling or deliberate damage.	Garantía de dos (2) años limitada. No cubre: mal uso, manipulación o daños intencionados.	<i>Garantie deux (2) ans. À l'exception: mauvaise utilisation, manipulation, dommages intentionnés.</i>	<i>Due (2) anni di garanzie limitati. Non copre: uso improprio, manipolazione o danno intenzionale.</i>	Cardboard box with plastic bag for product protection. One package.	Caja de cartón con bolsa de plástico para protección. Un paquete.	<i>Boite en carton avec sac plastique pour la protection. Un paquet.</i>	<i>Scatola di cartone con sacchetto di plastica per protezione. Un pacco.</i>







BRAND COLORS

 BL · Ral 9003	 VD · Ral 6000
 CE · Ral 7033	 PE · Ral 5020
 GR · Ral 7015	 AZ · Ral 5009
 AN · Ral 7016	 BD · Ral 3005
 MA · Ral 8014	 RJ · Ral 3020
 OP · Ral 1036	 RS · Ral 2012
 VF · Ral 6020	 AM · Ral 1007
 VO · Ral 6011	 NJ · Ral 2017

OTHER FINISHES

 INOX
 D - RAL 7016
 D - RAL 9006



Solo personalizable el cuerpo metálico.  
 Only the metal body is customizable.  
 Seul le corps en métal est personnalisable.  
 Solo il corpo in metallo è personalizzabile.

CUSTOMIZE OPTIONS

OPCIONES PERSONALIZADAS

PERSONNALISER LES OPTIONS











OPZIONI DI PERSONALIZZAZIONE

 RAL COLOR	 TRASH BAG
 PICTOGRAM	

TRASH BAG

 BAG 02	85 x 105 cm 21,3 x 23,6 in.
---	--------------------------------

LABELS

Thickness  1,5 mm	Acoustic  Doesn't absorb sound
Material  Iron + Aluminium	Fire resistance  UNE-EN 13501-1 A1-51,d0
Finish  Painted + Anodised	Optimal Space  Indoor
Conductivity  100% *iron	Cleaning  Water & Drying
Volume  See page 46	Weight  See page 46



# Vevey

by Baumgartner

**A minimalist recycling container, which seeks to break the monotony with its asymmetric geometry, commanding your attention from the first glance. In addition, it travels flat packed for very easy assembly.**

Un contenedor de reciclaje minimalista, que busca romper con la monotonía con su geometría asimétrica, así es cómo llamará tu atención desde el primer golpe de vista. Además, viaja desmontada y es de muy fácil montaje.

*Un conteneur de recyclage minimaliste, qui cherche à rompre la monotonie avec sa géométrie asymétrique, voilà comment il attirera votre attention dès le premier regard. En outre, il voyage démonté et est très facile à assembler.*

Un cestino per il riciclaggio minimalista, sta cercando di rompere la monotonia con la sua geometria assimetrica, ecco come attirerà la tua attenzione già dal primo sguardo. Inoltre, viaggia smontato ed è molto facile da montare.









# More about Vevey

DESIGNER

by Baumgartner

YEAR

2018

LINE SKETCH

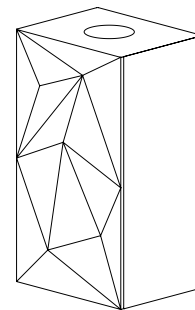

SCALE 1:20 (cm)

PRODUCT

REFERENCE

SIZE



**VVY 01**

41 x 34 x 73 cm – 86 L  
16,1 x 13,4 x 28,7 in. – 22,7 gal



INTERIOR STRUCTURE DETAIL



EASY TO OPEN LID

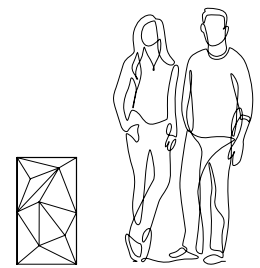

SIMPLE MOUNTING SYSTEM



IDEAL TO CREATE A VISUALLY ATTRACTIVE RECYCLING POINT

CHARACTERISTICS	CARACTERÍSTICAS	CARACTÉRISTIQUES	CARATTERISTICHE
Bin made of 1.2 mm sheet metal with two sides (front and back) in thermoformed high impact polystyrene 3 mm thick. It is shipped disassembled. Simple assembly with 8 butterfly screws. Removable lid. Internal ring to hold the bag in 3 mm sheet metal. Base supplied with rubber blocks to protect the surface where it is located. Vinyl residue indicator icon.	Papelera fabricada en chapa de hierro de 1,2 mm con dos caras (frontal y trasera) en poliestireno de alto impacto termoconformado de 3 mm de grosor. Se envía desmontada. Ensamblaje sencillo mediante 8 tornillos mariposa. Tapa extraíble. Aro interior para sujetar la bolsa en chapa de hierro de 3 mm de grosor. Base con tacos de goma para proteger la superficie donde se ubique. Icono indicador de residuo en vinilo.	<i>Corbeille fabriquée en tôle d'acier de 1,2 mm d'épaisseur avec deux côtés (avant et arrière) en polystyrène thermoformé résistant aux chocs, épaisseur 3 mm. Il est expédié démonté. Assemblage simple avec 8 vis papillon. Couvercle amovible. Anneau interne pour tenir le sac en tôle de 3 mm d'épaisseur. Base avec des gommes de caoutchouc pour protéger la surface où elle se trouve. Icône d'indicateur de résidus en vinyle.</i>	<i>Contenitore in lamiera Ferro a doppia faccia da 1,2 mm (frontale e retro) in polistirolo termoformato ad alto impatto 3 mm di spessore. Inviato smontato. Montaggio semplice utilizzando 8 viti a testa zigrinata. Coperchio rimovibile. Anello interno per fissare la borsa in lamiera di ferro 3 mm di spessore. Base con borchie in gomma per proteggere il superficie dove si trova. Icona indicatore di residui di vinile.</i>

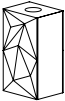
REF	↕↔	📏
 <b>VVY 01</b>	41 x 34 x 73 cm — 86 L 16,1 x 13,4 x 28,7 in. — 22,7 gal	10 kg 22 lb.







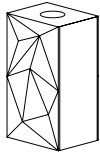









ENVIRONMENTAL IMPACT				FIRE RESISTANCE	RÉSISTANCE AU FEU
				RESISTENCIA AL FUEGO	RESISTENZA AL FUOCO
Materials may be easily disassembled to be recycled.	Materiales fácilmente segregables para su posterior reciclado.	<i>Matériaux facilement démontables pour leurs recyclages.</i>	<i>Materiali facilmente separabile per un successivo riciclaggio.</i>	UNE-EN 13501-1	A1-s1, d0

WARRANTY	GARANTIA	GARANTIE	GARANZIA	PACKAGING	EMBALAJE	EMBALLAGE	IMBALLAGGIO
Two (2) year limited warranty. Does not cover: incorrect use, bad handling or deliberate damage.	Garantía de dos (2) años limitada. No cubre: mal uso, manipulación o daños intencionados.	<i>Garantie deux (2) ans. À l'exception: mauvaise utilisation, manipulation, dommages intentionnés.</i>	<i>Due (2) anni di garanzie limitati. Non copre: uso improprio, manipolazione o danno intenzionale.</i>	Cardboard box with plastic bag for product protection. One package.	Caja de cartón con bolsa de plástico para protección. Un paquete.	<i>Boîte en carton avec sac plastique pour la protection. Un paquet.</i>	<i>Scatola di cartone con sacchetto di plastica per protezione. Un pacco.</i>





BRAND COLORS

 BL · Ral 9003	 VD · Ral 6000
 CE · Ral 7033	 PE · Ral 5020
 GR · Ral 7015	 AZ · Ral 5009
 AN · Ral 7016	 BD · Ral 3005
 MA · Ral 8014	 RJ · Ral 3020
 OP · Ral 1036	 RS · Ral 2012
 VF · Ral 6020	 AM · Ral 1007
 VO · Ral 6011	 NJ · Ral 2017

VINYL COLOURS

 BLUE
 GREEN
 YELLOW
 GREY
 BROWN
 RED

CUSTOMIZE OPTIONS

OPCIONES PERSONALIZADAS

PERSONNALISER LES OPTIONS

OPZIONI DI PERSONALIZZAZIONE



RAL COLOR



TRASH BAG

STANDARD HOLE



HOL / CR

ø 14 cm  
ø 5,5 in.











TRASH BAG



BAG 01

54 x 60 cm  
21,3 x 23,6 in.

LABELS

Thickness  1,5 mm	Acoustic  Doesn't absorb sound
Material  Iron + Polystyrene	Fire resistance  UNE-EN 13501-1 A1-51,d0
Finish  Painting	Optimal Space  Indoor
Conductivity  100% *iron	Cleaning  Water & Drying
Volume  86 L / 22,7 gal	Weight  10 kg / 22 lb. unit



# Berna

by Stone Designs

**Columns that transform, thanks to their geometry, into a stylish and harmonious recycling set with a large capacity, ideal for contract spaces and offices. The inclined flip lid prevents waste from being deposited and odors from escaping. Choose the size between two and the waste type you need.**

*Colonnes qui se transforment, grâce à leur géométrie, en un ensemble de recyclage stylisé et harmonieux de grande capacité, idéal pour les espaces contractuels et les bureaux. Le couvercle basculant incliné empêche les déchets de s'accumuler et les odeurs de se dégager. Choisissez la taille entre deux et le type de déchet dont vous avez besoin.*

Columnas que se convierten, gracias a su geometria, en un conjunto de reciclaje estilizado y armónico de gran capacidad, ideal para espacios contract y oficinas. La tapa abatible inclinada evita que se depositen residuos y que salgan los olores. Elige el tamaño entre dos y el residuo que necesites.

**Colonne che si trasformano, grazie alla loro geometria, in un set di riciclaggio stilizzato e armonioso di grande capacità, ideale per spazi contrattuali e uffici. Il coperchio inclinato evita che i rifiuti vengano depositati e che gli odori escano. Scegli la dimensione tra due e il tipo di rifiuto di cui hai bisogno.**







INORGANIC

PAPER

ORGANIC



# More about Berna

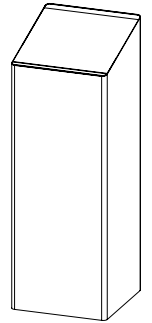

SCALE 1:20 (cm)

DESIGNER

Stone Designs

YEAR

2014

LINE SKETCH

PRODUCT

REFERENCE

SIZE



**BER 02 T**

25 x 25 x 70 cm — 39,4 L  
9,8 x 9,8 x 27,6 in. — 10,5 gal.



**BER 03 T**

35 x 35 x 100 cm — 100 L  
13,8 x 13,8 x 39,4 in. — 26,4 gal.



LID DETAIL - BER 03 T



BAG RING DETAIL

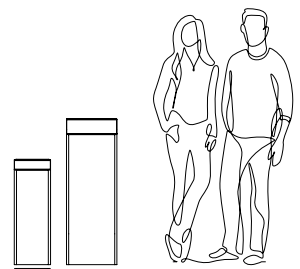

BAG RING DETAIL



BERNA FAMILY



# Berna

by Stone Designs

← VIEW PRODUCT PAGES

56

CHARACTERISTICS	CARACTERÍSTICAS	CARACTÉRISTIQUES	CARATTERISTICHE
Recycling bin made of 1.5 mm sheet metal. The hinged lid is attached to the body with 2 non visible screws. Hoop ring to hold the rubbish bag included inside the bin. The base body unified seamlessly by welding. Base fitted with rubber blocks to protect the surface where it is located. Vinyl residue indicator icon.	Papelera fabricada en chapa de hierro de 1,5 mm. La tapa batiente está sujeta al cuerpo de la papelera mediante 2 tornillos no visibles. Aro para sujetar la bolsa tipo mariposa incluido en el interior de la papelera. Unión de la base con el cuerpo de la papelera mediante soldadura. Base con tacos de goma para proteger la superficie donde se ubique. Icono indicador de residuo en vinilo.	<i>Corbeille fabriquée en tôle de 1,5 mm d'épaisseur. Le couvercle à charnière est fixé au corps de la poubelle à l'aide de 2 vis non visibles. Anneau pour maintenir le sac de type papillon inclus à l'intérieur de la corbeille. Union de la base et du corps de la corbeille soudé. Base avec des gommages de caoutchouc pour protéger la surface où elle se trouve. Icône d'indicateur de résidus en vinyle.</i>	Contentore in lamiera Ferro da 1,5 mm. Coperchio incernierato è attaccato al corpo del bidone utilizzando 2 viti non visibile. Anello per tenere il tipo di borsa farfalla inclusa all'interno del contenitore. Unione di base con il corpo del contenitore mediante saldatura. Base con borchie in gomma per proteggere il superficie dove si trova. Icona indicatore di residui di vinilo.

	REF	↕↔	
	<b>BER 02 T</b>	25 x 25 x 70 cm — 39,4 L 9,8 x 9,8 x 27,6 in. — 10,5 gal	9,4 kg 20,7 lb.
	<b>BER 03 T</b>	35 x 35 x 100 cm — 100 L 13,8 x 13,8 x 39,4 in. — 26,4 gal	18,7 kg 41,2 lb.

















ENVIRONMENTAL IMPACT				FIRE RESISTANCE	RÉSISTANCE AU FEU
				RESISTENCIA AL FUEGO	RESISTENZA AL FUOCO
Materials may be easily disassembled to be recycled.	Materiales fácilmente segregables para su posterior reciclado.	<i>Matériaux facilement démontables pour leurs recyclages.</i>	<i>Materiali facilmente separabile per un successivo riciclaggio.</i>	UNE-EN 13501-1	A1-s1, d0

WARRANTY	GARANTIA	GARANTIE	GARANZIA	PACKAGING	EMBALAJE	EMBALLAGE	IMBALLAGGIO
Two (2) year limited warranty. Does not cover: incorrect use, bad handling or deliberate damage.	Garantía de dos (2) años limitada. No cubre: mal uso, manipulación o daños intencionados.	<i>Garantie deux (2) ans. À l'exception: mauvaise utilisation, manipulation, dommages intentionnés.</i>	<i>Due (2) anni di garanzie limitati. Non copre: uso improprio, manipolazione o danno intenzionale.</i>	Cardboard box with plastic bag for product protection. One package.	Caja de cartón con bolsa de plástico para protección. Un paquete.	<i>Boîte en carton avec sac plastique pour la protection. Un paquet.</i>	<i>Scatola di cartone con sacchetto di plastica per protezione. Un pacco.</i>









BRAND COLORS

 BL · Ral 9003	 VD · Ral 6000
 CE · Ral 7033	 PE · Ral 5020
 GR · Ral 7015	 AZ · Ral 5009
 AN · Ral 7016	 BD · Ral 3005
 MA · Ral 8014	 RJ · Ral 3020
 OP · Ral 1036	 RS · Ral 2012
 VF · Ral 6020	 AM · Ral 1007
 VO · Ral 6011	 NJ · Ral 2017

RECYCLING COLORS





 RAL 9003 + 3027
 RAL 9003 + 1023
 RAL 9003 + 6016
 RAL 9003 + 5012
 RAL 9003 + 8025

CUSTOMIZE OPTIONS

OPCIONES PERSONALIZADAS

PERSONNALISER LES OPTIONS



OPZIONI DI PERSONALIZZAZIONE

 RAL COLOR	 TRASH BAG
 PICTOGRAMS	 HOLE ON LID







OPTIONAL HOLE

 OTHERS
--

TRASH BAG

 BAG 01 <b>(BER 02)</b>	54 x 60 cm 21,3 x 23,6 in.
 BAG 02 <b>(BER 03)</b>	85 x 105 cm 21,3 x 23,6 in.

LABELS

Thickness  1,5 mm	Acoustic  Doesn't absorb sound
Material  Iron	Fire resistance  UNE-EN 13501-1 A1-51,d0
Finish  Painting	Optimal Space  Indoor
Conductivity  100% *iron	Cleaning  Water & Drying
Volume  See page 62	Weight  See page 62



# Zurich

by Joan Gaspar

**A practical and functional modular waste bin thanks to its topopening lid. Its large capacity in liters and size does not hinder its easy emptying. Ideal for large areas with high foot traffic and the possibility to customize its design with graphics. Optional plastic bucket.**

Una papelera modular práctica y funcional gracias a su abertura con tapa superior. Su gran capacidad en litros y tamaño no impide su fácil achique. Ideal para grandes áreas con elevado tráfico de personas y posibilidad de personalizar su diseño mediante la gráfica. Opcional cubeta plástica.

*Une poubelle modulaire pratique et fonctionnelle grâce à son ouverture par le dessus. Sa grande capacité en litres et sa taille ne compromettent pas sa facilité de vidage. Idéal pour les grands espaces à fort trafic piétonnier et possibilité de personnaliser son design avec des graphiques. Seau en plastique en option.*

**Un cestino modulare pratico e funzionale grazie alla sua apertura con coperchio superiore. La sua grande capacità in litri e dimensioni non ostacola il suo facile svuotamento. Ideale per grandi aree con alto traffico di persone e possibilità di personalizzare il suo design tramite la grafica. Secchio di plastica opzionale.**



FLOOR

4

403 ———>>

<<———— 402  
408





GLASS



PAPER



PLASTIC



WASTE



RECYCLING



# More about Zurich

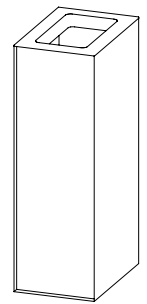

SCALE 1:20 (cm)

DESIGNER

Joan Gaspar

YEAR

2010 / 2014

LINE SKETCH

PRODUCT

REFERENCE

SIZE



**ZUR 01**

24 x 35 x 71 cm – 55 L  
9,4 x 13,8 x 28 in. – 14,5 gal



**ZUR 02**

24 x 35 x 40 cm – 30 L  
9,4 x 13,8 x 15,7 in. – 7,9 gal



**ZUR 03**

39 x 29 x 98 cm – 110 L  
15,4 x 11,4 x 38,6 in. – 29,1 gal



BAG HOLDER AND RING LID OPENING DETAIL – ZUR 03 + 9006    DETAIL LID – ZUR 03 + 9006



**ZUR 50**

27 x 22 x 66 cm — 40 L  
10,6 x 8,6 x 25,9 in. — 10,6 gal

Rotomolding Recycled (PVC)

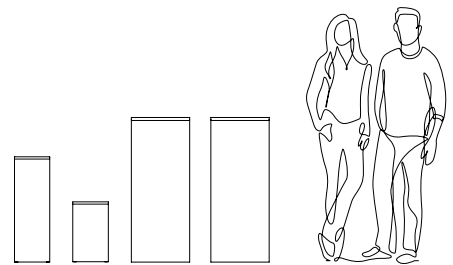

CUSTOMISED WITH VINYL GRAPHICS — ZUR 02

BAG HOLDER AND RING LID OPENING DETAIL — ZUR 01 + 1023

FLOOR  
4

ZERO  
(WASTE)





# More about Zurich +

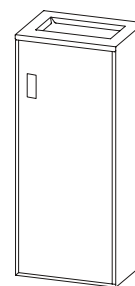

SCALE 1:10 (cm)

DESIGNER

Joan Gaspar

YEAR

2022

LINE SKETCH

PRODUCT

REFERENCE

SIZE



**ZUR 04**

39 x 29 x 98 cm — 110 L  
15,4 x 11,4 x 38,6 in. — 29,1 gal



OPENING FRONT DOOR / CUSTOMISED WITH VINYL GRAPHICS







# Zurich

by Joan Gaspar

← VIEW PRODUCT PAGES

64

CHARACTERISTICS	CARACTERÍSTICAS	CARACTÉRISTIQUES	CARATTERISTICHE
Bin made of 0.8 mm sheet metal. The ZUR 01 and ZUR 02 models are assembled by using rivets, including injected polycarbonate hinged cover. The ZUR 03 and ZUR 04 are welded in one piece with 1.5 mm metal sheet lid. Inner ring to hold bag included inside. Base includes rubber blocks to protect the surface where it is located. Vinyl residue indicator icon.	Papelera fabricada en chapa de hierro de 0,8 mm. El modelo ZUR 01 y 02 ensamblado mediante remaches, con tapa de policarbonato inyectado batiente. La ZUR 03 y 04 soldada en una pieza con tapa de chapa de hierro de 1,5 mm. Aro para sujetar la bolsa tipo mariposa incluido en el interior. Base con tacos de goma para proteger la superficie donde se ubique. Icono indicador de residuo en vinilo.	Corbeille fabriquée en tôle de 0,8 mm d'épaisseur. Les modèles ZUR 01 et 02 sont assemblés avec des rivets, et muni d'un couvercle articulé en polycarbonate injecté. La ZUR 03 et 04 est soudée d'une seule pièce avec un couvercle en tôle de 1,5 mm d'épaisseur. Anneau pour tenir le sac de type papillon inclus à l'intérieur. Base avec des gommages de caoutchouc pour protéger la surface où elle se trouve. Icône indicatif des résidus en vinyle.	Contentitore in lamiera ferro da 0,8 mm. I modelli ZUR 01 e 02 sono assemblati con rivetti e dotato di un coperchio articolato in polycarbonato iniettato. Lo ZUR 03 e 04 è saldato da un solo pezzo con coperchio in lamiera ferro da 1,5 mm. Anello per tenere la borsa a farfalle incluso dentro. Base con borchie in gomma per proteggere il superficie dove si trova. Icona indicatore dei residui di vinile.

REF	↕↔		REF	↕↔	
 <b>ZUR 01</b> <b>ZUR 01 IN</b>	24 x 35 x 71 cm — 55 L 9,5 x 13,8 x 28 in. — 14,5 gal	9 kg 19,8 lb.	 <b>ZUR 03</b> <b>ZUR 03 IN</b>	39 x 29 x 98 cm. — 110 L 15,4 x 11,4 x 38,6 in. — 29,1 gal	15 kg 33,06 lb.
 <b>ZUR 02</b> <b>ZUR 02 IN</b>	24 x 35 x 40 cm — 30 L. 9,5 x 13,8 x 15,7 in. — 7,9 gal	6 kg 13,2 lb.	 <b>ZUR 04</b> <b>ZUR 04 IN</b>	39 x 29 x 98 cm. — 110 L 15,4 x 11,4 x 38,6 in. — 29,1 gal	15 kg 33,06 lb.
			 <b>ZUR 50</b>	28,5 x 21,5 x 69,4 cm — 40 L 11,2 x 8,5 x 27,3 in. — 10,6 gal	1 kg 2,2 lb.

## ACCESORIES

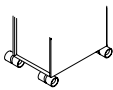







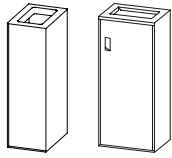









**ZUR 40**  
Castors

ENVIRONMENTAL IMPACT				FIRE RESISTANCE	RÉSISTANCE AU FEU
				RESISTENCIA AL FUEGO	RESISTENZA AL FUOCO
Materials may be easily disassembled to be recycled.	Materiales fácilmente segregables para su posterior reciclado.	Matériaux facilement démontables pour leurs recyclages.	Materiali facilmente separabile per un successivo riciclaggio.	UNE-EN 13501-1	A1-s1, d0

WARRANTY	GARANTIA	GARANTIE	GARANZIA	PACKAGING	EMBALAJE	EMBALLAGE	IMBALLAGGIO
Two (2) year limited warranty. Does not cover: incorrect use, bad handling or deliberate damage.	Garantía de dos (2) años limitada. No cubre: mal uso, manipulación o daños intencionados.	Garantie deux (2) ans. À l'exception: mauvaise utilisation, manipulation, dommages intentionnés.	Due (2) anni di garanzie limitati. Non copre: uso improprio, manipolazione o danno intenzionale.	Cardboard box with plastic bag for product protection. One package.	Caja de cartón con bolsa de plástico para protección. Un paquete.	Boîte en carton avec sac plastique pour la protection. Un paquet.	Scatola di cartone con sacchetto di plastica per protezione. Un pacco.



BRAND COLORS

- |  |   |
|--|---|
|  BL · Ral 9003 |  VD · Ral 6000 |
|  CE · Ral 7033 |  PE · Ral 5020 |
|  GR · Ral 7015 |  AZ · Ral 5009 |
|  AN · Ral 7016 |  BD · Ral 3005 |
|  MA · Ral 8014 |  RJ · Ral 3020 |
|  OP · Ral 1036 |  RS · Ral 2012 |
|  VF · Ral 6020 |  AM · Ral 1007 |
|  VO · Ral 6011 |  NJ · Ral 2017 |

OTHER FINISHES



-  INOX



CUSTOMIZE OPTIONS

OPCIONES PERSONALIZADAS

PERSONNALISER LES OPTIONS

OPZIONI DI PERSONALIZZAZIONE

-  RAL COLOR
-  PICTOGRAMS
-  HEIGHT & WIDTH

-  TRASH BAG
-  HOLE ON LID











STANDARD HOLE

- |               |             |
|---------------|-------------|
| OPTIONS:      | SIZE:       |
| Plastic cover | 18 x 32 cm  |
| Metal cover   | 12 x 31 in. |

TRASH BAG

- |   |   |
|---|---|
|  BAG 01 (ZUR/01-02) 54 x 60 cm<br>21,3 x 23,6 in. |  BAG 02 (ZUR/03-04) 85 x 105 cm<br>21,3 x 23,6 in. |
|---|---|

LABELS

- |   |   |
|---|---|
| Thickness  1,5 mm        | Acoustic  Doesn't absorb sound           |
| Material  Iron           | Fire resistance  UNE-EN 13501-1 A1-51,d0 |
| Finish  Painting         | Optimal Space  Indoor                    |
| Conductivity  100% *iron | Cleaning  Water & Drying                 |
| Volume  See page 72      | Weight  See page 72                      |



# Basilea

by Pep Puerto

**The simplest solution, metal construction, allows the use of colour and pictograms to choose the required types of waste. Includes an inner recycled plastic bin and handles for easy emptying, now also available with front sliding opening.**

La solución más simple, de construcción metálica, permite mediante el color y pictograma elegir los residuos deseados. Incluye una cubeta y unas asas para su cómodo vaciado, ahora también disponible una versión con apertura frontal.

*La solution la plus simple, de fabrication métallique, elle permet au travers de la couleur et du pictogramme de choisir les types de déchets souhaités. Comprend un seau interne en plastique et des poignées pour une vidange facile. Une version avec ouverture frontale est également disponible.*

**Colonne bianche che si trasformano, grazie ai loro coperchi colorati, con un gioco elegante e armonioso con grande capacità, ideale per spazi contract e Uffici. Coperchio pieghevole e inclinato ad evitare i deposito di rifiuti e il rilascio di odori. Puoi scegliere il modello tra due dimensioni per il tipo di rifiuto di cui hai bisogno.**









GLASS

PAPER

WASTE

RECYCLING

# More about Basilea

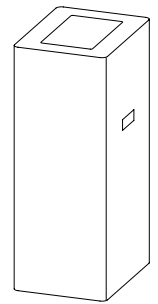

SCALE 1:20 (cm)

DESIGNER

Pep Puerto

YEAR

2015 / 2018

LINE SKETCH

PRODUCT

REFERENCE

SIZE



**BAS 01**

27 x 35 x 71 cm — 40 L  
10,6 x 13,8 x 27,9 in. — 10,6 gal.



**BAS 10**

27 x 35 x 71 cm — 55 L  
10,6 x 13,8 x 27,9 in. — 14,5 gal.



**ZUR 50**

27 x 22 x 66 cm — 40 L  
10,6 x 8,6 x 25,9 in. — 10,6 gal.

Rotomolding Recycled (PVC)



SET OF CONTAINERS WITH FRONT EXTRACTION SLIDING SYSTEM — BAS 10





INNER BINS AND UPPER EXTRACTION SYSTEM –  
BAS 01 + ZUR 50 (INCLUDED)  
LATERAL HANDLE – BAS 01 / 10



BASIC RECYCLING POINT – BAS 01



# Basilea

by Pep Puerto

← VIEW PRODUCT PAGES

74

CHARACTERISTICS	CARACTERÍSTICAS	CARACTÉRISTIQUES	CARATTERISTICHE
Bin made of 1.2mm sheet metal. Front of bin slides forward for removal of rubbish. Built-in ABS, plastic handles on the side of the body for handling. 40 liter plastic inner tank (ZUR 50) included for the BAS 01 version. Ring for the bag included inside the bin for the BAS 10 version. Vinyl waste indicator icon.	Papelera fabricada en chapa de hierro de 1,2mm. Frontal o cuerpo extraíble. Asas empotradas de plástico ABS en el lateral del cuerpo para su manipulación. Cubeta de plástico interior de 40 litros (ZUR 50) incluida para la versión BAS 01. Aro para la bolsa incluido en el interior de la papelera para la versión BAS 10. Icono indicador de residuo en vinilo.	Corbeille fabriquée en tôle de 1,2 mm d'épaisseur. Partie frontale ou corps amovible. Poignées en plastique ABS intégrées sur le côté du corps pour sa manipulation. Réservoir intérieur en plastique de 40 litres (ZUR 50) inclus pour la version BAS 01. Anneau pour maintenir le sac inclus à l'intérieur de la corbeille pour la version BAS 10. Icône d'indicateur de déchets en vinyle.	Contentitore in lamiera Ferro da 1,2 mm. Frontale o corpo rimovibile. Maniglie Plastica ABS incassate sul lato del corpo per la manipolazione. Serbatoio interno in plastica (ZUR 50) incluso per la versione BAS 01. Anello per tenere la borsa incluso all'interno del cestino per la versione BAS 10. Icona indicatore di rifiuti in vinile.

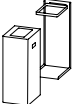















REF	↕↔	📦	REF	↕↔	📦
 <b>BAS 01</b>	24 x 35 x 70 cm — 40 L 9,4 x 13,8 x 27,6 in. — 10,6 gal.	7 kg 15,4 lb.	 <b>ZUR 50</b>	28,5 x 21,5 x 69,4 cm — 40 L 11,2 x 8,5 x 27,3 in. — 10,6 gal.	1 kg 2,2 lb.
 <b>BAS 10</b>	27 x 35 x 71 cm — 55 L 10,6 x 13,8 x 27,9 in. — 14,5 gal.	12 kg 26,5 lb.			

ENVIRONMENTAL IMPACT				FIRE RESISTANCE	RÉSISTANCE AU FEU
				RESISTENCIA AL FUEGO	RESISTENZA AL FUOCO
Materials may be easily disassembled to be recycled.	Materiales fácilmente segregables para su posterior reciclado.	Matériaux facilement démontables pour leurs recyclages.	Materiali facilmente separabile per un successivo riciclaggio.	UNE-EN 13501-1	A1-s1, d0

WARRANTY	GARANTIA	GARANTIE	GARANZIA	PACKAGING	EMBALAJE	EMBALLAGE	IMBALLAGGIO
Two (2) year limited warranty. Does not cover: incorrect use, bad handling or deliberate damage.	Garantía de dos (2) años limitada. No cubre: mal uso, manipulación o daños intencionados.	Garantie deux (2) ans. À l'exception: mauvaise utilisation, manipulation, dommages intentionnés.	Due (2) anni di garanzie limitati. Non copre: uso improprio, manipolazione o danno intenzionale.	Cardboard box with plastic bag for product protection. One package.	Caja de cartón con bolsa de plástico para protección. Un paquete.	Boîte en carton avec sac plastique pour la protection. Un paquet.	Scatola di cartone con sacchetto di plastica per protezione. Un pacco.



BRAND COLORS

 BL · Ral 9003	 VD · Ral 6000
 CE · Ral 7033	 PE · Ral 5020
 GR · Ral 7015	 AZ · Ral 5009
 AN · Ral 7016	 BD · Ral 3005
 MA · Ral 8014	 RJ · Ral 3020
 OP · Ral 1036	 RS · Ral 2012
 VF · Ral 6020	 AM · Ral 1007
 VO · Ral 6011	 NJ · Ral 2017

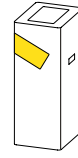





VINYL COLOURS

 BLUE
 GREEN
 YELLOW
 GREY
 BROWN
 RED

CUSTOMIZE OPTIONS  
OPCIONES PERSONALIZADAS

PERSONNALISER LES OPTIONS  
OPZIONI DI PERSONALIZZAZIONE

 RAL COLOR	 TRASH BAG
 PICTOGRAMS	 HOLE ON LID
 HEIGHT & WIDTH	











STANDARD HOLE

 HOL / SQ	11 x 11 cm 4,3 x 4,3 in.
--	-----------------------------

TRASH BAG

 BAG 02	85 x 105 cm 21,3 x 23,6 in.
---	--------------------------------

LABELS

Thickness  1,5 mm	Acoustic  Doesn't absorb sound
Material  Iron	Fire resistance  UNE-EN 13501-1 A1-51,d0
Finish  Painting	Optimal Space  Indoor
Conductivity  100% *iron	Cleaning  Water & Drying
Volume  See page 80	Weight  See page 80



# Zell

by Estudi Ribaudí

**Separate three, four, to five types of waste with this recycling station. It's perfect rectangular lines integrating beautifully in any environment. Almost going unnoticed.**

Separa los residuos, de tres, cuatro, o cinco tipos, con este contenedor de reciclaje. Sus líneas rectangulares perfectas se integrarán totalmente en tu espacio, llegando a pasar casi desapercibido.

*Séparez les déchets, de trois, quatre, ou cinq types, avec ce bac de recyclage. Ses lignes rectangulaires parfaites s'intégreront totalement à votre espace, arrivant presque à passer inaperçues.*

**Separare i rifiuti, di tre, quattro, o cinque tipi, con questo contenitore di riciclaggio. Le sue linee rettangolari perfette lo integrano perfettamente nel tuo spazio, a renderlo quasi inosservato.**









# More about Zell

DESIGNER

Estudi Ribaudí

YEAR

2015

LINE SKETCH

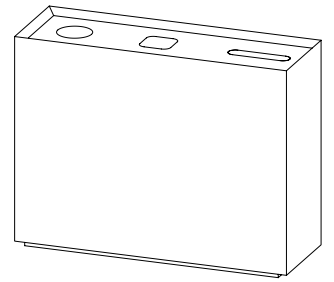

SCALE 1:25 (cm)

PRODUCT

REFERENCE

SIZE



**ZEL 03 / 03P**

95 x 32 x 74 cm — 120 L  
37,4 x 12,6 x 29,5 in. — 31,7 gal.  
P: Door version



**ZEL 04**

125 x 32 x 74 cm — 160 L  
49,2 x 12,6 x 29,1 in. — 42,3 gal.



**ZEL 05**

125 x 32 x 74 cm — 160 L  
49,2 x 12,6 x 29,1 in. — 42,3 gal.



RECYCLING STATION FOR FIVE TYPES OF WASTE. INNER BIN DETAIL — ZELL 05



PRODUCT

REFERENCE



**ZUR 50**

28,5 x 21,5 x 69,4 cm — 40 L  
11,2 x 8,5 x 27,3 in. — 10,6 gal.

ZEL 03 + 3 x ZUR 50 Included (Not 03P)  
ZEL 04 + 4 x ZUR 50 Included  
ZEL 05 + 4 x ZUR 50 Included

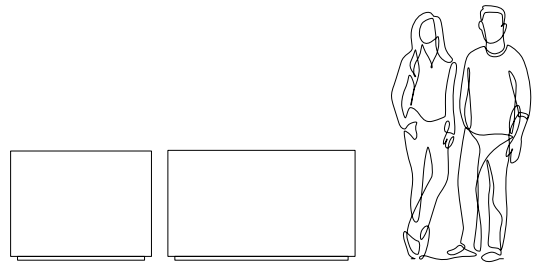

RING TO HOLD BAG AND DOORS FOR FRONTAL EXTRACTION SYSTEM DETAIL



LID AND COLOURED GRAPHICS FOR TYPES OF WASTE — ZELL 05





# Zell

by Estudi Ribaudí

← VIEW PRODUCT PAGES

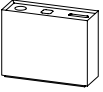
82

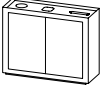
CHARACTERISTICS	CARACTERÍSTICAS	CARACTÉRISTIQUES	CARATTERISTICHE
Bin made from 1.5 mm sheet metal. Unified by welding. The hinged lid is attached to the trash can body with 2 non visible screws. 40 liter plastic inner trays (ZUR 50) included. Base includes rubber blocks to protect the surface where it is located. Vinyl residue indicator icon.	Papelera fabricada en chapa de hierro de 1,5 mm. Cuerpo unido mediante soldadura. La tapa batiente está sujeta al cuerpo de la papelera mediante 2 tornillos no visibles. Cubetas de plástico interiores de 40 litros (ZUR 50) incluidas. Base con tacos de goma para proteger la superficie donde se ubique. Icono indicador de residuo en vinilo.	<i>Corbeille fabriquée en tôle de 1,5 mm d'épaisseur. Corps uni par soudure. Le couvercle à charnière est fixé au corps de la poubelle à l'aide de 2 vis non visibles. Bacs intérieurs en plastique de 40 litres (ZUR 50) inclus. Base avec des gommages de caoutchouc pour protéger la surface où elle se trouve. Icône d'indicateur de résidus en vinyle.</i>	<i>Contentitore in lamiera ferro da 1,5 mm. Corpo uniti mediante saldatura. Il coperchio oscillante è attaccato al corpo del contenitore mediante 2 viti non visibili. Secchi Interni in plastica da 40 litri. (ZUR 50) incluso. Base con borchie in gomma per proteggere il superficie dove si trova. Icona indicatore di residui di vinile.</i>
The version with hinged doors, incorporates ring to hold the bag.	La versión con puertas batientes, incorpora aro para sujetar la bolsa.	<i>La version à portes battantes comprend un anneau pour maintenir le sac.</i>	<i>La versione con ante battenti, incorpora un anello per tenere la borsa.</i>







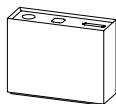









REF	↕↔	📏	REF	↕↔	📏
	<b>ZEL 03</b>	95 x 32 x 75 cm — 120 L 37,4 x 12,6 x 29,5 in. — 31,7 gal. 3x ZUR 50 Included		<b>ZEL 05</b>	125 x 32 x 75 cm — 160 L 49,2 x 12,6 x 29,5 in. — 42,3 gal. 4x ZUR 50 Included
	<b>ZEL 03P</b>	95 x 32 x 75 cm — 120 L 37,4 x 12,6 x 29,5 in. — 31,7 gal. P: Door version		<b>ZUR 50</b>	28,5 x 21,5 x 69,4 cm — 40 L 11,2 x 8,5 x 27,3 in. — 10,6 gal. 1 kg 2,2 lb.
	<b>ZEL 04</b>	125 x 32 x 75 cm — 160 L 49,2 x 12,6 x 29,5 in. — 42,3 gal.			35 kg 77,2 lb.

ENVIRONMENTAL IMPACT				FIRE RESISTANCE	RÉSISTANCE AU FEU
				RESISTENCIA AL FUEGO	RESISTENZA AL FUOCO
Materials may be easily disassembled to be recycled.	Materiales fácilmente segregables para su posterior reciclado.	<i>Matériaux facilement démontables pour leurs recyclages.</i>	<i>Materiali facilmente separabile per un successivo riciclaggio.</i>	UNE-EN 13501-1	A1-s1, d0

WARRANTY	GARANTIA	GARANTIE	GARANZIA	PACKAGING	EMBALAJE	EMBALLAGE	IMBALLAGGIO
Two (2) year limited warranty. Does not cover: incorrect use, bad handling or deliberate damage.	Garantía de dos (2) años limitada. No cubre: mal uso, manipulación o daños intencionados.	<i>Garantie deux (2) ans. À l'exception: mauvaise utilisation, manipulation, dommages intentionnés.</i>	<i>Due (2) anni di garanzie limitati. Non copre: uso improprio, manipolazione o danno intenzionale.</i>	Cardboard box with plastic bag for product protection. One package.	Caja de cartón con bolsa de plástico para protección. Un paquete.	<i>Boîte en carton avec sac plastique pour la protection. Un paquet.</i>	<i>Scatola di cartone con sacchetto di plastica per protezione. Un pacco.</i>



#### BRAND COLORS

 BL · Ral 9003	 VD · Ral 6000
 CE · Ral 7033	 PE · Ral 5020
 GR · Ral 7015	 AZ · Ral 5009
 AN · Ral 7016	 BD · Ral 3005
 MA · Ral 8014	 RJ · Ral 3020
 OP · Ral 1036	 RS · Ral 2012
 VF · Ral 6020	 AM · Ral 1007
 VO · Ral 6011	 NJ · Ral 2017

#### VINYL COLOURS

 BLUE
 GREEN
 YELLOW
 GREY
 BROWN
 RED

#### OTHER FINISHES





 INOX
--

#### CUSTOMIZE OPTIONS



OPCIONES PERSONALIZADAS

#### PERSONNALISER LES OPTIONS

OPZIONI DI PERSONALIZZAZIONE

 RAL COLOR	 TRASH BAG
 PICTOGRAMS	 HOLE ON LID
 HEIGHT & WIDTH	











#### STANDARD HOLE

ZEL 03		HOL / CR	ø 12 cm
ZEL 04			ø 4,7 in.
ZEL 05		HOL / SQ	11 x 11 cm
			4,3 x 4,3 in.
		HOL / PA	5 x 25 cm
			1,9 x 9,8 in.

#### TRASH BAG

 BAG 02	85 x 105 cm
	21,3 x 23,6 in.

#### LABELS

Thickness  1,5 mm	Acoustic  Doesn't absorb sound
Material  Iron	Fire resistance  UNE-EN 13501-1 A1-51,d0
Finish  Painting	Optimal Space  Indoor
Conductivity  100%	Cleaning  Water & Drying
Volume  See page 88	Weight  See page 88



# Interlaken

by Plumartis

A set of recycling containers that will enhance any interior, attracting the attention of passersby. Made of acquered sheet metal, with a removable top, colour and shape will determine which types of waste.

Un conjunto de contenedores de reciclaje que vestirá cualquier espacio, atraerá la vista de quien pase por delante por su simpatía. Fabricado en chapa de acero lacada, con un cabezal extraíble, de color y forma que determinará el residuo.

*Un ensemble de conteneurs de recyclage qui habillera n'importe quel espace, attirera la vue de ceux qui passent par leur sympathie. Fabriqué en tôle d'acier laquée, avec un couvercle amovible, une couleur et une forme qui détermineront le résidu.*

Un insieme di contenitori per il riciclaggio che arrederà il tuo spazio e attirerà lo sguardo di chi ci passa davanti per la sua simpatia. Manufatto in lamiera d'acciaio laccata, con testa removibile, di colore e forma che determinerà il residuo.









# More about Interlaken

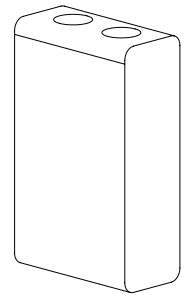

SCALE 1:20 (cm)

DESIGNER

Plumartis

YEAR

2019

LINE SKETCH

PRODUCT

REFERENCE

SIZE

LID OPTIONS



**INT 01 A/B/C/D** 40 x 20 x 35 cm – 24,7 L  
17,7 x 7,9 x 13,8 in. – 6,5 gal.

 A - PLASTIC



**INT 02 A/B/C/D** 40 x 20 x 45 cm – 32,7 L  
17,7 x 7,9 x 17,7 in. – 8,6 gal.

 B - PAPER



**INT 03 A/B/C/D** 40 x 20 x 55 cm – 40,7 L  
17,7 x 7,9 x 21,7 in. – 10,8 gal.

 C - GLASS

 D - WASTE

 OTHERS



BIN LID EXTRACTION DETAIL – INT 03 C



PRODUCT	REFERENCE	SIZE
	<b>INT 04 A/B/C/D</b>	40 x 20 x 65 cm — 48,7 L 17,7 x 7,9 x 25,6 in. — 12,9 gal.

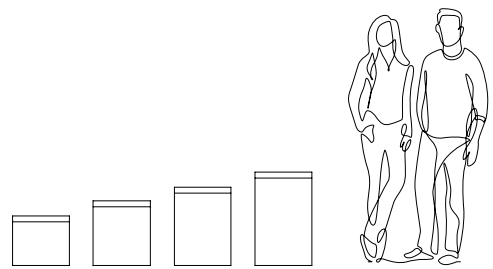

BAG RING DETAIL — INT 03



INTERLAKEN FAMILY







# Interlaken

by Plumartis

← VIEW PRODUCT PAGES

90

CHARACTERISTICS	CARACTERÍSTICAS	CARACTÉRISTIQUES	CARATTERISTICHE
Bin made from 1.5 mm sheet metal. Unified by welding. The hinged lid is attached to the trash can body with 2 non visible screws. 40 liter plastic inner trays (ZUR 50) included. Base includes rubber blocks to protect the surface where it is located. Vinyl residue indicator icon.	Papelera fabricada en chapa de hierro de 1,5 mm. Cuerpo unido mediante soldadura. La tapa batiente está sujeta al cuerpo de la papelera mediante 2 tornillos no visibles. Cubetas de plástico interiores de 40 litros (ZUR 50) incluidas. Base con tacos de goma para proteger la superficie donde se ubique. Icono indicador de residuo en vinilo.	<i>Corbeille fabriquée en tôle de 1,5 mm d'épaisseur. Corps uni par soudure. Le couvercle à charnière est fixé au corps de la poubelle à l'aide de 2 vis non visibles. Bacs intérieurs en plastique de 40 litres (ZUR 50) inclus. Base avec des gommages de caoutchouc pour protéger la surface où elle se trouve. Icône d'indicateur de résidus en vinyle.</i>	<i>Contentitore in lamiera ferro da 1,5 mm. Corpo uniti mediante saldatura. Il coperchio oscillante è attaccato al corpo del contenitore mediante 2 viti non visibili. Secchi Interni in plastica da 40 litri. (ZUR 50) incluso. Base con borchie in gomma per proteggere il superficie dove si trova. Icona indicatore di residui di vinile.</i>
The version with hinged doors, incorporates ring to hold the bag.	La versión con puertas batientes, incorpora aro para sujetar la bolsa.	<i>La version à portes battantes comprend un anneau pour maintenir le sac.</i>	<i>La versione con ante battenti, incorpora un anello per tenere la borsa.</i>







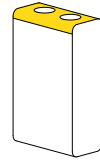
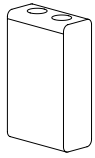













	REF	↕↔			REF	↕↔	
	<b>INT 01 A/B/C/D</b>	40 x 20 x 35 cm — 24,7 L 17,7 x 7,9 x 13,8 in. — 6,5 gal.	7,4 kg 16,3 lb.		<b>INT 02 A/B/C/D</b>	40 x 20 x 45 cm — 32,7 L 17,7 x 7,9 x 17,7 in. — 8,6 gal.	8,7 kg 19,2 lb.
	<b>INT 03 A/B/C/D</b>	40 x 20 x 55 cm — 40,7 L 17,7 x 7,9 x 21,7 in. — 10,8 gal.	10 kg 22 lb.		<b>INT 04 A/B/C/D</b>	40 x 20 x 65 cm — 48,7 L 17,7 x 7,9 x 25,6 in. — 12,9 gal.	11,3 kg 24,9 lb.

ENVIRONMENTAL IMPACT				FIRE RESISTANCE	RÉSISTANCE AU FEU
				RESISTENCIA AL FUEGO	RESISTENZA AL FUOCO
Materials may be easily disassembled to be recycled.	Materiales fácilmente segregables para su posterior reciclado.	<i>Matériaux facilement démontables pour leurs recyclages.</i>	<i>Materiali facilmente separabile per un successivo riciclaggio.</i>	UNE-EN 13501-1	A1-s1, d0





WARRANTY	GARANTIA	GARANTIE	GARANZIA	PACKAGING	EMBALAJE	EMBALLAGE	IMBALLAGGIO
Two (2) year limited warranty. Does not cover: incorrect use, bad handling or deliberate damage.	Garantía de dos (2) años limitada. No cubre: mal uso, manipulación o daños intencionados.	<i>Garantie deux (2) ans. À l'exception: mauvaise utilisation, manipulation, dommages intentionnés.</i>	<i>Due (2) anni di garanzie limitati. Non copre: uso improprio, manipolazione o danno intenzionale.</i>	Cardboard box with plastic bag for product protection. One package.	Caja de cartón con bolsa de plástico para protección. Un paquete.	<i>Boîte en carton avec sac plastique pour la protection. Un paquet.</i>	<i>Scatola di cartone con sacchetto di plastica per protezione. Un pacco.</i>



BRAND COLORS

 BL · Ral 9003	 VD · Ral 6000	 RAL 9003 + 1023
 CE · Ral 7033	 PE · Ral 5020	 RAL 9003 + 6016
 GR · Ral 7015	 AZ · Ral 5009	 RAL 9003 + 5012
 AN · Ral 7016	 BD · Ral 3005	 RAL 9003 + 8025
 MA · Ral 8014	 RJ · Ral 3020	
 OP · Ral 1036	 RS · Ral 2012	
 VF · Ral 6020	 AM · Ral 1007	
 VO · Ral 6011	 NJ · Ral 2017	

LID OPTIONS

 A - PLASTIC	 C - GLASS
 B - PAPER	 D - WASTE

CUSTOMIZE OPTIONS



OPCIONES PERSONALIZADAS

PERSONNALISER LES OPTIONS

OPZIONI DI PERSONALIZZAZIONE

 RAL COLOR	 TRASH BAG
 HEIGHT & WIDTH	 HOLE ON LID











STANDARD HOLE

 HOL / CR	ø 12 cm ø 4,7 in.
 HOL / PA	5 x 25 cm 1,9 x 9,8 in.

TRASH BAG

 BAG 01	54 x 60 cm 21,3 x 23,6 in.
---	-------------------------------

LABELS

Thickness  1,5 mm	Acoustic  Doesn't absorb sound
Material  Iron	Fire resistance  UNE-EN 13501-1 A1-51,d0
Finish  Painting	Optimal Space  Indoor
Conductivity  100% iron	Cleaning  Water & Drying
Volume  See page 96	Weight  See page 96

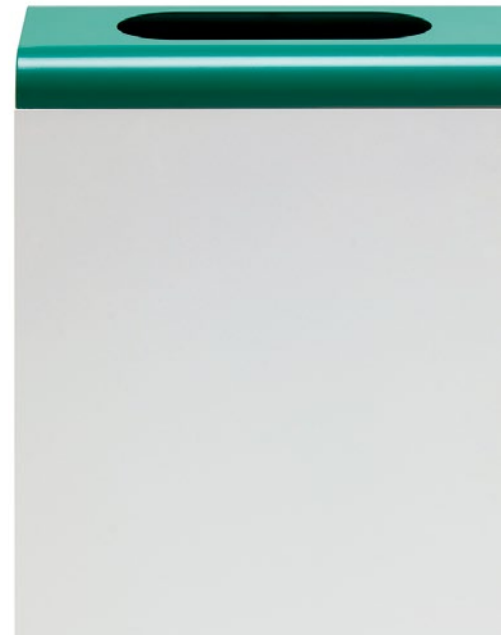

# Baden

by Roger Vancells

A robust, high-capacity bin ideal for public areas. Large opening with a practical door for emptying and maintenance. Also available with an ashtray on top.

Una papelera robusta, de gran capacidad que es ideal para espacios públicos. Boca de gran tamaño con una práctica puerta para su vaciado y mantenimiento. Disponible versión con cenicero en su parte superior.

*Une corbeille à papier robuste et de grande capacité, idéale pour les espaces publics. Grande ouverture avec une porte pratique pour sa vidange et sa maintenance. Version disponible avec cendrier sur le dessus.*

Un bidone robusto, con grande capacità è ideale per gli spazi pubblici. Grande circonferenza con una pratica porta per lo svuotamento e manutenzione. È disponibile la versione con posacenere nella sua parte superiore.









# More about Baden

DESIGNER

Roger Vancells

YEAR

2017

LINE SKETCH

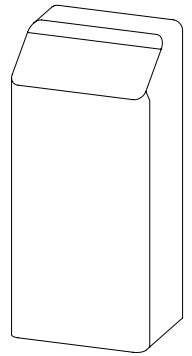

SCALE 1:20 (cm)

PRODUCT

REFERENCE

SIZE



**BDN 01**

45 x 35,5 x 100 cm — 100 L  
17,7 x 14 x 39,3 in. — 26,4 gal.



LARGE CAPACITY RECYCLING POINT - BDN 01



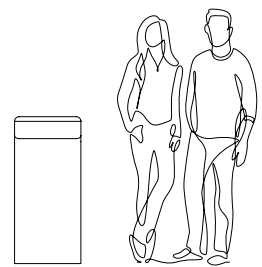

LOOK DETAIL - BDN 01



SUPERIOR LID WITH WASTE IDENTIFIER - BDN 01

# Baden

by Roger Vancells

← VIEW PRODUCT PAGES

98

CHARACTERISTICS	CARACTERÍSTICAS	CARACTÉRISTIQUES	CARATTERISTICHE
Bin made from 1.5 mm sheet metal. Body unified by welding. Front swing door for the extraction of the inner bag. Lock with key included. It incorporates bag hoop inside the bin. Base includes rubber blocks to protect the surface where it is located. Vinyl residue indicator icon.	Papelera fabricada en chapa de hierro de 1,5 mm. Cuerpo unido mediante soldadura. Puerta batiente frontal para la extracción de la bolsa interior. Cerradura con llave incluida. Incorpora aro porta bolsa en el interior de la papelera. Base con tacos de goma para proteger la superficie donde se ubique. Icono indicador de residuo en vinilo.	Corbeille en tôle de 1,5 mm d'épaisseur. Corps uni par soudure. Porte battante avant pour l'extraction du sac intérieur. Serrure avec clé incluse. Elle intègre un anneau à l'intérieur pour maintenir le sac. Base avec des gommages de caoutchouc pour protéger la surface où elle se trouve. Icône d'indicateur de résidu en vinyle.	Contenitore in lamiera Ferro da 1,5 mm. Corpo uniti mediante saldatura. Porta a battente anteriore per rimozione della sacca interna. Serratura con chiave inclusa. Incorpora un anello portasci bag nel all'interno del contenitore. Base con borchie in gomma per proteggere il superficie dove si trova. Icona indicatore di residui di vinile.







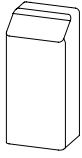









REF	↕↔	📏
 <b>BDN 01</b>	45 x 35,5 x 100 cm — 100 L 17,7 x 14 x 39,3 in. — 26,4 gal.	31 kg 68,3 lb.

ENVIRONMENTAL IMPACT				FIRE RESISTANCE	RÉSISTANCE AU FEU
				RESISTENCIA AL FUEGO	RESISTENZA AL FUOCO
Materials may be easily disassembled to be recycled.	Materiales fácilmente segregables para su posterior reciclado.	<i>Matériaux facilement démontables pour leurs recyclages.</i>	<i>Materiali facilmente separabile per un successivo riciclaggio.</i>	UNE-EN 13501-1	A1-s1, d0

WARRANTY	GARANTIA	GARANTIE	GARANZIA	PACKAGING	EMBALAJE	EMBALLAGE	IMBALLAGGIO
Two (2) year limited warranty. Does not cover: incorrect use, bad handling or deliberate damage.	Garantía de dos (2) años limitada. No cubre: mal uso, manipulación o daños intencionados.	<i>Garantie deux (2) ans. À l'exception: mauvaise utilisation, manipulation, dommages intentionnés.</i>	<i>Due (2) anni di garanzie limitati. Non copre: uso improprio, manipolazione o danno intenzionale.</i>	Cardboard box with plastic bag for product protection. One package.	Caja de cartón con bolsa de plástico para protección. Un paquete.	<i>Boîte en carton avec sac plastique pour la protection. Un paquet.</i>	<i>Scatola di cartone con sacchetto di plastica per protezione. Un pacco.</i>







BRAND COLORS

 BL · Ral 9003	 VD · Ral 6000
 CE · Ral 7033	 PE · Ral 5020
 GR · Ral 7015	 AZ · Ral 5009
 AN · Ral 7016	 BD · Ral 3005
 MA · Ral 8014	 RJ · Ral 3020
 OP · Ral 1036	 RS · Ral 2012
 VF · Ral 6020	 AM · Ral 1007
 VO · Ral 6011	 NJ · Ral 2017

CUSTOMIZE OPTIONS  
OPCIONES PERSONALIZADAS











PERSONNALISER LES OPTIONS  
OPZIONI DI PERSONALIZZAZIONE

 RAL COLOR	 TRASH BAG
 HEIGHT & WIDTH	 PICTOGRAMS

TRASH BAG

 BAG 02	85 x 105 cm 21,3 x 23,6 in.
---	--------------------------------

LABELS

Thickness  1,5 mm	Acoustic  Doesn't absorb sound
Material  Iron	Fire resistance  UNE-EN 13501-1 A1-51,d0
Finish  Painting	Optimal Space  Indoor
Conductivity  100% iron	Cleaning  Water & Drying
Volume  100 L / 26,4 gal	Weight  31 kg / 68,3 lb. unit



# Thun

by Plumartis

**A versatile litter bin, capable of adapting to any environment. Thanks to its pedal operation, you can recycle without touching it, and as it is fitted with a lid, the waste remains hidden. It is available in 3 sizes and the option of pictogram and colour combinations.**

Una papelera versátil, capaz de adaptarse a cualquier entorno. Gracias a su accionamiento mediante pedal, reciclas sin tocarla, y al estar provista de tapa, los residuos quedan ocultos. Disponible en 3 tamaños, combinación de pictograma y color.

*Une poubelle polyvalente, capable de s'adapter à tous les environnements. Grâce à son fonctionnement à pédale, vous pouvez recycler sans la toucher, elle comme elle possède un couvercle, les déchets restent cachés. Disponible en 3 tailles ainsi que plusieurs combinaisons de pictogramme et de couleur.*

**Un cestino versatile, capace di adattarsi a qualsiasi ambiente. Grazie al suo funzionamento a pedale, puoi riciclare senza toccarlo, e dato che ha un coperchio, i rifiuti rimangono nascosti. Disponibile in 3 dimensioni e combinazione di pittogramma e colore.**









ALUMINIUM



PAPER



BOTTLES  
CANS



GLASS



BATTERIES

# More about Thun

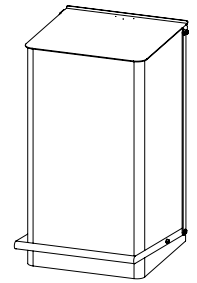

SCALE 1:20 (cm)

DESIGNER

Plumartis

YEAR

2022

LINE SKETCH

PRODUCT

REFERENCE

SIZE



**THU 01**

60 x 32,3 x 32,15 cm — 60 L  
23,6 x 12,7 x 12,6 in. — 15,8 gal.



**THU 02**

80 x 32,3 x 32,15 cm — 80 L  
31,4 x 12,7 x 12,6 in. — 21,1 gal.

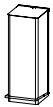

**THU 03**

100 x 32,3 x 32,15 cm — 100 L  
39,3 x 12,7 x 12,6 in. — 26,4 gal.



COMPLETE RECYCLING POINT FOR DIFFERENT TYPES OF WASTE



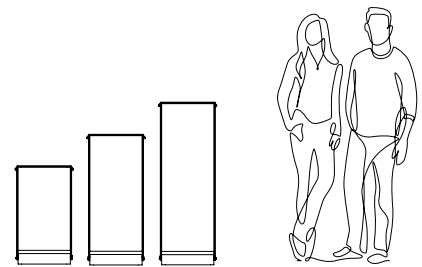

SUPERIOR LID WITH WASTE IDENTIFIER / LID WITH BRAKING SYSTEM



PEDAL-OPENING



# Thun

by Plumartis

← VIEW PRODUCT PAGES

106

CHARACTERISTICS	CARACTERÍSTICAS	CARACTÉRISTIQUES	CARATTERISTICHE
Pedal bin, made with 1.5mm metal sheet and it also includes a ring holder for the inside bag. Available in 3 height sizes. Base includes rubber studs to protect the surface where the bin is located.	Papelera con accionamiento visto a pedal fabricada en chapa de hierro de 1,5 mm. Aro para sujetar la bolsa incluido en el interior de la papelera. Disponible en 3 tamaños 60, 80 y 100 cm de altura. Base con tacos de goma para proteger la superficie donde se ubique.	Poubelle à pédale avec mécanisme visible, en tôle de fer de 1,5 mm d'épaisseur. Anneau pour maintenir le sac inclus à l'intérieur du bac. Disponible en 3 tailles 60, 80 et 100 cm de hauteur. Base avec des niveleurs en caoutchouc pour protéger la surface où elle se trouve.	Contenitore con azionamento a pedale a vista realizzato in lamiera di ferro da 1,5 mm. Anello per contenere il sacchetto incluso all'interno del cestino. Disponibile in 3 misure 60, 80 e 100 cm di altezza. Base con borchie in gomma per proteggere la superficie dove si trova.

	REF	↕↔	📏
	THU 01	60 x 32,3 x 32,15 cm — 60 L 23,6 x 12,7 x 12,6 in. — 15,8 gal.	14 kg 30,9 lb.
	THU 02	80 x 32,3 x 32,15 cm — 80 L 31,5 x 12,7 x 12,6 in. — 21,1 gal.	17 kg 37,5 lb.
	THU 03	100 x 32,3 x 32,15 cm — 100 L 39,4 x 12,7 x 12,6 in. — 26,4 gal.	20 kg 44,1 lb.

ENVIRONMENTAL IMPACT				FIRE RESISTANCE	RÉSISTANCE AU FEU
				RESISTENCIA AL FUEGO	RESISTENZA AL FUOCO
Materials may be easily disassembled to be recycled.	Materiales fácilmente segregables para su posterior reciclado.	Matériaux facilement démontables pour leurs recyclages.	Materiali facilmente separabile per un successivo riciclaggio.	UNE-EN 13501-1	A1-s1, d0

WARRANTY	GARANTIA	GARANTIE	GARANZIA	PACKAGING	EMBALAJE	EMBALLAGE	IMBALLAGGIO
Two (2) year limited warranty. Does not cover: incorrect use, bad handling or deliberate damage.	Garantía de dos (2) años limitada. No cubre: mal uso, manipulación o daños intencionados.	Garantie deux (2) ans. À l'exception: mauvaise utilisation, manipulation, dommages intentionnés.	Due (2) anni di garanzie limitati. Non copre: uso improprio, manipolazione o danno intenzionale.	Cardboard box with plastic bag for product protection. One package.	Caja de cartón con bolsa de plástico para protección. Un paquete.	Boîte en carton avec sac plastique pour la protection. Un paquet.	Scatola di cartone con sacchetto di plastica per protezione. Un pacco.

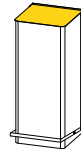
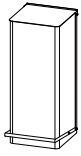

BRAND COLORS

	BL · Ral 9003		VD · Ral 6000		RAL 9003 + 1023
	CE · Ral 7033		PE · Ral 5020		RAL 9003 + 6016
	GR · Ral 7015		AZ · Ral 5009		RAL 9003 + 5012
	AN · Ral 7016		BD · Ral 3005		RAL 9003 + 8025
	MA · Ral 8014		RJ · Ral 3020		RAL 9003 + 3027
	OP · Ral 1036		RS · Ral 2012		
	VF · Ral 6020		AM · Ral 1007		
	VO · Ral 6011		NJ · Ral 2017		

CUSTOMIZE OPTIONS

OPCIONES PERSONALIZADAS

PERSONNALISER LES OPTIONS

OPZIONI DI PERSONALIZZAZIONE

	RAL COLOR		TRASH BAG
	HEIGHT & WIDTH		PICTOGRAMS

TRASH BAG

	<b>BAG 01 (THU 01)</b>	54 x 60 cm 21,3 x 23,6 in.
	<b>BAG 02 (THU 02/03)</b>	85 x 105 cm 21,3 x 23,6 in.

LABELS

Thickness		1,5 mm	Acoustic		Doesn't absorb sound
Material		Iron	Fire resistance		UNE-EN 13501-1 A1-51,d0
Finish		Painting	Optimal Space		Indoor
Conductivity		100% *iron	Cleaning		Water & Drying
Volume		See page 112	Weight		See page 112



# Biel

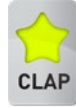

by Ximo Roca Diseño

**Down with boring offices! This perhaps is the most fun wastebasket in the world... for under desk use, made with injected plastic and available in four colours. If you prefer non-standard colours tell us and we can personalise the colour and logo.**

¡Basta de oficinas aburridas! Quizás sea la papelera más divertida del mundo... papelera de bajo mesa inyectada en plástico y disponible en cuatro colores. Si no te gustan nuestros colores, puede fabricarse en colores especiales e incluso personalizarse con un logo.

*Assez des bureaux ennuyeux! C'est peut-être a poubelle la plus drôle au monde ... une corbeille à papier injectée en plastique et disponible en quatre couleurs. Si vous n'aimez pas nos couleurs, vous pouvez la personnaliser et même la personnaliser avec un logo.*

¡Basta con gli uffici noiosi! Forse è il cestino più divertente del mondo... cestino da scrivania in plastica stampata a iniezione, disponibile in quattro colori. Se non ti piacciono i nostri colori, può essere realizzato in colori speciali e persino personalizzato con un logo.









# More about Biel

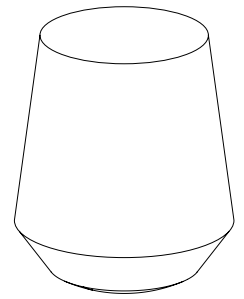

SCALE 1:10 (cm)

DESIGNER

Ximo Roca Diseño

YEAR

2016

LINE SKETCH

PRODUCT

REFERENCE

SIZE



**BIE 01**

Ø30 x 36 cm — 18 L  
Ø11,8 x 14,2 in. — 4,8 gal.



BASE DETAIL, WHICH MAKES THE PAPER BASKET OSCILLATE, WITHOUT FALLING OVER — BIE 01 2003



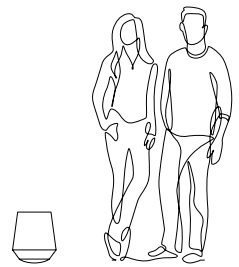



BIEL FAMILY

# Biel

by Ximo Roca Diseño

← VIEW PRODUCT PAGES





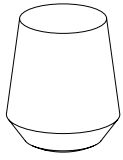

114

CHARACTERISTICS	CARACTERÍSTICAS	CARACTÉRISTIQUES	CARATTERISTICHE
Bin made using polypropylene injection. Manufactured in two coloured plastic pieces with an inner sheet metal disk weighing 400 grams to give stability to the base of the bin.	Papelera fabricada en inyección de polipropileno. Fabricada en dos piezas plásticas de color con disco interior de chapa de hierro de 400 gramos de peso para darle estabilidad a la base de la papelera.	<i>Corbeille fabriquée en injection de polypropylène. Fabriquée en deux pièces de plastique colorées avec un disque intérieur en tôle de 400 grammes pour donner une stabilité à la base de la corbeille.</i>	<i>Cestino realizzata in iniezione di polipropilene. Prodotto in due pezzi di plastica colorati con disco interno di lamiera di ferro di 400 Gr. di peso per darvi stabilità alla base del cestino.</i>
	REF	↕↔	
	<b>BIE 01</b>	Ø30 x 36 cm — 18 L Ø11,8 x 14,2 in. — 4,8 gal.	1,6 kg 3,5 lb.

ENVIRONMENTAL IMPACT				FIRE RESISTANCE	RÉSISTANCE AU FEU		
				RESISTENCIA AL FUEGO	RESISTENZA AL FUOCO		
Materials may be easily disassembled to be recycled.	Materiales fácilmente segregables para su posterior reciclado.	<i>Matériaux facilement démontables pour leurs recyclages.</i>	<i>Materiali facilmente separabile per un successivo riciclaggio.</i>	UNE-EN 13501-1	A1-s1, d0		
WARRANTY	GARANTIA	GARANTIE	GARANZIA	PACKAGING	EMBALAJE	EMBALLAGE	IMBALLAGGIO
Two (2) year limited warranty. Does not cover: incorrect use, bad handling or deliberate damage.	Garantía de dos (2) años limitada. No cubre: mal uso, manipulación o daños intencionados.	<i>Garantie deux (2) ans. À l'exception: mauvaise utilisation, manipulation, dommages intentionnés.</i>	<i>Due (2) anni di garanzie limitati. Non copre: uso improprio, manipolazione o danno intenzionale.</i>	Cardboard box with plastic bag for product protection. One package.	Caja de cartón con bolsa de plástico para protección. Un paquete.	<i>Boîte en carton avec sac plastique pour la protection. Un paquet.</i>	<i>Scatola di cartone con sacchetto di plastica per protezione. Un pacco.</i>













BRAND COLORS

	RAL 9003		RAL 7015
	RAL 2003		RAL 6020
	RAL 5012		RAL 9011

CUSTOMIZE OPTIONS      PERSONNALISER LES OPTIONS  
OPCIONES PERSONALIZADAS      OPZIONI DI PERSONALIZZAZIONE

 RAL COLOR

LABELS

Thickness		1,5 mm	Acoustic		Doesn't absorb sound
Material		Plastic	Fire resistance		UNE-EN 13501-1 A1-51,d0
Finish		Injected	Optimal Space		Indoor
Conductivity		No	Cleaning		Water & Drying
Volume		18 L / 4,8 gal	Weight		1,6 kg / 3,5 lb. unit



# Winterthur

by MD Design Lab

**Metal waste bin collection (optional with wooden lid) for a single type of waste, designed for office spaces, meeting rooms, hotel rooms, or the home. Ideal for smallscale recycling... because every gram of waste counts. Available in 16 colors.**

Colección de papelera metálica (opcional con tapa de madera) de un residuo pensada para espacios de oficina, salas de reuniones, habitaciones de hotel, o para el hogar. Ideal para reciclar a pequeña escala... porque cada gramo de residuo, cuenta.  
Disponible en 16 colores.

*Collection de poubelles métalliques (optionnel avec couvercle en bois) pour un seul type de déchet, conçue pour les espaces de bureau, les salles de réunion, les chambres d'hôtel, ou la maison. Idéale pour le recyclage à petite échelle... parce que chaque gramme de déchet compte.  
Disponible en 16 couleurs.*

**Collezione di cestini metallici (opzionale con coperchio in legno) per un singolo tipo di rifiuto, pensata per spazi di ufficio, sale riunioni, camere d'albergo o per la casa. Ideale per il riciclaggio su piccola scala... perché ogni grammo di rifiuto conta. Disponibile in 16 colori.**









# More about Winterthur

DESIGNER

by MD Design Lab

YEAR

2024

LINE SKETCH

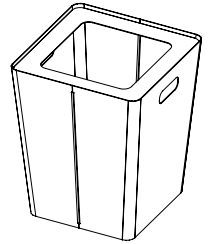

SCALE 1:10 (cm)

PRODUCT

REFERENCE

SIZE

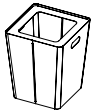

**WIN 01**

25 x 25 x 30 cm — 14,2 L  
9,8 x 9,8 x 11,8 in. — 3,7 gal.



PARTS OF THE BIN



OPTIONAL WASTE INDICATOR



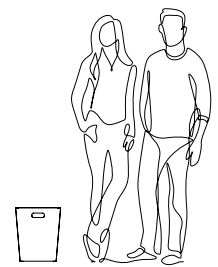

BIN EQUIPPED WITH A HANDLE AND LID + BIN BAG HOLDER

CHARACTERISTICS	CARACTERÍSTICAS	CARACTÉRISTIQUES	CARATTERISTICHE
Bin made of 1.5 mm sheet iron. Body welded together. Removable lid with independent inner rings made of metal rods for inserting waste bags. Epoxy paint in the desired color. The base incorporates 4 rubber pieces to protect the surface in which it is placed. Optional waste indicator in adhesive vinyl.	Papelera fabricada en chapa de hierro de 1,5 mm. Cuerpo unido mediante soldadura. Tapa extraíble con aro interior independiente de varilla metálica para incorporación de bolsa para los residuos. Pintura epoxi del color deseado. La base incorpora 4 piezas de goma para proteger la superficie donde se ubique. Opcional icono indicador de residuo en vinilo.	<i>Corbeille fabriquée en tôle de fer de 1,5 mm. Corps assemblé par soudure. Couvercle amovible avec un anneau intérieur indépendant en tige métallique pour maintenir les sacs en plastique. Peinture époxy de la couleur souhaitée. La base intègre 4 pièces en caoutchouc pour protéger la surface où elle est placée. Option de indicateur de recyclage en vinyle adhésif.</i>	<i>Cestino realizzato in lamiera di ferro di 1,5 mm. Corpo unito mediante saldatura. Coperchio rimovibile con anello interno indipendente in barra metallica per l'inserimento di un sacchetto per i rifiuti. Verniciatura epossidica del colore desiderato. La base incorpora 4 pezzi di gomma per proteggere la superficie su cui è posato. Indicatore di rifiuto in vinile adesivo opzionale.</i>

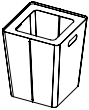





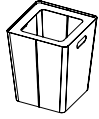









REF	↕↔	
 <b>WIN 01</b>	25 x 25 x 30 cm — 14,2 L 9,8 x 9,8 x 11,8 in. — 3,7 gal.	3,1 kg 6,8 lb.

ENVIRONMENTAL IMPACT				FIRE RESISTANCE	RÉSISTANCE AU FEU
				RESISTENCIA AL FUEGO	RESISTENZA AL FUOCO
Materials may be easily disassembled to be recycled.	Materiales fácilmente segregables para su posterior reciclado.	<i>Matériaux facilement démontables pour leurs recyclages.</i>	<i>Materiali facilmente separabile per un successivo riciclaggio.</i>	UNE-EN 13501-1	A1-s1, d0

WARRANTY	GARANTIA	GARANTIE	GARANZIA	PACKAGING	EMBALAJE	EMBALLAGE	IMBALLAGGIO
Two (2) year limited warranty. Does not cover: incorrect use, bad handling or deliberate damage.	Garantía de dos (2) años limitada. No cubre: mal uso, manipulación o daños intencionados.	<i>Garantie deux (2) ans. À l'exception: mauvaise utilisation, manipulation, dommages intentionnés.</i>	<i>Due (2) anni di garanzie limitati. Non copre: uso improprio, manipolazione o danno intenzionale.</i>	Cardboard box with plastic bag for product protection. One package.	Caja de cartón con bolsa de plástico para protección. Un paquete.	<i>Boîte en carton avec sac plastique pour la protection. Un paquet.</i>	<i>Scatola di cartone con sacchetto di plastica per protezione. Un pacco.</i>



BRAND COLORS





 BL · Ral 9003	 VD · Ral 6000
 CE · Ral 7033	 PE · Ral 5020
 GR · Ral 7015	 AZ · Ral 5009
 AN · Ral 7016	 BD · Ral 3005
 MA · Ral 8014	 RJ · Ral 3020
 OP · Ral 1036	 RS · Ral 2012
 VF · Ral 6020	 AM · Ral 1007
 VO · Ral 6011	 NJ · Ral 2017

CUSTOMIZE OPTIONS

OPCIONES PERSONALIZADAS

PERSONNALISER LES OPTIONS











OPZIONI DI PERSONALIZZAZIONE

 RAL COLOR	 TRASH BAG
 HEIGHT & WIDTH	 PICTOGRAMS

TRASH BAG

 BAG 01	54 x 60 cm 21,3 x 23,6 in.
---	-------------------------------

LABELS

Thickness  1,5 mm	Acoustic  Doesn't absorb sound
Material  Iron	Fire resistance  UNE-EN 13501-1 A1-51,dø
Finish  Painting	Optimal Space  Indoor
Conductivity  100% *iron	Cleaning  Water & Drying
Volume  14,2 L / 3,7 gal	Weight  3,1 kg / 6,8 lb. unit



# Friburg

by Rono

**Metal waste bin collection for two types of waste, designed for shortstay coliving spaces. Hotels, hostels, aparthotels, rental apartments... Ideal for small-scale recycling in clean spaces. Available in 16 colors.**

Colección de papelerera metálica de dos residuos pensada para espacios de coliving de corta estancia. Hoteles, albergues, apartahoteles, pisos de alquiler... Ideal para reciclar a pequeña escala en espacios limpios. Disponible en 16 colores.

*Collection de poubelles métalliques pour deux types de déchets, conçue pour les espaces de coliving de courte durée. Hôtels, auberges, appart'hôtels, appartements en location... Idéale pour le recyclage à petite échelle dans des espaces propres. Disponible en 16 couleurs.*

Collezione di cestini metallici per due tipi di rifiuti, pensata per spazi di coliving di breve durata. Hotel, ostelli, aparthotel, appartamenti in affitto... Ideale per il riciclaggio su piccola scala in spazi puliti. Disponibile in 16 colori.









# More about Friburg

DESIGNER

Rono

YEAR

2024

LINE SKETCH

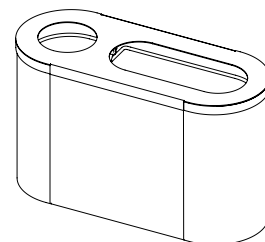

SCALE 1:10 (cm)

PRODUCT

REFERENCE

SIZE



**FRI 01**

50 x 30 x 20 cm — 26,3 L  
19,7 x 11,8 x 7,8 in. — 6,9 gal



BIN LID DETAIL



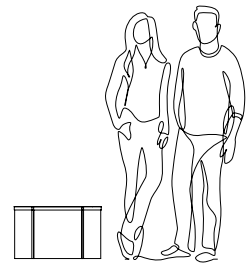

BIN BAG HOLDERS DETAILS





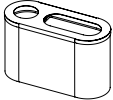



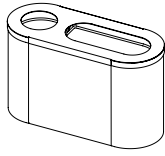









RANGE OF COLOR

CHARACTERISTICS	CARACTERÍSTICAS	CARACTÉRISTIQUES	CARATTERISTICHE
Bin made of 1.5 mm sheet iron. Body welded together. Removable lid with independent inner rings made of metal rods for inserting waste bags. Epoxy paint in the desired color. The base incorporates 4 rubber pieces to protect the surface in which it is placed. Optional waste indicator in adhesive vinyl.	Papelera fabricada en chapa de hierro de 1,5 mm. Cuerpo unido mediante soldadura. Tapa extraíble con aros interiores independientes de varilla metálica, para incorporación de bolsas para los residuos. Pintura epoxi del color deseado. La base incorpora 4 piezas de goma para proteger la superficie donde se ubique. Opcional icono indicador de residuo en vinilo.	<i>Corbeille fabriquée en tôle de fer de 1,5mm. Corps assemblé par soudure. Couvercle amovible avec des anneaux intérieurs indépendants en tige métallique pour maintenir les sacs en plastique. Peinture époxy de la couleur souhaitée. La base intègre 4 pièces en caoutchouc pour protéger la surface où elle est placée. Option de indicateur de recyclage en vinyle adhésif.</i>	<i>Cestino realizzato in lamiera di ferro di 1,5 mm. Corpo unito mediante saldatura. Coperchio rimovibile con anelli interni indipendenti in barra metallica per l'inserimento di sacchetti per i rifiuti. Verniciatura epossidica del colore desiderato. La base incorpora 4 pezzi di gomma per proteggere la superficie su cui è posato. Indicatore di rifiuto in vinile adesivo opzionale.</i>
REF	↕↔		
 <b>FRI 01</b>	50 x 30 x 20 cm — 26,3 L 19,7 x 11,8 x 7,8 in. — 6,9 gal	6,8 kg 15 lb.	

ENVIRONMENTAL IMPACT				FIRE RESISTANCE	RÉSISTANCE AU FEU		
				RESISTENCIA AL FUEGO	RESISTENZA AL FUOCO		
Materials may be easily disassembled to be recycled.	Materiales fácilmente segregables para su posterior reciclado.	<i>Matériaux facilement démontables pour leurs recyclages.</i>	<i>Materiali facilmente separabile per un successivo riciclaggio.</i>	UNE-EN 13501-1	A1-s1, d0		
WARRANTY	GARANTIA	GARANTIE	GARANZIA	PACKAGING	EMBALAJE	EMBALLAGE	IMBALLAGGIO
Two (2) year limited warranty. Does not cover: incorrect use, bad handling or deliberate damage.	Garantía de dos (2) años limitada. No cubre: mal uso, manipulación o daños intencionados.	<i>Garantie deux (2) ans. À l'exception: mauvaise utilisation, manipulation, dommages intentionnés.</i>	<i>Due (2) anni di garanzie limitati. Non copre: uso improprio, manipolazione o danno intenzionale.</i>	Cardboard box with plastic bag for product protection. One package.	Caja de cartón con bolsa de plástico para protección. Un paquete.	<i>Boîte en carton avec sac plastique pour la protection. Un paquet.</i>	<i>Scatola di cartone con sacchetto di plastica per protezione. Un pacco.</i>



BRAND COLORS





 BL · Ral 9003	 VD · Ral 6000
 CE · Ral 7033	 PE · Ral 5020
 GR · Ral 7015	 AZ · Ral 5009
 AN · Ral 7016	 BD · Ral 3005
 MA · Ral 8014	 RJ · Ral 3020
 OP · Ral 1036	 RS · Ral 2012
 VF · Ral 6020	 AM · Ral 1007
 VO · Ral 6011	 NJ · Ral 2017

CUSTOMIZE OPTIONS

OPCIONES PERSONALIZADAS

PERSONNALISER LES OPTIONS











OPZIONI DI PERSONALIZZAZIONE

 RAL COLOR	 TRASH BAG
 HEIGHT & WIDTH	 PICTOGRAMS

TRASH BAG

 BAG 01	54 x 60 cm 21,3 x 23,6 in.
---	-------------------------------

LABELS

Thickness  1,5 mm	Acoustic  Doesn't absorb sound
Material  Iron	Fire resistance  UNE-EN 13501-1 A1-51,d0
Finish  Painting	Optimal Space  Indoor
Conductivity  100% *iron	Cleaning  Water & Drying
Volume  26,3 L / 6,9 gal	Weight  6,8 kg / 15 lb. unit



# Lugano

by CrousCalogero

Imagine not having to bend over to dispose of waste. We have raised the bin to table height. A great idea, so that in large offices the bin can be emptied effortlessly by the cleaning team.

Imagina no tener que agacharte para dejar algo en la papelera. Hemos elevado la papelera a la altura de la mesa, pero sin que moleste. Una idea genial, incluso para que en oficinas grandes el vaciado no pase factura al personal de limpieza. Y además, ¡es divertida!

*Imaginez ne pas avoir à vous pencher pour laisser quelque chose à la poubelle. Nous avons élevé le bac à la hauteur de la table, mais sans qu'il nous gêne. Une idée géniale, qui facilitera le travail du personnel de nettoyage dans les grands espaces de bureaux. En plus elle est amusante !*

**Imagina di non doverti piegare per mettere qualcosa nella spazzatura. Abbiamo alzato il bidone al altezza del tavolo, ma senza disturbare. Un'idea fantastica, anche per i grandi uffici dove il personale delle pulizie non dovrà perdere tempo a svuotarli.**









# More about Lugano

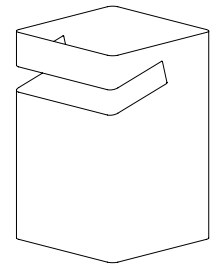

SCALE 1:10 (cm)

DESIGNER

CrousCalogero

YEAR

2014

LINE SKETCH

PRODUCT

REFERENCE

SIZE



**LUG 01**

18,8 x 18,8 x 30 cm — 8 L  
7,4 x 7,4 x 11,8 in. — 2,1 gal.



DESK FIXING DETAIL — LUG 01



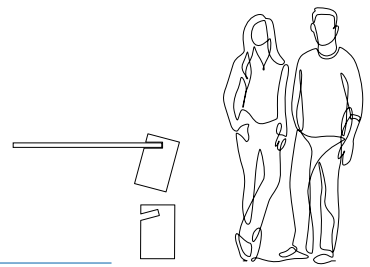

SUITABLE FOR DESKS UP TO 35 MM THICKNESS — LUG 01



MINI-BIN DETAIL — LUG 01



# Lugano

by CrousCalogero

← VIEW PRODUCT PAGES

138

CHARACTERISTICS	CARACTERÍSTICAS	CARACTÉRISTIQUES	CARATTERISTICHE
Bin made from 1.2 mm sheet metal. The base and body of the bin unified by welding. Base includes rubber blocks to protect the surface where it is located. Includes protective rubber on the front opening of 35 mm to protect the surface where it hangs.	Papelera fabricada en chapa de hierro de 1,2 mm. Unión de la base con el cuerpo de la papelera mediante soldadura. Base con tacos de goma para proteger la superficie donde se ubique. Incluye goma protectora en la apertura frontal de 35 mm para proteger la superficie donde se encaja.	Corbeille fabriquée en tôle de 1,2 mm d'épaisseur. Union de la base et du corps de la corbeille soudé. Base avec des gommages de caoutchouc pour protéger la surface où elle se trouve. Comprend un caoutchouc de protection sur l'ouverture frontale de 35 mm d'épaisseur pour protéger la superficie où elle se trouvera.	Cestino in lamiera ferro da 1,2 mm. Unione del base con corpo del cestino mediante saldatura. Base con borchie in gomma per proteggere il superficie dove si trova. Include gomma protettiva sull'apertura frontale da 35mm per proteggere la superficie dove pende.







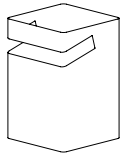









	REF	↕↔	
	<b>LUG 01</b>	18,8 x 18,8 x 30 cm — 8 L 7,4 x 7,4 x 11,8 in. — 2,1 gal.	4 kg 8,8 lb.

ENVIRONMENTAL IMPACT				FIRE RESISTANCE	RÉSISTANCE AU FEU
				RESISTENCIA AL FUEGO	RESISTENZA AL FUOCO
Materials may be easily disassembled to be recycled.	Materiales fácilmente segregables para su posterior reciclado.	Matériaux facilement démontables pour leurs recyclages.	Materiali facilmente separabile per un successivo riciclaggio.	UNE-EN 13501-1	A1-s1, d0

WARRANTY	GARANTIA	GARANTIE	GARANZIA	PACKAGING	EMBALAJE	EMBALLAGE	IMBALLAGGIO
Two (2) year limited warranty. Does not cover: incorrect use, bad handling or deliberate damage.	Garantía de dos (2) años limitada. No cubre: mal uso, manipulación o daños intencionados.	Garantie deux (2) ans. À l'exception: mauvaise utilisation, manipulation, dommages intentionnés.	Due (2) anni di garanzie limitati. Non copre: uso improprio, manipolazione o danno intenzionale.	Cardboard box with plastic bag for product protection. One package.	Caja de cartón con bolsa de plástico para protección. Un paquete.	Boîte en carton avec sac plastique pour la protection. Un paquet.	Scatola di cartone con sacchetto di plastica per protezione. Un pacco.



BRAND COLORS





 BL · Ral 9003	 VD · Ral 6000
 CE · Ral 7033	 PE · Ral 5020
 GR · Ral 7015	 AZ · Ral 5009
 AN · Ral 7016	 BD · Ral 3005
 MA · Ral 8014	 RJ · Ral 3020
 OP · Ral 1036	 RS · Ral 2012
 VF · Ral 6020	 AM · Ral 1007
 VO · Ral 6011	 NJ · Ral 2017

CUSTOMIZE OPTIONS

OPCIONES PERSONALIZADAS

PERSONNALISER LES OPTIONS











OPZIONI DI PERSONALIZZAZIONE

 RAL COLOR	 TRASH BAG
 HEIGHT & WIDTH	 PICTOGRAMS

TRASH BAG

 BAG 01	54 x 60 cm 21,3 x 23,6 in.
---	-------------------------------

LABELS

Thickness  1,5 mm	Acoustic  Doesn't absorb sound
Material  Iron	Fire resistance  UNE-EN 13501-1 A1-51,d0
Finish  Painting	Optimal Space  Indoor
Conductivity  100% *iron	Cleaning  Water & Drying
Volume  8 L / 2,1 gal	Weight  4 kg / 8,8 lb. unit



# Laax

by Stone Designs

**This outdoor ashtray will modernise the rest areas of any exterior or interior patio. Manufactured in epoxy painted iron and treated with cataphoresis, it will resist any inclemency in the weather. It's very simple and easy to clean.**

Este cenicero modernizará las zonas de descanso exterior de un edificio o una gran superficie. Fabricado en hierro pintado epoxi y tratado con cataforesis, resistirá a la intemperie a cualquier inclemencia del tiempo. Además, tiene un sistema de vaciado y limpieza muy simple.

*Ce cendrier modernisera les aires de repos extérieures d'un bâtiment ou d'une grande surface. Fabriqué en fer peint à l'époxy et traité par cataphorèse, il résistera aux inclémences de toutes les intempéries. De plus, il dispose d'un système de vidange et de nettoyage très simple.*

**Questo posacenere modernizzerà le aree di sosta esterne di un edificio o di una vasta area. Fatto di ferro verniciato epossidico e trattato con la cataforesi, resisterà al tempo e alle intemperie. Inoltre, ha un sistema di svuotamento e pulizia molto semplice.**









# More about Laax

DESIGNER

Stone Designs

YEAR

2016

LINE SKETCH

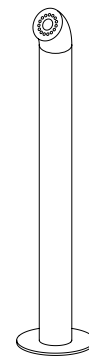

SCALE 1:20 (cm)

PRODUCT

REFERENCE

SIZE



LAX 01

Ø 21 x 100 cm - 0,70 L  
Ø 8,3 x 39,4 in. - 0,18 gal.

Tube: Ø 8,8 cm / Ø 3,4 in.



ASHTRAY TOP REMOVABLE – LAX 01





DETAIL OF UPPER LID – LAX 01 + 9006

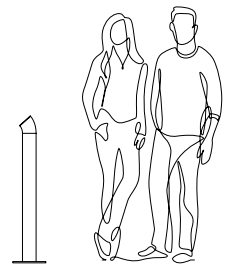



LAAX FAMILY

CHARACTERISTICS	CARACTERÍSTICAS	CARACTÉRISTIQUES	CARATTERISTICHE
Ashtray made of 3.2mm thick iron tube. Removable head for emptying ashes. The head is fixed to the body using an allen key included. Fixed to floor using screws. The mouth of the ashtray is made from stainless steel.	Cenicero fabricado en tubo de hierro de 3,2 mm de grosor. Cabezal extraíble para el vaciado de la cubeta interior. El cabezal se fija al cuerpo mediante llave allen incluida. Fijación a suelo mediante tornillos. La boca del cenicero fabricada en chapa de acero inoxidable.	<i>Cendrier en tube de fer de 3,2 mm d'épaisseur. Partie supérieure amovible pour vider le bac intérieur. La partie supérieure est fixée au corps avec une clé Allen incluse. Fixation au sol avec des vis. L'orifice du cendrier est fabriqué en tôle d'acier inoxydable.</i>	<i>Posacenere in tubo Ferro da 3,2 mm di spessore. Parte superiore estraibile per svuotare il secchio interno. La testa è fissata al corpo con chiave allen inclusa. Fissaggio a terra con viti. La bocca del posacenere fabbricato in lamiera di acciaio inox.</i>

















REF	↕↔	
 <b>LAX 01</b>	Ø 21 x 100 cm - 0,70 L Ø 8,3 x 39,4 in. - 0,18 gal.  Tube: Ø 8,8 cm / Ø 3,4 in.	8 kg 17,6 lb.

ENVIRONMENTAL IMPACT				FIRE RESISTANCE	RÉSISTANCE AU FEU
				RESISTENCIA AL FUEGO	RESISTENZA AL FUOCO
Materials may be easily disassembled to be recycled.	Materiales fácilmente segregables para su posterior reciclado.	<i>Matériaux facilement démontables pour leurs recyclages.</i>	<i>Materiali facilmente separabile per un successivo riciclaggio.</i>	UNE-EN 13501-1	A1-s1, d0

WARRANTY	GARANTIA	GARANTIE	GARANZIA	PACKAGING	EMBALAJE	EMBALLAGE	IMBALLAGGIO
Two (2) year limited warranty. Does not cover: incorrect use, bad handling or deliberate damage.	Garantía de dos (2) años limitada. No cubre: mal uso, manipulación o daños intencionados.	<i>Garantie deux (2) ans. À l'exception: mauvaise utilisation, manipulation, dommages intentionnés.</i>	<i>Due (2) anni di garanzie limitati. Non copre: uso improprio, manipolazione o danno intenzionale.</i>	Cardboard box with plastic bag for product protection. One package.	Caja de cartón con bolsa de plástico para protección. Un paquete.	<i>Boîte en carton avec sac plastique pour la protection. Un paquet.</i>	<i>Scatola di cartone con sacchetto di plastica per protezione. Un pacco.</i>



BRAND COLORS











 BL · Ral 9003	 VD · Ral 6000
 CE · Ral 7033	 PE · Ral 5020
 GR · Ral 7015	 AZ · Ral 5009
 AN · Ral 7016	 BD · Ral 3005
 MA · Ral 8014	 RJ · Ral 3020
 OP · Ral 1036	 RS · Ral 2012
 VF · Ral 6020	 AM · Ral 1007
 VO · Ral 6011	 NJ · Ral 2017

CUSTOMIZE OPTIONS  
OPCIONES PERSONALIZADAS

PERSONNALISER LES OPTIONS  
OPZIONI DI PERSONALIZZAZIONE

-  RAL COLOR
-  PICTOGRAMS
-  HEIGHT & WIDTH

LABELS

Thickness  1,5 mm	Acoustic  Doesn't absorb sound
Material  Iron	Fire resistance  UNE-EN 13501-1 A1-51,d0
Finish  Painting	Optimal Space  Indoor / Outdoor
Conductivity  100% iron	Cleaning  Water & Drying
	Weight  8 kg / 17,6 lb. unit



---

# Planters

02

---

---

<b>156</b>	Naka
<b>164</b>	Nipori
<b>172</b>	Kyoto
<b>180</b>	Nyon Plt

# Naka

by Gauzak

This special space divider in the shape of a planter allows it to be located in a friendly and fun way in any space, both indoors and outdoors. Separating, distancing and creating cozy areas in a subtle way are its main characteristics. You can sow natural and artificial plants or huge metallic or recycled PET leaves with sound-absorbing properties.

*Ce séparateur de pièce en forme de jardinière peut être placé de manière conviviale et amusante dans n'importe quel espace intérieur ou extérieur. Sa principale caractéristique est de séparer, d'éloigner et de créer des espaces agréables de manière subtile. Vous pouvez y planter des plantes naturelles ou artificielles ou d'immenses feuilles en métal ou en PET recyclé aux propriétés insonorisantes.*

Este particular separador de espacios con forma de jardinera, permite ubicarse de manera simpática y divertida en cualquier espacio tanto interior como exterior. Separar, distanciar y crear espacios acogedores de manera sutil es su principal característica. Puedes sembrar plantas naturales y artificiales o unas enormes hojas metálicas o de PET reciclado con propiedades fonoabsorbentes.

Questo particolare divisorio a forma di fioriera può essere collocato in modo simpatico e divertente in qualsiasi spazio interno o esterno. La sua caratteristica principale è quella di separare, distanziare e creare spazi accoglienti in modo discreto. Si possono piantare piante naturali e artificiali o enormi foglie di metallo o PET riciclato con proprietà fonoassorbenti.











# More about Naka

DESIGNER

Gauzak

YEAR

2023

LINE SKETCH

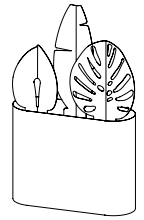

SCALE 1:20 (cm)

PRODUCT

REFERENCE

SIZE



**NAK 01**

\*FOR METALLIC  
OR PET LEAVES

102 x 35 x 40 cm  
40,1 x 13,7 x 15,7 in



**NAK 02**

\*FOR METALLIC  
OR PET LEAVES

102 x 35 x 70 cm  
40,1 x 13,7 x 27,5 in



**NAK 05**

\*FOR PLANTS

102 x 35 x 40 cm  
40,1 x 13,7 x 15,7 in



**NAK 07**

\*FOR PLANTS

102 x 35 x 70 cm  
40,1 x 13,7 x 27,5 in

PRODUCT

REFERENCE

SIZE



**NAK 10** \*METAL

66 x 38 cm

**NAK 20** \*PET

25,9 x 14,9 in



**NAK 11** \*METAL

101 x 34 cm

**NAK 21** \*PET

39,7 x 13,3 in



**NAK 12** \*METAL

77 x 55,5 cm

**NAK 22** \*PET

30,3 x 21,8 in



METAL LEAVES / LEAVES IN PET MATERIAL



PLANTER

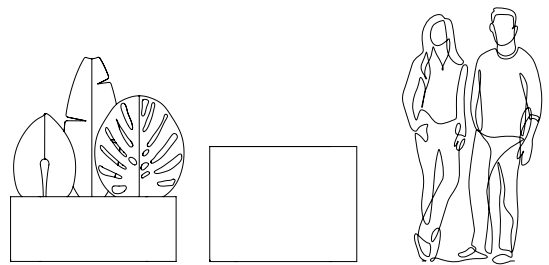

2 PLANTERS / 40 CM & 80 CM



RANGE COLORS / METALLIC & PET







# Naka

by Gauzak

← VIEW PRODUCT PAGES

156

CHARACTERISTICS	CARACTERÍSTICAS	CARACTÉRISTIQUES	CARATTERISTICHE
Planter made of 1.5 mm thick sheet iron, available in two heights of 40 and 60 cm. It has three different models of leaves, screwed to a 4 mm thick handrail, where their position can be randomly combined. The top cover is removable for cleaning. The planter is also available for natural plants.	Jardinera fabricada en chapa de hierro de 1,5 mm de grosor, disponible en dos alturas de 40 y 60 cm. Dispone de tres modelos distintos de hojas, atornilladas a un pasamano de 4 mm de grosor, donde se pueden combinar su posición aleatoriamente. La tapa superior es extraíble para limpiar. La jardinera también se encuentra disponible para planta natural.	Jardinière en tôle de fer de 1,5 mm d'épaisseur, disponible en deux hauteurs, 40 et 60 cm. Elle possède trois modèles différents de feuilles, vissées à une main courante de 4 mm d'épaisseur, dont la position peut être combinée de manière aléatoire. Le couvercle est amovible pour le nettoyage. La jardinière est également disponible pour les plantes naturelles.	Fioriera in lamiera di ferro di 1,5 mm di spessore, disponibile in due altezze di 40 e 60 cm. È dotata di tre diversi modelli di foglie, avvitate a un corrimano di 4 mm di spessore, la cui posizione può essere combinata in modo casuale. Il coperchio superiore è rimovibile per la pulizia. La fioriera è disponibile anche per piante naturali.







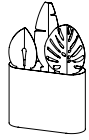









REF	↕↔	📏	REF	↕↔	📏
 <b>NAK 01</b> *FOR METALLIC OR PET LEAVES	102 x 35 x 40 cm 40,1 x 13,7 x 15,7 in.	25,4 kg 55,99 lb.	 <b>NAK 10</b> *METAL <b>NAK 20</b> *PET	66 x 38 cm 25,9 x 14,9 in	2,1 kg (*METAL) 4,6 lb (*METAL) 0,320 kg (*PET) 0,7 lb (*PET)
 <b>NAK 02</b> *FOR METALLIC OR PET LEAVES	102 x 35 x 60 cm 40,1 x 13,7 x 23,6 in.	38,8 kg 85,53 lb.	 <b>NAK 11</b> *METAL <b>NAK 21</b> *PET	101 x 34 cm 39,7 x 13,3 in	3,2 kg (*METAL) 7 lb (*METAL) 0,480 kg (*PET) 1,05 lb (*PET)
 <b>NAK 05</b> *FOR PLANTS	102 x 35 x 40 cm 40,1 x 13,7 x 15,7 in.	20,75 kg 45,74 lb.	 <b>NAK 12</b> *METAL <b>NAK 22</b> *PET	77 x 55,5 cm 30,3 x 21,8 in	3,1 kg (*METAL) 6,8 lb (*METAL) 0,450 kg (*PET) 0,99 lb (*PET)
 <b>NAK 07</b> *FOR PLANTS	102 x 35 x 60 cm 40,1 x 13,7 x 23,6 in.	34,15 kg 75,28 lb.			

ENVIRONMENTAL IMPACT				FIRE RESISTANCE	RÉSISTANCE AU FEU
				RESISTENCIA AL FUEGO	RESISTENZA AL FUOCO
Materials may be easily disassembled to be recycled.	Materiales fácilmente segregables para su posterior reciclado.	Matériaux facilement démontables pour leurs recyclages.	Materiali facilmente separabile per un successivo riciclaggio.	UNE-EN 13501-1	A1-s1, d0

WARRANTY	GARANTIA	GARANTIE	GARANZIA	PACKAGING	EMBALAJE	EMBALLAGE	IMBALLAGGIO
Two (2) year limited warranty. Does not cover: incorrect use, bad handling or deliberate damage.	Garantía de dos (2) años limitada. No cubre: mal uso, manipulación o daños intencionados.	Garantie deux (2) ans. À l'exception: mauvaise utilisation, manipulation, dommages intentionnés.	Due (2) anni di garanzie limitati. Non copre: uso improprio, manipolazione o danno intenzionale.	Cardboard box with plastic bag for product protection. One package.	Caja de cartón con bolsa de plástico para protección. Un paquete.	Boîte en carton avec sac plastique pour la protection. Un paquet.	Scatola di cartone con sacchetto di plastica per protezione. Un pacco.



BRAND COLORS

 BL · Ral 9003	 VD · Ral 6000
 CE · Ral 7033	 PE · Ral 5020
 GR · Ral 7015	 AZ · Ral 5009
 AN · Ral 7016	 BD · Ral 3005
 MA · Ral 8014	 RJ · Ral 3020
 OP · Ral 1036	 RS · Ral 2012
 VF · Ral 6020	 AM · Ral 1007
 VO · Ral 6011	 NJ · Ral 2017

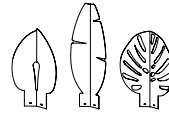

PET COLORS

 BO-00	 AM - 90
 GM- 08	 IL - 18
 GM - 92	 NR - 09
 GS - 96	 RO - 60
 NO - 00	 RS - 31
 BE - 07	 RS - 67
 BE - 32	 VR - 07
 AZ - 05	 VR - 11
 AZ - 25	 VR - 25

CUSTOMIZE OPTIONS

OPCIONES PERSONALIZADAS

PERSONNALISER LES OPTIONS

OPZIONI DI PERSONALIZZAZIONE





LABELS

Thickness  1,5 mm

Material  Iron

Finish  Painting

Conductivity  100%

Acoustic  Doesn't absorb sound

Fire resistance  UNE-EN 13501-1 A1-s1, d0

Optimal Space  Indoor

Cleaning  Water & Drying

Weight  See page 350



# Nipori

by Stone Designs

**Concave or convex. What has been the planter of a lifetime... plus an inverted version. Made of lacquered sheet metal in 16 available colours, it is ideal for setting up areas in indoor or outdoor spaces. S, M, L and XL are its 4 sizes so that you can place them as best suits your space.**

Cóncava o convexa. Lo que viene siendo la maceta de toda la vida... más una versión invertida. Fabricada en chapa metálica lacada con 16 colores disponibles, es ideal para configurar áreas en espacios interiores o exteriores. S, M, L y XL son sus 4 tallas para que las ubiques como mejor le siente a tu espacio.

*Concave ou convexe. Ce qui a été le bac à plantes de toute une vie... plus une version inversée. Réalisé en tôle laquée en 16 couleurs disponibles, il est idéal pour aménager des espaces à l'intérieur ou à l'extérieur. S, M, L et XL sont ses 4 tailles pour que vous puissiez les placer au mieux dans votre espace.*

**Concavo o convesso. Quella che è stata la fioriera di una vita... più una versione rovesciata. Realizzata in lamiera laccata in 16 colori disponibili, è ideale per allestire aree in spazi interni o esterni. S, M, L e XL sono le sue 4 misure, in modo da poterle posizionare come meglio si adatta al vostro spazio.**











# More about Nipori

DESIGNER

Stone Designs

YEAR

2023

LINE SKETCH

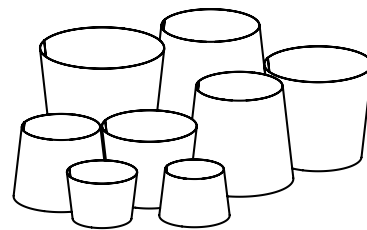

SCALE 1:40 (cm)

PRODUCT

REFERENCE

SIZE

\* CONVEX



**NIP 01 / S**

Ø 43 x 30 cm  
Ø 16,9 x 11,8 in.



**NIP 01 / M**

Ø 58 x 45 cm  
Ø 22,8 x 17,7 in.



**NIP 01 / L**

Ø 66 x 60 cm  
Ø 25,9 x 23,6 in.



**NIP 01 / XL**

Ø 76 x 75 cm  
Ø 29,9 x 29,5 in.

PRODUCT

REFERENCE

SIZE

\* CONCAVE



**NIP 02 / S**

Ø 36 x 30 cm  
Ø 14,1 x 11,8 in.



**NIP 02 / M**

Ø 48 x 45 cm  
Ø 18,8 x 17,7 in.



**NIP 02 / L**

Ø 53 x 60 cm  
Ø 20,8 x 23,6 in.



**NIP 02 / XL**

Ø 60 x 75 cm  
Ø 23,6 x 29,5 in.



METALLIC FINISH / AVAILABLE SIZES

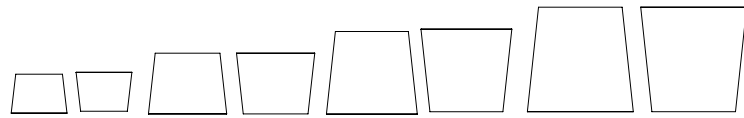
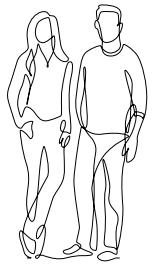











RANGE 16 COLORS

# Nipori

by Stone Designs

← VIEW PRODUCT PAGES

164







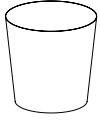









CHARACTERISTICS		CARACTERÍSTICAS		CARACTÉRISTIQUES		CARATTERISTICHE	
Concave and convex planters made of 1.5 mm thick sheet metal in different heights and diameters with a micro-textured lacquered finish.		Jardineras cóncava y convexa de chapa metálica de 1,5 mm de grosor en diferentes alturas y diámetros con un acabado lacado microtexturizado.		Jardinières concaves et convexes en tôle d'acier de 1,5 mm d'épaisseur, de différentes hauteurs et de différents diamètres, avec une finition laquée microtexturée.		Fioriere concave e convesse in lamiera di 1,5 mm di spessore, in diverse altezze e diametri, con finitura laccata microtesturizzata.	
REF	↕↔		REF	↕↔			
* CONVEX 	<b>NIP 01 / S</b>	Ø 43 x 30 cm Ø 16,9 x 11,8 in.	6,1 kg 13,4 lb.	* CONCAVE 	<b>NIP 02 / S</b>	Ø 36 x 30 cm Ø 14,1 x 11,8 in.	7 kg 15,4 lb.
	<b>NIP 01 / M</b>	Ø 58 x 45 cm Ø 22,8 x 17,7 in.	11,8 kg 26 lb.		<b>NIP 02 / M</b>	Ø 48 x 45 cm Ø 18,8 x 17,7 in.	13,2 kg 29,1 lb.
	<b>NIP 01 / L</b>	Ø 66 x 60 cm Ø 25,9 x 23,6 in.	16,7 kg 36,8 lb.		<b>NIP 02 / L</b>	Ø 53 x 60 cm Ø 20,8 x 23,6 in.	18,3 kg 40,3 lb.
	<b>NIP 01 / XL</b>	Ø 76 x 75 cm Ø 29,9 x 29,5 in.	23,4 kg 51,5 lb.		<b>NIP 02 / XL</b>	Ø 60 x 75 cm Ø 23,6 x 29,5 in.	25,9 kg 57 lb.

ENVIRONMENTAL IMPACT				FIRE RESISTANCE	RÉSISTANCE AU FEU
				RESISTENCIA AL FUEGO	RESISTENZA AL FUOCO
Materials may be easily disassembled to be recycled.	Materiales fácilmente segregables para su posterior reciclado.	<i>Matériaux facilement démontables pour leurs recyclages.</i>	<i>Materiali facilmente separabile per un successivo riciclaggio.</i>	UNE-EN 13501-1	A1-s1, d0

WARRANTY	GARANTIA	GARANTIE	GARANZIA	PACKAGING	EMBALAJE	EMBALLAGE	IMBALLAGGIO
Two (2) year limited warranty. Does not cover: incorrect use, bad handling or deliberate damage.	Garantía de dos (2) años limitada. No cubre: mal uso, manipulación o daños intencionados.	<i>Garantie deux (2) ans. À l'exception: mauvaise utilisation, manipulation, dommages intentionnés.</i>	<i>Due (2) anni di garanzie limitati. Non copre: uso improprio, manipolazione o danno intenzionale.</i>	Cardboard box with plastic bag for product protection. One package.	Caja de cartón con bolsa de plástico para protección. Un paquete.	<i>Boîte en carton avec sac plastique pour la protection. Un paquet.</i>	<i>Scatola di cartone con sacchetto di plastica per protezione. Un pacco.</i>



BRAND COLORS

- |  |   |
|--|---|
|  BL · Ral 9003 |  VD · Ral 6000 |
|  CE · Ral 7033 |  PE · Ral 5020 |
|  GR · Ral 7015 |  AZ · Ral 5009 |
|  AN · Ral 7016 |  BD · Ral 3005 |
|  MA · Ral 8014 |  RJ · Ral 3020 |
|  OP · Ral 1036 |  RS · Ral 2012 |
|  VF · Ral 6020 |  AM · Ral 1007 |
|  VO · Ral 6011 |  NJ · Ral 2017 |









CUSTOMIZE OPTIONS      PERSONNALISER LES OPTIONS  
 OPCIONES PERSONALIZADAS      OPZIONI DI PERSONALIZZAZIONE

 RAL COLOR

 PLANTS



LABELS

- |   |  |
|---|--|
| Thickness  1,5 mm  | Acoustic  Doesn't absorb sound            |
| Material  Iron     | Fire resistance  UNE-EN 13501-1 A1-s1, d0 |
| Finish  Lacquered  | Optimal Space  Indoor / Outdoor           |
| Conductivity  100% | Cleaning  Water & Drying                  |
|   | Weight  See page 358                      |

# Kyoto

---

by Joan Gaspar

**An indoor planter that will enhance any interior with a self-watering system in case you forget to water the plants. Available in two sizes and five colours.**

Una jardinera de interior que le dará frescura a tu espacio. Con un sistema de autorriego por si eres de los que se te olvida regar las plantas. Disponible en dos alturas y cinco colores.

*Une jardinière d'intérieur qui donnera de la fraîcheur à votre espace. Avec un système d'auto-arrosage pour si vous êtes de ceux qui oublie d'arroser les plantes. Disponible en deux hauteurs et cinq couleurs.*

**Una fioriera da interni che darà freschezza al tuo spazio. Con un sistema di autoirrigazione nel caso tu fossi uno di quelli che ti dimentichi di annaffiare le piante. Disponibile in due altezze e cinque colori.**











# More about Kyoto

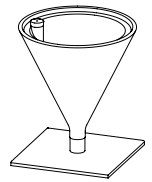

SCALE 1:40 (cm)

DESIGNER

Joan Gaspar

YEAR

2005

LINE SKETCH

PRODUCT

REFERENCE

SIZE

\* CONVEX



**KYT 01**

Ø 39,6 x 44 cm  
Ø 15,6 x 17,3 in.



**KYT 02**

Ø 39,6 x 57 cm  
Ø 15,6 x 22,4 in.



BASES AND SIZE DETAIL

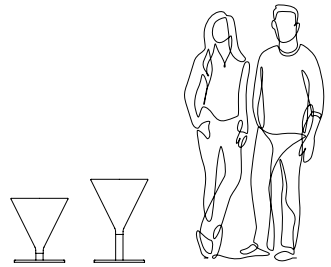

KYOTO SET



SELF-WATERING SYSTEM

# Kyoto

by Joan Gaspar

← VIEW PRODUCT PAGES

172

## CHARACTERISTICS

Polyethylene planter made with roto-moulding. Stainless steel post and base. Interior of planter holds water and functions as a water tank. Regulation of the water passage by means of a ceramic piece at the base. Tank cap in anodized aluminium. Base with rubber studs to protect the surface where it is located.

## CARACTERÍSTICAS



Jardinera de polietileno fabricada por roto-moldeo. Base y tubo de acero inoxidable. Interior de la jardinera vacío, que hace la función de depósito de agua. Regulación del paso de agua mediante una pieza cerámica en la base. Tapón del depósito en aluminio anodizado. Base con tacos de goma para proteger la superficie donde se ubique.

## CARACTÉRISTIQUES

Jardinière en polyéthylène fabriquée par rotomoulage. Base et tube en acier inoxydable. Intérieur de la jardinière vide, qui sert de réservoir d'eau. Régulation du passage de l'eau au travers d'une pièce en céramique dans la base. Bouchon de réservoir en aluminium anodisé. Base avec des gommages de caoutchouc pour protéger la surface où elle se trouve.

## CARATTERISTICHE

Fioriera in polietilene prodotta mediante rotostampaggio. Base e tubo in acciaio inox. L'interno della fioriera è vuoto, che funge da serbatoio dell'acqua. Regolazione del flusso d'acqua attraverso un pezzo in ceramica alla base. Tappo serbatoio in alluminio anodizzato. Base con borchie in gomma per proteggere la superficie dove si trova.

	REF	↕↔	⚖
	<b>KYT 01</b>	Ø 39,6 x 44 cm Ø 15,6 x 17,3 in.	5 kg 11 lb.
	<b>KYT 02</b>	Ø 39,6 x 57 cm Ø 15,6 x 22,4 in.	5,8 kg 12,8 lb.

## ENVIRONMENTAL IMPACT

Materials may be easily disassembled to be recycled.

Materiales fácilmente segregables para su posterior reciclado.

*Matériaux facilement démontables pour leurs recyclages.*

*Materiali facilmente separabile per un successivo riciclaggio.*

## FIRE RESISTANCE

RESISTENCIA AL FUEGO

## RÉSISTANCE AU FEU

RESISTENZA AL FUOCO

UNE-EN 13501-1

B-s1, d1

## WARRANTY

Two (2) year limited warranty. Does not cover: incorrect use, bad handling or deliberate damage.

## GARANTIA

Garantía de dos (2) años limitada. No cubre: mal uso, manipulación o daños intencionados.

## GARANTIE

*Garantie deux (2) ans. À l'exception: mauvaise utilisation, manipulation, dommages intentionnés.*

## GARANZIA

*Due (2) anni di garanzie limitati. Non copre: uso improprio, manipolazione o danno intenzionale.*

## PACKAGING

Cardboard box with plastic bag for product protection. One package.

## EMBALAJE

Caja de cartón con bolsa de plástico para protección. Un paquete.

## EMBALLAGE





*Boîte en carton avec sac plastique pour la protection. Un paquet.*

## IMBALLAGGIO

*Scatola di cartone con sacchetto di plastica per protezione. Un pacco.*







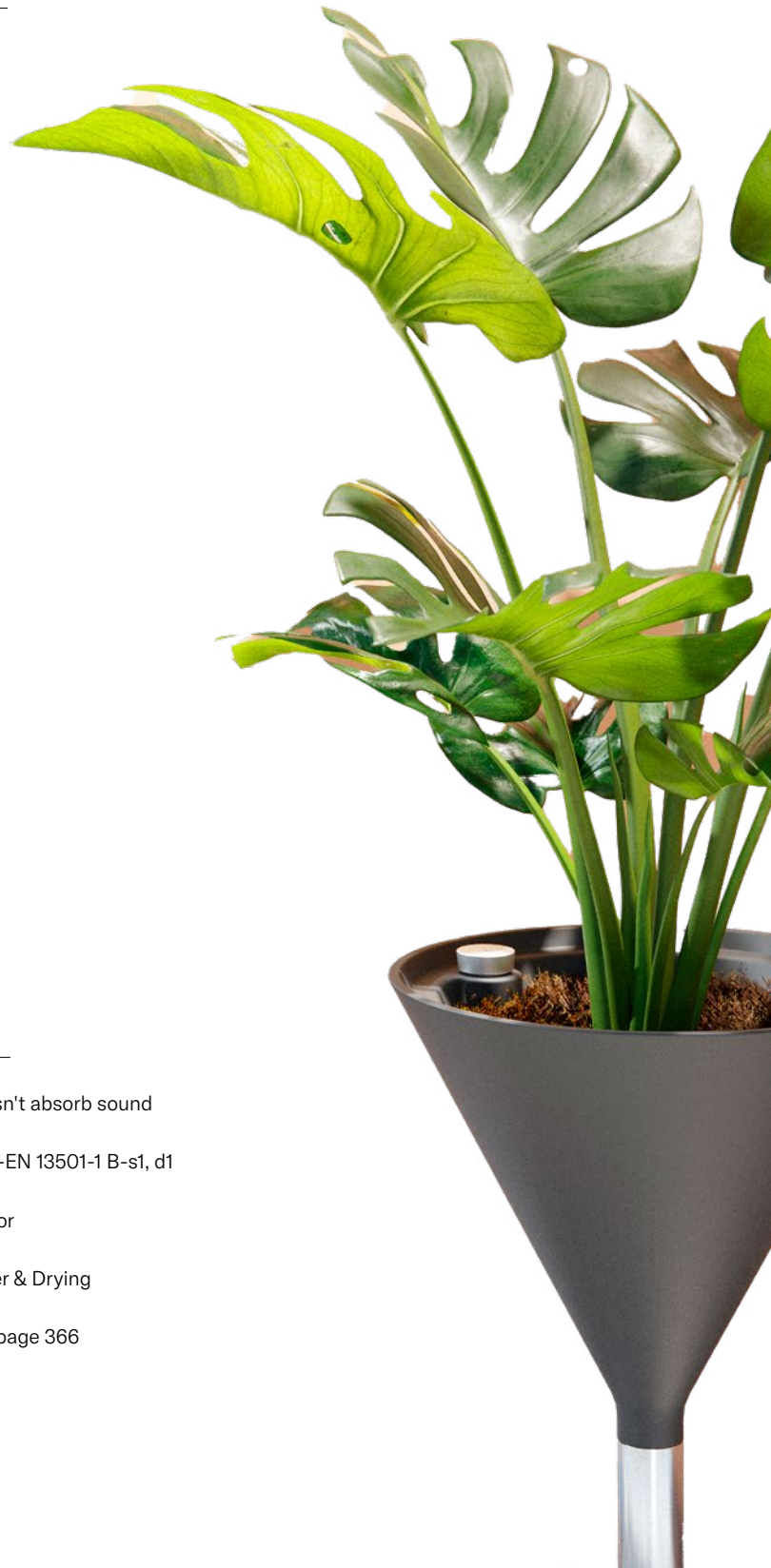



BRAND COLORS

-  BL · Ral 9003
-  MO · Ral 1012
-  TC · Ral 2001
-  AN · Ral 7016
-  NG · Ral 9011



LABELS

Thickness		3 mm	Acoustic		Doesn't absorb sound
Material		Polyethylene	Fire resistance		UNE-EN 13501-1 B-s1, d1
Finish		Base Inox	Optimal Space		Indoor
Conductivity		-	Cleaning		Water & Drying
			Weight		See page 366

# Nyon Plt

by Roger Vancells

**For a space with a good dose of green, we present the metal planter from the Nyon collection. Same finishes as in the range of recycling containers, organic, linear and classic shape, in two sizes and 3 heights in its small version. Available in 16 colors.**

Para un espacio con buena dosis de verde presentamos la Jardinera metálica de la colección Nyon. Mismos acabados que en la gama de contenedores de reciclaje, forma orgánica, linear y clásica, en dos tamaños y 3 alturas en su versión pequeña. Disponible en 16 colores.

*Pour un espace avec une bonne dose de vert, nous vous présentons la jardinière en métal de la collection Nyon. Mêmes finitions que dans la gamme de bacs de recyclage, forme organique, linéaire et classique, en deux tailles et 3 hauteurs dans sa petite version. Disponible en 16 couleurs.*

**Per uno spazio con una buona dose di verde, presentiamo la fioriera in metallo della collezione Nyon. Stesse finiture della gamma di contenitori per il riciclaggio, dalla forma organica, lineare e classica, in due dimensioni e 3 altezze nella sua versione piccola. Disponibile in 16 colori.**











# More about Nyon Plt

DESIGNER

Roger Vancells

YEAR

2024

LINE SKETCH

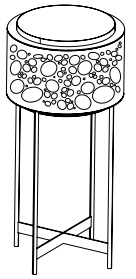

SCALE 1:25 (cm)

PRODUCT

REFERENCE

SIZE

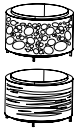

**NYO/PT 10**  
ORGANIC

Ø 60 x 40 cm  
Ø 23,6 x 15,7 in.

**NYO/PT 12**  
LINEAR

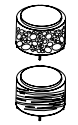

**NYO/PT 20**  
ORGANIC

Ø 42 x 29 cm  
Ø 16,5 x 11,4 in.

**NYO/PT 22**  
LINEAR



**NYO/PT 30**  
ORGANIC

Ø 42 x 65 cm  
Ø 16,5 x 25,6 in.

**NYO/PT 32**  
LINEAR



**NYO/PT 40**  
ORGANIC

Ø 42 x 90 cm  
Ø 16,5 x 35,4 in.

**NYO/PT 42**  
LINEAR



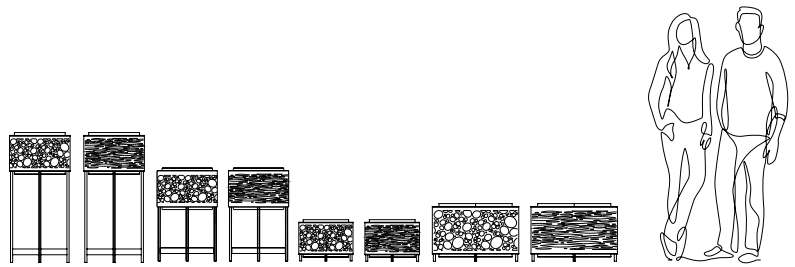





# Nyon Plt

by Roger Vancells

← VIEW PRODUCT PAGES

180

CHARACTERISTICS	CARACTERÍSTICAS	CARACTÉRISTIQUES	CARATTERISTICHE
Planter consisting of two cylinders made of 1.5 mm sheet metal and a 4 mm lid. The outer cylinder is decorative and can be replaced by wooden slats. The base and body of the bin unified by welding. Base supplied with planter blocks to protect the surface where it is located.	Jardinera compuesta de dos cilindros fabricados en chapa de hierro de 1,5 mm y una tapa de hierro de 4 mm. El cilindro exterior es decorativo y puede ser substituido por lamas de madera. Unión de la base con el cuerpo de la jardinera mediante soldadura. Base con tacos de goma para proteger la superficie donde se ubique.	Jardinière composée de deux cylindres en tôle de fer de 1,5 mm et d'un couvercle en fer de 4 mm. Le cylindre extérieur est décoratif et peut être remplacé par des lattes en bois. Union de la base avec le corps de la jardinière par soudure. Base avec patins en caoutchouc pour protéger la surface où elle se trouve.	Fioriera composta da due cilindri in lamiera di ferro da 1,5 mm e coperchio in ferro da 4 mm. Il cilindro esterno è decorativo e può essere sostituito con doghe in legno. Unione della base al corpo della fioriera mediante saldatura. Base con gommini per proteggere la superficie su cui è posizionata.







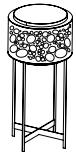









	REF	↕↔	📏
	<b>NYO/PT 10</b> <b>NYO/PT 12</b> <b>NYO/PT 14</b>	Ø 40 x 60 cm Ø 15,7 x 23,6 in.	14,5 kg 32 lb.
	<b>NYO/PT 20</b> <b>NYO/PT 22</b> <b>NYO/PT 24</b>	Ø 29 x 42 cm Ø 11,4 x 16,5 in.	13 kg 28,6 lb.
	<b>NYO/PT 30</b> <b>NYO/PT 32</b> <b>NYO/PT 34</b>	Ø 65 x 42 cm Ø 25,6 x 16,5 in.	15 kg 33 lb.
	<b>NYO/PT 40</b> <b>NYO/PT 42</b> <b>NYO/PT 44</b>	Ø 90 x 42 cm Ø 35,4 x 16,5 in.	23,3 kg 51,4 lb.

ENVIRONMENTAL IMPACT				FIRE RESISTANCE	RÉSISTANCE AU FEU
				RESISTENCIA AL FUEGO	RESISTENZA AL FUOCO
Materials may be easily disassembled to be recycled.	Materiales fácilmente segregables para su posterior reciclado.	<i>Matériaux facilement démontables pour leurs recyclages.</i>	<i>Materiali facilmente separabile per un successivo riciclaggio.</i>	UNE-EN 13501-1	A1-s1, d0

WARRANTY	GARANTIA	GARANTIE	GARANZIA	PACKAGING	EMBALAJE	EMBALLAGE	IMBALLAGGIO
Two (2) year limited warranty. Does not cover: incorrect use, bad handling or deliberate damage.	Garantía de dos (2) años limitada. No cubre: mal uso, manipulación o daños intencionados.	<i>Garantie deux (2) ans. À l'exception: mauvaise utilisation, manipulation, dommages intentionnés.</i>	<i>Due (2) anni di garanzie limitati. Non copre: uso improprio, manipolazione o danno intenzionale.</i>	Cardboard box with plastic bag for product protection. One package.	Caja de cartón con bolsa de plástico para protección. Un paquete.	<i>Boîte en carton avec sac plastique pour la protection. Un paquet.</i>	<i>Scatola di cartone con sacchetto di plastica per protezione. Un pacco.</i>



BRAND COLORS

	BL · Ral 9003		VD · Ral 6000
	CE · Ral 7033		PE · Ral 5020
	GR · Ral 7015		AZ · Ral 5009
	AN · Ral 7016		BD · Ral 3005
	MA · Ral 8014		RJ · Ral 3020
	OP · Ral 1036		RS · Ral 2012
	VF · Ral 6020		AM · Ral 1007
	VO · Ral 6011		NJ · Ral 2017

OTHER FINISHES



TEXTURES

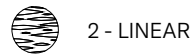
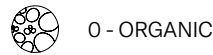

CUSTOMIZE OPTIONS  
OPCIONES PERSONALIZADAS

PERSONNALISER LES OPTIONS  
OPZIONI DI PERSONALIZZAZIONE



LABELS

Thickness  1,5 mm

Material  Iron

Finish  Painting

Conductivity  100%

Acoustic  Doesn't absorb sound

Fire resistance  UNE-EN 13501-1 A1-s1, d0

Optimal Space  Indoor / Outdoor

Cleaning  Water & Drying

Weight  See page 374



---

# Partitions

03

---

---

<b>190</b>	Go
<b>202</b>	Fuji
<b>210</b>	Oslo
<b>218</b>	Nikko

# Go

by Gemma Bernal

**GO is a mobile multifunctional metal furniture for offices and meeting spaces. Wardrobes, shelves, recycling bins, coat racks, acoustic panels and whiteboards can be combined with its extensive range of accessories. Also available in 16 colors from our RAL chart. Configurable system equipped with wheels with brakes.**

GO es un mueble metálico multifuncional móvil para oficinas y espacios de reuniones. Armarios, estanterías, papeleras de reciclaje, percheros, paneles acústicos y pizarras son combinables con su extensa gama de accesorios. Además disponible en 16 colores de nuestra carta RAL. Sistema configurable dotado de ruedas con freno.

*GO est un mobilier métallique multifonctionnel mobile pour bureaux et espaces de réunion. Armoires, étagères, poubelles de recyclage, porte-manteaux, panneaux acoustiques et tableaux blancs peuvent être combinés grâce à sa vaste gamme d'accessoires. Également disponible en 16 couleurs de notre nuancier RAL. Système configurable équipé de roues avec freins.*

GO è un mobile metallico multifunzionale per uffici e spazi meeting. Armadi, scaffali, contenitori per la raccolta differenziata, appendiabiti, pannelli acustici e lavagne possono essere combinati con la sua vasta gamma di accessori. Disponibile anche in 16 colori dalla nostra tabella RAL. Sistema configurabile dotato di ruote con freno.













Thanks to its versatility, the GO configurable modular system allows you to design meeting and training areas based on the number of participants on each occasion.

*Grâce à sa polyvalence, le système modulaire configurable GO vous permet de concevoir des espaces de réunion et de formation en fonction du nombre de participants à chaque occasion.*

Gracias a su versatilidad, el sistema modular configurable GO, permite diseñar áreas de reuniones y de formación en función al número de participantes en cada ocasión.

*Grazie alla sua versatilità, il sistema modulare configurabile GO consente di progettare aree di incontro e formazione in base al numero di partecipanti in ogni occasione.*



# More about GO

DESIGNER

Gemma Bernal





YEAR

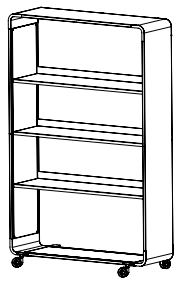



2024

LINE SKETCH



SCALE 1:20 (cm)

PRODUCT	REFERENCE	SIZE
	<b>GOO 10</b> Structure & wheels	180 x 115 x 35 cm 70,9 x 45,3 x 13,8 in.
	<b>GOO 101</b> Shelf	31 x 110 cm 12,2 x 43,3 in.
	<b>GOO 102</b> Shelf + hanging bar	31 x 110 cm - Ø 2 cm 12,2 x 43,3 in. - Ø 0,8 in.
	<b>GOO 103</b> Lacquered whiteboard	170 x 110 cm 66,9 x 43,3 in.
	<b>GOO 104</b> Enamel whiteboard	170 x 110 cm 66,9 x 43,3 in.

PRODUCT	REFERENCE	SIZE
	<b>GOO 113</b> Laquered whiteboard	85 x 110 cm 33,5 x 43,3 in.
	<b>GOO 114</b> Enamel whiteboard	85 x 110 cm 33,5 x 43,3 in.
	<b>GOO 105</b> Pet panel	170 x 110 cm 66,9 x 43,3 in.
	<b>GOO 115</b> Pet panel	85 x 110 cm 33,5 x 43,3 in.
	<b>GOO 107</b> TV support	39,4 x 16 cm 15,5 x 6,3 in.



MAGNETIC TRAY / ACCESSORIES





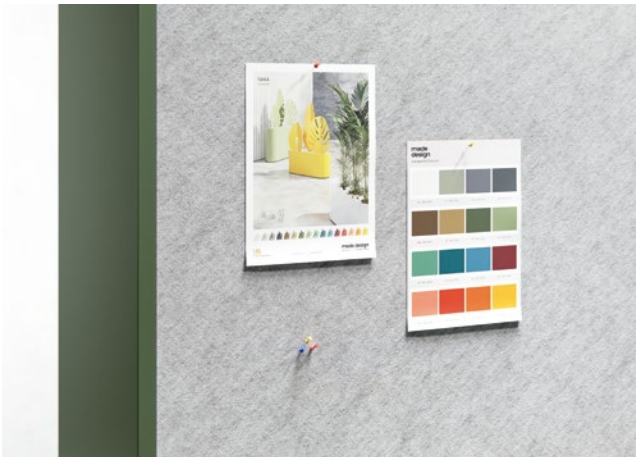
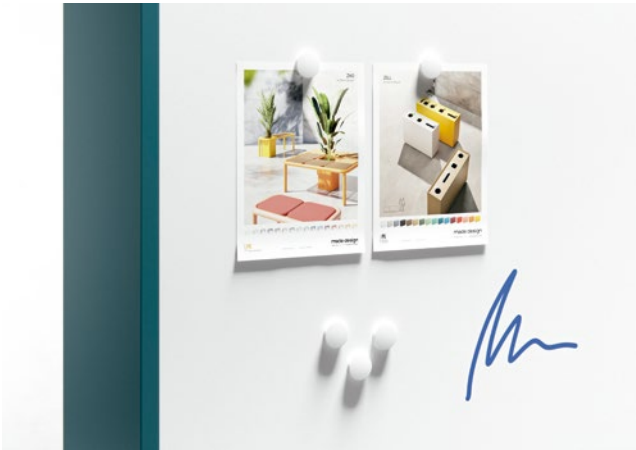
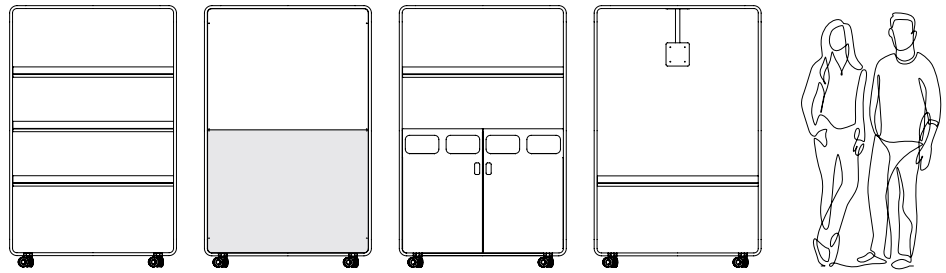





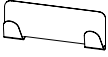
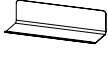

MAGNETIC WASTEPAPER / ACCESSORIES

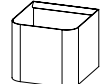

WHITEBOARD / PET ACOUSTIC PANEL

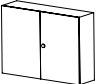
MAGNETIC HANGER

PRODUCT	REFERENCE	SIZE	PRODUCT	REFERENCE	SIZE
	<b>GOO 108</b> Magnetic hanger	10 x 30 cm - ∠ 25° 3,9 x 11,8 in.		<b>SAG 80</b> Marker pen tray	20 x 5,5 x 6,7 cm 68,9 x 35 x 19,7 in.
	<b>GOO 109</b> Magnetic wastepaper	25 x 17 x 17 cm 9,8 x 6,7 x 6,7 cm		<b>SAG 81</b> Magnetic eraser	15,5 x 7 x 4,7 cm 7,9 x 2,2 x 2,6 cm
	<b>GOO 110</b> Magnetic tray	10 x 30 x 10 cm 3,9 x 11,8 x 3,9 in.		<b>SAG 82</b> Vertical marker holder	14 x 5,5 x 3,5 cm 6,1 x 2,7 x 1,8 in.
	<b>GOO 120</b> Recycling kit	65 x 110 x 31 cm 25,6 x 43,3 x 12,2 in.		<b>SAG 83</b> Container Cup	11,5 x 9,3 x 11 cm 4,5 x 3,7 x 4,3 in.
	<b>GOO 130</b> Recycling cabinet	85 x 110 x 30 cm 33,5 x 43,3 x 11,8 in.		<b>9003</b> Pack of 6 white magnets	∅ 25 mm
	<b>GOO 140</b> Cabinet	80 x 110 x 30 cm 31,5 x 43,3 x 11,8 in.		<b>7005</b> Pack of 4 Markers	



ROUND CORNER & SHELF



LEVELERS & CASTORS





RECYCLING KIT



RECYCLING CABINET



HANGER / CABINET

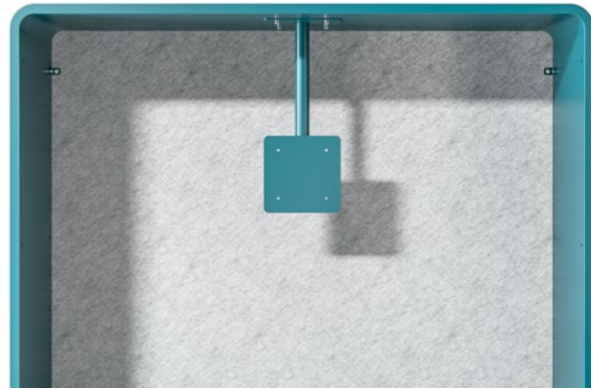

TV SUPPORT / SHELF























HANGER / CABINET



TV SUPPORT / SHELF

CHARACTERISTICS	CARACTERÍSTICAS	CARACTÉRISTIQUES	CARATTERISTICHE
Modular furniture made of 1.2 mm sheet metal. Its structure is welded and polished forming a perfect ring. The metal feet made of 4 mm handrails. Equipped with wheels with brakes (2 front) The accessories and components are fixed to the body using screws. External accessories by magnet.	Mueble modular fabricado en chapa metálica de 1,2 mm. Su estructura está soldada y pulida formando un aro perfecto. Los pies metálicos fabricados en pasamanos de 4 mm. Dotados de ruedas con freno (2 delanteras) Los accesorios y componentes se fijan al cuerpo mediante tornillería. Los complementos exteriores mediante imán.	Mobilier modulaire en tôle de 1,2 mm. Sa structure est soudée et polie formant un anneau parfait. Les pieds métalliques constitués de mains courantes de 4 mm. Equipé de roues avec freins (2 à l'avant) Les accessoires et composants sont fixés à la carrosserie à l'aide de vis. Accessoires externes par aimant.	Mobili componibili realizzati in lamiera da 1,2 mm. La sua struttura è saldata e lucidata formando un anello perfetto. I piedini in metallo sono costituiti da corrimano da 4 mm. Dotato di ruote con freno (2 anteriori). Gli accessori e componenti sono fissati alla scocca tramite viti. Accessori esterni tramite calamita.

















REF	↕↔		REF	↕↔			
	<b>GOO 100</b>	180 x 115 x 35 cm 70,9 x 45,3 x 13,8 in.	48,9 kg 107,8 lb.		<b>GOO 107</b>	39,4 x 16 cm 15,5 x 6,3 in.	0,8 kg 1,8 lb.
	<b>GOO 101</b>	31 x 110 cm 12,2 x 43,3 in.	3,7 kg 8,1 lb.		<b>GOO 108</b>	10 x 30 cm - ∠ 25° 3,9 x 11,8 in.	0,3 kg 0,7 lb.
	<b>GOO 102</b>	31 x 110 cm - Ø 2 cm 12,2 x 43,3 in. - Ø 0,8 in.	4,6 kg 10,1 lb.		<b>GOO 109</b>	25 x 17 x 17 cm 9,8 x 6,7 x 6,7 cm	1,7 kg 3,7 lb.
	<b>GOO 103</b>	110 x 170 cm 43,3 x 66,9 in.	12 kg 26,4 lb.		<b>GOO 110</b>	10 x 30 x 10 cm 3,9 x 11,8 x 3,9 in.	0,9 kg 1,9 lb.
	<b>GOO 104</b>	170 x 110 cm 66,9 x 43,3 in.	31 kg 68,3 lb.		<b>GOO 111</b>		
	<b>GOO 105</b>	85 x 110 cm 33,5 x 43,3 in.	7 kg 15,4 lb.		<b>GOO 112</b>		
	<b>GOO 106</b>	85 x 110 cm 33,5 x 43,3 in.	17 kg 37,5 lb.		<b>GOO 113</b>		
	<b>GOO 107</b>	170 x 110 cm 66,9 x 43,3 in.	3,6 kg 7,9 lb.		<b>GOO 114</b>		
	<b>GOO 108</b>	85 x 110 cm 33,5 x 43,3 in.	1,8 kg 3,9 lb.		<b>GOO 115</b>		

ENVIRONMENTAL IMPACT				FIRE RESISTANCE	RÉSISTANCE AU FEU
				RESISTENCIA AL FUEGO	RESISTENZA AL FUOCO
Materials may be easily disassembled to be recycled.	Materiales fácilmente segregables para su posterior reciclado.	Matériaux facilement démontables pour leurs recyclages.	Materiali facilmente separabile per un successivo riciclaggio.	UNE-EN 13501-1	A1-s1, d0

WARRANTY	GARANTIA	GARANTIE	GARANZIA	PACKAGING	EMBALAJE	EMBALLAGE	IMBALLAGGIO
Two (2) year limited warranty. Does not cover: incorrect use, bad handling or deliberate damage.	Garantía de dos (2) años limitada. No cubre: mal uso, manipulación o daños intencionados.	Garantie deux (2) ans. À l'exception: mauvaise utilisation, manipulation, dommages intentionnés.	Due (2) anni di garanzie limitati. Non copre: uso improprio, manipolazione o danno intenzionale.	Cardboard box with plastic bag for product protection. One package.	Caja de cartón con bolsa de plástico para protección. Un paquete.	Boîte en carton avec sac plastique pour la protection. Un paquet.	Scatola di cartone con sacchetto di plastica per protezione. Un pacco.



#### BRAND COLORS

 BL · Ral 9003	 VD · Ral 6000
 CE · Ral 7033	 PE · Ral 5020
 GR · Ral 7015	 AZ · Ral 5009
 AN · Ral 7016	 BD · Ral 3005
 MA · Ral 8014	 RJ · Ral 3020
 OP · Ral 1036	 RS · Ral 2012
 VF · Ral 6020	 AM · Ral 1007
 VO · Ral 6011	 NJ · Ral 2017

#### CUSTOMIZE OPTIONS









OPCIONES PERSONALIZADAS

#### PERSONNALISER LES OPTIONS

OPZIONI DI PERSONALIZZAZIONE

 RAL COLOR

#### LABELS

Thickness  1,2 mm	Acoustic  Doesn't absorb sound
Material  Iron	Fire resistance  UNE-EN 13501-1 A1-51,d0
Finish  Painting	Optimal Space  Indoor
Conductivity  100%	Cleaning  Water & Drying
	Weight  48,9 kg / 107,8 lb. unit

# Fuji

by Roger Vancells

**Fuji arrives to adapt to any of your spaces. This dynamic multifunctional folding screen system is ideal to cover a variety of needs. Thanks to its mobility, it allows you to quickly arrange the necessary elements according to their use. Whiteboard, acoustic fabric or simply an acrylic space divider.**

*Fuji arrive pour s'adapter à tous vos espaces. Ce système dynamique de cloison multifonctionnelle est idéal pour couvrir un bon nombre de vos besoins. Grâce à sa mobilité, il vous permet de disposer rapidement des éléments nécessaires en fonction de leur utilisation. Tableau émaillé, tissu acoustique ou simplement un séparateur d'espace avec acrylique.*

Llega Fuji para adaptarse a cualquiera de tus espacios. Este dinámico sistema de biombo multifuncional, es ideal para cubrir diversidad de necesidades. Gracias a su movilidad, permite de manera rápida disponer los elementos necesarios según su uso. Pizarra, tejido acústico o simplemente un divisor de espacios con acabado acrílico.

Fuji è arrivato per adattarsi a qualsiasi vostro spazio. Questo dinamico sistema di partizione multifunzionale è ideale per coprire molte delle vostre esigenze. Grazie alla sua mobilità, permette di disporre rapidamente gli elementi necessari secondo il loro uso. Lavagna, tessuto acustico o semplicemente un divisore di spazio con finitura acrilica.

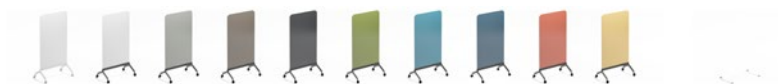







# More about Fuji

DESIGNER

Roger Vancells

YEAR

2022

LINE SKETCH

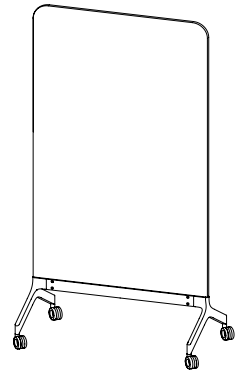

SCALE 1:20 (cm)

PRODUCT

REFERENCE

SIZE



**FUJ P**

175 x 90 x 50 cm  
68,9 x 35 x 19,7 in.  
P · Whiteboard

**FUJ T**

175 x 90 x 50 cm  
68,9 x 35 x 19,7 in.  
T · Textile

PRODUCT

REFERENCE

SIZE



**FUJ NIV**

4,9 x 4,03 x 1,2 cm  
1,92 x 1,59 x 0,47 in.  
Optional levellers



**SAG 80**

Marker pen tray

20 x 5,5 x 6,7 cm  
68,9 x 35 x 19,7 in.



**SAG 81**

Magnetic eraser

15,5 x 7 x 4,7 cm  
7,9 x 2,2 x 2,6 cm

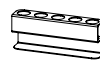

**SAG 82**

Vertical marker holder

14 x 5,5 x 3,5 cm  
6,1 x 2,7 x 1,8 in.







LEVELLERS & CASTORS



EIGHT DIFFERENT COLOURS OF TEXTILE



PRODUCT	REFERENCE	SIZE
	<b>SAG 83</b> Container Cup	11,5 x 9,3 x 11 cm 4,5 x 3,7 x 4,3 in.
	<b>9003</b> Pack of 6 white magnets	Ø 25 mm
	<b>7005</b> Pack of 4 Markers	

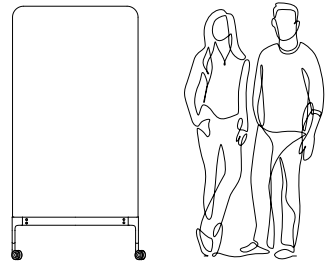

BLACK & WHITE MICROTTEXTURED SRUCTURE & CASTORS



# Fuji

by Roger Vancells

← VIEW PRODUCT PAGES

202

CHARACTERISTICS	CARACTERÍSTICAS	CARACTÉRISTIQUES	CARATTERISTICHE
Partition screen available in methacrylate panel, upholstered in 8 different colours and with whiteboard, structure with wheels in black or white. It allows to separate spaces and to move easily.	Biombo separador disponible en panel de metacrilato, tapizado en 8 colores diferentes y con pizarra, estructura en color blanco o negro con ruedas. Permite separar espacios y desplazarse con facilidad.	Paroi de séparation disponible en panneau de méthacrylate, tapissée en 8 couleurs différentes et avec tableau, en structure blanche ou noire avec roues. Il permet de séparer les espaces et peut se déplacer facilement.	Paravento disponibile in pannello di metacrilato, rivestito in 8 colori diversi e con lavagna, in struttura bianca o nera con ruote. Permette di separare gli spazi e si muove facilmente.

	REF	↕↔	📏
	<b>FUJ P</b>	175 x 90 x 50 cm 68,9 x 35 x 19,7 in.	18 kg 39,7 lb.
	<b>FUJ TR</b> <b>FUJ FM</b> <b>FUJ HM</b>	175 x 90 x 50 cm 68,9 x 35 x 19,7 in.	18 kg 39,7 lb.
	<b>FUJ T</b>	175 x 90 x 50 cm 68,9 x 35 x 19,7 in.	14 kg 30,89 lb.
	<b>FUJ NIV</b>	4,9 x 4,03 x 1,2 cm 1,92 x 1,59 x 0,47 in.	0,11 kg 0,24 lbs

ENVIRONMENTAL IMPACT				FIRE RESISTANCE	RÉSISTANCE AU FEU
				RESISTENCIA AL FUEGO	RESISTENZA AL FUOCO
Materials may be easily disassembled to be recycled.	Materiales fácilmente segregables para su posterior reciclado.	<i>Matériaux facilement démontables pour leurs recyclages.</i>	<i>Materiali facilmente separabile per un successivo riciclaggio.</i>	UNE-EN 13501-1	A1-s1, d0 D-s2, d0 A1-s1, d0

WARRANTY	GARANTIA	GARANTIE	GARANZIA	PACKAGING	EMBALAJE	EMBALLAGE	IMBALLAGGIO
Two (2) year limited warranty. Does not cover: incorrect use, bad handling or deliberate damage.	Garantía de dos (2) años limitada. No cubre: mal uso, manipulación o daños intencionados.	<i>Garantie deux (2) ans. À l'exception: mauvaise utilisation, manipulation, dommages intentionnés.</i>	<i>Due (2) anni di garanzie limitati. Non copre: uso improprio, manipolazione o danno intenzionale.</i>	Cardboard box with plastic bag for product protection. Two packages.	Caja de cartón con bolsa de plástico para protección. Dos paquetes.	<i>Boîte en carton avec sac plastique pour la protection. Deux paquets.</i>	<i>Scatola di cartone con sacchetto di plastica per protezione. Dues pacchi.</i>

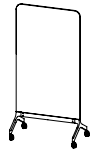









TEXTILE COLORS HUSH STRIPE 40 by Gabriel

- GR · 61226
- BD · 63058
- GT · 61225
- AC · 67046
- AN · 60900
- AZ · 66133
- AM · 62068
- VD · 68103

CUSTOMIZE OPTIONS      PERSONNALISER LES OPTIONS  
 OPCIONES PERSONALIZADAS      OPZIONI DI PERSONALIZZAZIONE

- P · WHITEBOARD
- ENAMELLED STEEL

LABELS

Thickness		10 mm	Acoustic		35% (Textile Version)
Material		Aluminium + Textile or Steel	Fire resistance		UNE-EN 13501-1 A1-s1, d0 / D-s2, d0
Finish		Textile or Enamel Steel	Optimal Space		Indoor
Conductivity		100%	Cleaning		Water & Drying
			Weight		See page 240

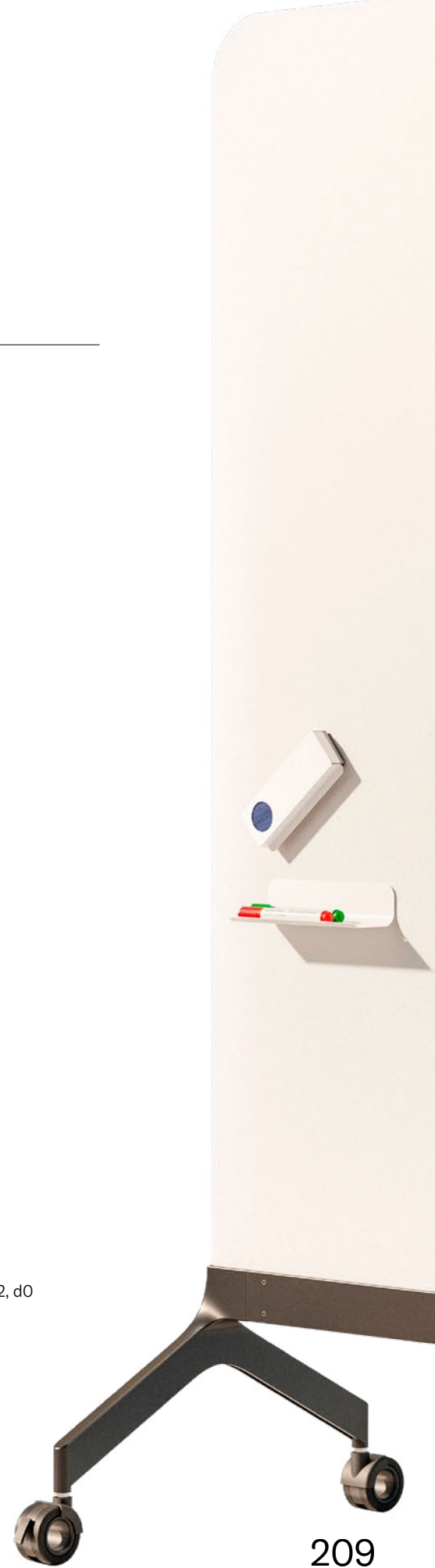

# Oslo

by Muka Design Lab

**Its purpose is to subtly separate ambiances. Oslo combines the transparency of translucent methacrylate or its acoustic finishes with the sinuousness of its shapes. Structure with metal base and white lacquered aluminium profile.**

Separar ambientes de manera sutil es su cometido. Oslo combina las transparencias de los metacrilatos translúcidos o de sus acabados acústicos, con la sinuosidad de sus formas. Estructura con base metálica y perfil de aluminio lacado blanco.

*Séparer les environnements de manière subtile, telle est sa mission. Oslo combine les transparences des méthacrylate translucides ou ses finitions acoustiques avec la sinuosité de ses formes. Structure avec base métallique et profil en aluminium laqué blanc.*

**Separare gli ambienti in modo sottile è la sua missione. Oslo combina le trasparenze dei metacrilato traslucidi o le sue finiture acustiche con la sinuosità delle sue forme. Struttura con base in metallo e profilo in alluminio laccato bianco.**



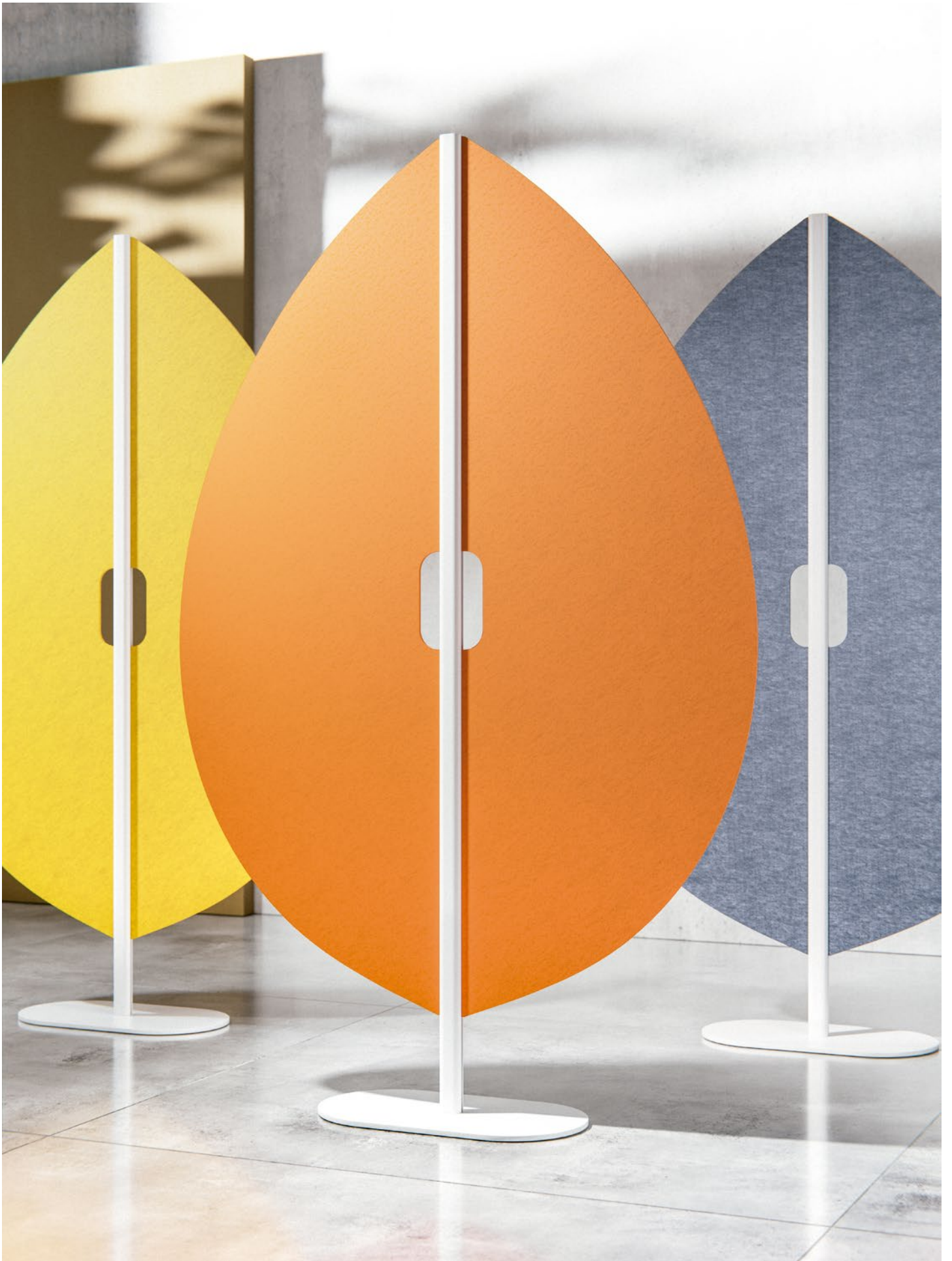





# More about Oslo

DESIGNER

Muka Design Lab

YEAR

2022

LINE SKETCH

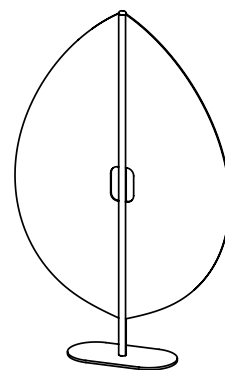

SCALE 1:20 (cm)

PRODUCT

REFERENCE

SIZE

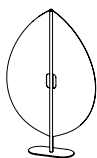

**OSL 19 PFA**

190 x 121 x 30 cm  
74,80 x 47,64 x 11,81 in.

PFA · Acoustic



METALLIC BASE



CARRYING HANDLE



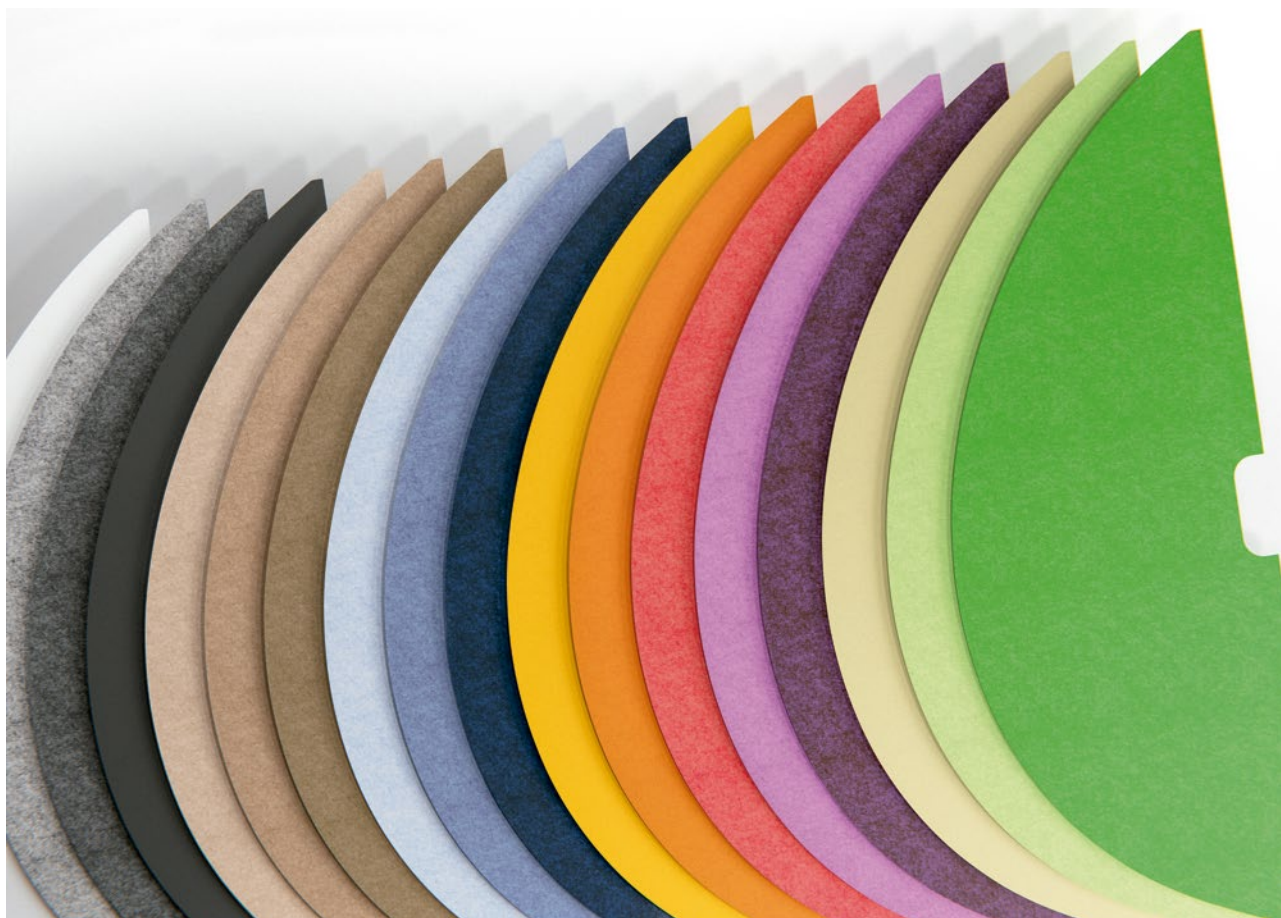
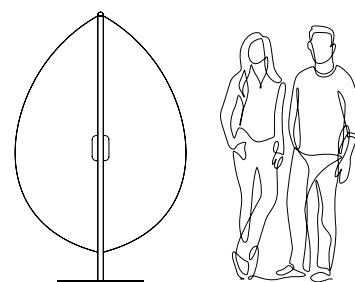

# Oslo

by Muka Design Lab

← VIEW PRODUCT PAGES

210

CHARACTERISTICS	CARACTERÍSTICAS	CARACTÉRISTIQUES	CARATTERISTICHE
Leaf-shaped partition screen made of transparent PMA, brown fume, matte ice and PFA in 18 different colours. With central structure in matt white iron.	Biombo separador en forma de hoja fabricado en PMA transparente, fume marrón, hielo mate y PFA en 18 colores diferentes. Con estructura central de hierro blanco mate.	Cloison de séparation en forme de feuille en PMA transparent, en brun fumé, matte et en PFA en 18 couleurs différentes. Avec structure centrale en fer blanc mat.	Schermo divisorio a forma di foglia in PMA trasparente, fumé marrone, opaco e PFA in 18 colori diversi. Con struttura centrale in ferro bianco opaco.

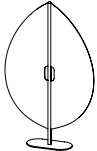
REF	↕↔	📏
 <b>OSL 19 PFA</b>	190 x 121 x 30 cm 74,80 x 47,64 x 11,81 in.	14 kg 30,9 lb.

ENVIRONMENTAL IMPACT				FIRE RESISTANCE	RÉSISTANCE AU FEU
				RESISTENCIA AL FUEGO	RESISTENZA AL FUOCO
Materials may be easily disassembled to be recycled.	Materiales fácilmente segregables para su posterior reciclado.	<i>Matériaux facilement démontables pour leurs recyclages.</i>	<i>Materiali facilmente separabile per un successivo riciclaggio.</i>	EN 14509 - 2006	

WARRANTY	GARANTIA	GARANTIE	GARANZIA	PACKAGING	EMBALAJE	EMBALLAGE	IMBALLAGGIO
Two (2) year limited warranty. Does not cover: incorrect use, bad handling or deliberate damage.	Garantía de dos (2) años limitada. No cubre: mal uso, manipulación o daños intencionados.	<i>Garantie deux (2) ans. À l'exception: mauvaise utilisation, manipulation, dommages intentionnés.</i>	<i>Due (2) anni di garanzie limitati. Non copre: uso improprio, manipolazione o danno intenzionale.</i>	Cardboard box with plastic bag for product protection. One package.	Caja de cartón con bolsa de plástico para protección. Un paquete.	<i>Boîte en carton avec sac plastique pour la protection. Un paquet.</i>	<i>Scatola di cartone con sacchetto di plastica per protezione. Un pacco.</i>

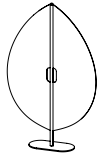

PET COLORS

 BO-00	 AM - 90
 GM- 08	 IL - 18
 GM - 92	 NR - 09
 GS - 96	 RO - 60
 NO - 00	 RS - 31
 BE - 07	 RS - 67
 BE - 32	 VR - 07
 AZ - 05	 VR - 11
 AZ - 25	 VR - 25

CUSTOMIZE OPTIONS









PERSONNALISER LES OPTIONS

OPCIONES PERSONALIZADAS

OPZIONI DI PERSONALIZZAZIONE



LABELS

Thickness  9 mm	Acoustic  PET 50%
Material  PET + Aluminium	Fire resistance  EN 14509 - 2006
Finish  PET	Optimal Space  Indoor
Conductivity  -	Cleaning  Water & Drying
	Weight  See page 248



# Nikko



by MD Design Lab

**Nikko is a collection of 'fresh-office' furniture with qualities that are highly sensitive features to sustainability values and high sound-absorbing capacity. It allows in an easy, light and functional way to create workspaces for many people, generating dynamic and flexible environments while preserving privacy.**

*Nikko est une collection de mobilier de bureau "frais" aux qualités très sensibles aux valeurs de durabilité et à la capacité d'absorption acoustique élevée. Il permet de manière simple, légère et fonctionnelle de créer des espaces de travail pour plusieurs personnes, générant des environnements dynamiques et flexibles tout en préservant l'intimité.*

Nikko es una colección de mobiliario 'fresh-office' con cualidades muy sensibles a valores de sostenibilidad y alta capacidad fonoabsorbente. Permite de una manera fácil, ligera y funcional formar espacios de trabajo de varias personas generando entornos dinámicos y flexibles conservando la privacidad.

Nikko è una collezione di mobili 'fresh-office' con qualità altamente sensibili ai valori di sostenibilità e un'alta capacità di assorbimento del suono. Permette in modo facile, leggero e funzionale di creare spazi di lavoro per più persone, generando ambienti dinamici e flessibili pur conservando la privacy.









# More about Nikko

DESIGNER

MD design Lab

YEAR

2022

PRODUCT

REFERENCE

SIZE

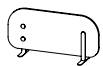

**NIK 20**

45 x 90 x 1,8 cm  
17,7 x 35,4 x 0,7 in.

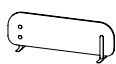

**NIK 21**

45 x 130 x 1,8 cm  
17,7 x 51,2 x 0,7 in.

LINE SKETCH

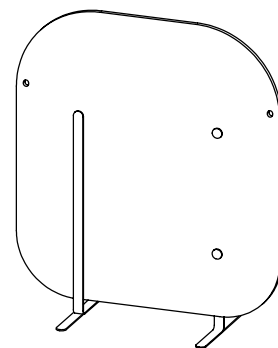

SCALE 1:20 (cm)

PRODUCT

REFERENCE

SIZE



**NIK 30**

110 x 125 x 1,8 cm  
43,3 x 49,2 x 0,7 in.

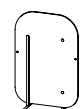

**NIK 31**

110 x 165 x 1,8 cm  
43,3 x 65 x 0,7 in.



**NIK 32**

125 x 140 x 1,8 cm  
49,2 x 55,1 x 0,7 in.



THREE CONNECTORS OPTIONS



THREE PARTITION SIZES



PRODUCT	REFERENCE	SIZE
	<b>NIK 110</b>	12 x 4 x 2,3 cm 4,7 x 1,6 x 0,9 in. 90° Partitions connector
	<b>NIK 111</b>	12 x 4 x 2,3 cm 4,7 x 1,6 x 0,9 in. 135° Partitions connector
	<b>NIK 112</b>	12 x 4 x 2,3 cm 4,7 x 1,6 x 0,9 in. 180° Partitions connector

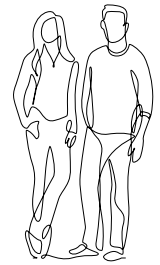
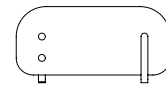
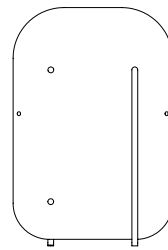

RANGE COLORS



135° PARTITION CONNECTOR







# Nikko

by MD Design Lab

← VIEW PRODUCT PAGES

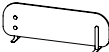
218

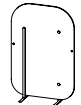
CHARACTERISTICS	CARACTERÍSTICAS	CARACTÉRISTIQUES	CARATTERISTICHE
Collection of freestanding and tabletop sound-absorbing panels, made of 9 mm PFA and available in 18 colors. Anthracite grey metal structure.	Colección de biombos separadores fonoabsorbentes, de pie y sobremesa, en PFA de 9 mm. y disponible en 18 colores. Estructura metálica, gris antracita.	Collection de paravents séparateurs phono-absorbants, sur pied et de table, en PFA de 9 mm, disponible en 18 couleurs. Structure métallique gris anthracite.	Collezione di separatori fonoassorbenti, da pavimento e da tavolo, in PFA da 9 mm, disponibile in 18 colori. Struttura in metallo grigio antracite.

	REF	↕↔		REF	↕↔	
	<b>NIK 20</b>	45 x 90 x 1,8 cm 17,7 x 35,4 x 0,7 in.	3 kg 6,6 lb.	<b>NIK 110</b>	12 x 4 x 2,3 cm 4,7 x 1,6 x 0,9 in.	0,238 kg 0,5 lb.
	<b>NIK 21</b>	45 x 130 x 1,8 cm 17,7 x 51,2 x 0,7 in.	5 kg 11,1 lb.	<b>NIK 111</b>	12 x 4 x 2,3 cm 4,7 x 1,6 x 0,9 in.	0,252 kg 0,6 lb.
	<b>NIK 30</b>	110 x 125 x 1,8 cm 43,3 x 49,2 x 0,7 in.	6 kg 13,2 lb.	<b>NIK 112</b>	12 x 4 x 2,3 cm 4,7 x 1,6 x 0,9 in.	0,266 kg 0,6 lb.
	<b>NIK 31</b>	110 x 165 x 1,8 cm 43,3 x 65 x 0,7 in.	9 kg 19,8 lb.			
	<b>NIK 32</b>	125 x 140 x 1,8 cm 49,2 x 55,1 x 0,7 in.	7 kg 15,4 lb.			

ENVIRONMENTAL IMPACT				FIRE RESISTANCE	RÉSISTANCE AU FEU
				RESISTENCIA AL FUEGO	RESISTENZA AL FUOCO
Materials may be easily disassembled to be recycled.	Materiales fácilmente segregables para su posterior reciclado.	<i>Matériaux facilement démontables pour leurs recyclages.</i>	<i>Materiali facilmente separabile per un successivo riciclaggio.</i>	UNE-EN 13501-1	A1-s1, d0

WARRANTY	GARANTIA	GARANTIE	GARANZIA	PACKAGING	EMBALAJE	EMBALLAGE	IMBALLAGGIO
Two (2) year limited warranty. Does not cover: incorrect use, bad handling or deliberate damage.	Garantía de dos (2) años limitada. No cubre: mal uso, manipulación o daños intencionados.	<i>Garantie deux (2) ans. À l'exception: mauvaise utilisation, manipulation, dommages intentionnés.</i>	<i>Due (2) anni di garanzie limitati. Non copre: uso improprio, manipolazione o danno intenzionale.</i>	Cardboard box with plastic bag for product protection. One package.	Caja de cartón con bolsa de plástico para protección. Un paquete.	<i>Boîte en carton avec sac plastique pour la protection. Un paquet.</i>	<i>Scatola di cartone con sacchetto di plastica per protezione. Un pacco.</i>

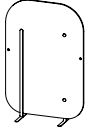

COLORS

- GR · Ral 7015 ACOUSTIC
- AN · Ral 7016 STRUCTURE

PET COLORS

- BO-00
- AM - 90
- GM- 08
- IL - 18
- GM - 92
- NR - 09
- GS - 96
- RO - 60
- NO - 00
- RS - 31
- BE - 07
- RS - 67
- BE - 32
- VR - 07
- AZ - 05
- VR - 11
- AZ - 25
- VR - 25

CUSTOMIZE OPTIONS      PERSONNALISER LES OPTIONS  
 OPCIONES PERSONALIZADAS      OPZIONI DI PERSONALIZZAZIONE

- RAL COLOR

LABELS

Thickness		18 mm	Acoustic		50%
Material		PET + Iron	Fire resistance		UNE-EN 13501-1 A1-s1, d0
Finish		PET	Optimal Space		Indoor
Conductivity		-	Cleaning		Water & Drying
			Weight		See page 256

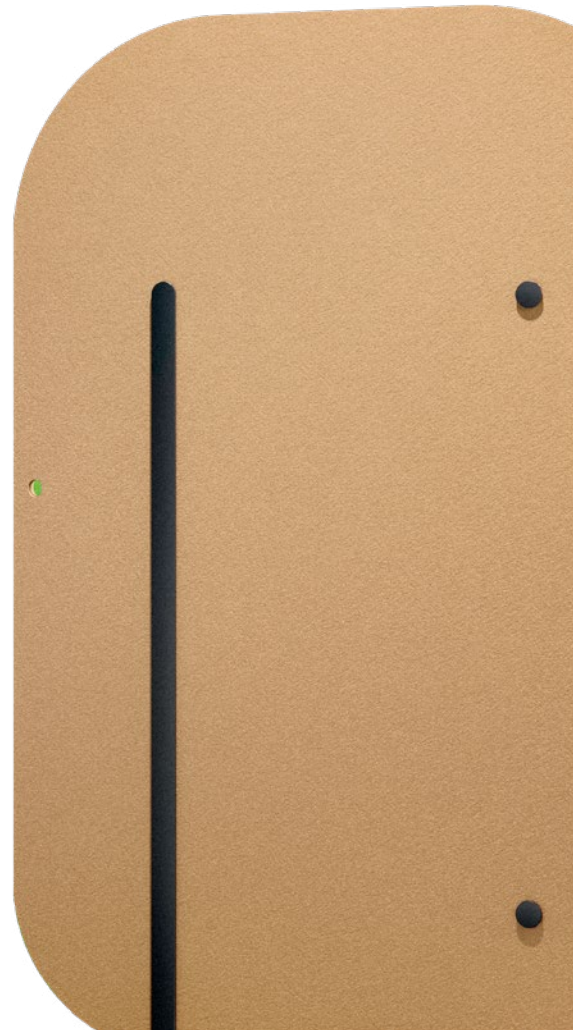

---

# Contract

04

---

---

<b>228</b>	Saga
<b>236</b>	Nagoya
<b>244</b>	Osaka
<b>252</b>	Zao
<b>260</b>	Niseko
<b>268</b>	Menfis
<b>278</b>	Linear
<b>286</b>	Sapporo
<b>294</b>	Albury
<b>302</b>	Obliqua

# Saga

by MD Design Lab

**Setting limits to a wall does not have to be an obligation. Saga allows, in a modular way, to achieve any objective you set yourself when it comes to configuring a training room or a creative environment. Space to write, to project, to exhibit, whatever you want, let your imagination run wild.**

*Fixer des limites à un mur ne devrait pas être une obligation. Saga permet, de manière modulaire, de matérialiser tous les objectifs que vous proposez lors de la configuration d'une salle de formation ou d'un environnement créatif. Un espace pour écrire, pour projeter, pour exposer, tout ce que vous voulez, laissez votre imagination s'exprimer.*

Ponerle límites a una pared no tiene que ser una obligación. Saga permite materializar, de manera modular, cualquier objetivo que te propongas a la hora de configurar una sala de formación o un entorno creativo. Espacio para escribir, para proyectar, para exponer, lo que tú quieras, deja volar tu imaginación.

**Mettere dei limiti a un muro non deve essere un obbligo. Saga permette, in modo modulare di materializzare qualsiasi obiettivo che vi proponete quando configurate una sala di formazione o un ambiente creativo. Uno spazio per scrivere, per proiettare, per esporre, qualsiasi cosa tu voglia, lascia correre la tua immaginazione.**









The whiteboard is divided into three vertical sections. The left section contains a line graph with a y-axis labeled 'M' and values 100, 200, 300, 400. The x-axis has labels J, F, M, A, M, J. A line connects points at approximately (J, 200), (F, 400), (M, 300), (A, 250), (M, 350), and (J, 500). Vertical dashed lines connect these points to the x-axis. To the left of the graph are two small photos and a set of colored markers. The middle section is a grey textured area with two small photos. The right section is white and contains a small whiteboard on a stand and a cluster of small white squares.



# More about Saga

DESIGNER

MD Design Lab

YEAR

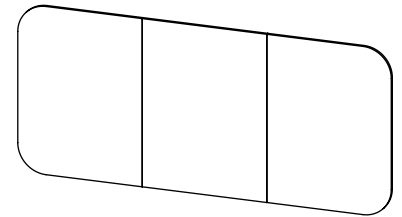

2022

LINE SKETCH

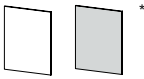
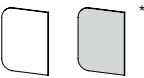
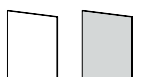

SCALE 1:20 (cm)

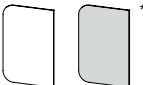
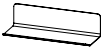
PRODUCT	REFERENCE	SIZE
	<b>SAG 10 P</b> <b>SAG 10 PFA*</b>	88 x 118 x 1 cm 34,6 x 46,4 x 0,39 in.
	<b>SAG 11 P</b> <b>SAG 11 PFA*</b>	88 x 118 x 1 cm 34,6 x 46,4 x 0,39 in.
	<b>SAG 20 P</b> <b>SAG 20 PFA*</b>	98 x 148 x 1 cm 38,5 x 58,2 x 0,39 in.





PRODUCT	REFERENCE	SIZE
	<b>SAG 21 P</b> <b>SAG 21 PFA*</b>	98 x 148 x 1 cm 38,5 x 58,2 x 0,39 in.
	<b>SAG 80</b> Marker pen tray	20 x 6,7 x 5,5 cm 7,8 x 2,6 x 2,1 in.
	<b>SAG 81</b> Magnetic eraser	15,5 x 7 x 4,7 cm 6,1 x 2,7 x 1,8 in.
	<b>SAG 82</b> Vertical marker holder	14 x 3,5 x 5,5 cm 5,5 x 1,3 x 2,1 in.



ACOUSTIC PANEL IN 7 DIFFERENT COLOURS



WHITEBOARD

PRODUCT	REFERENCE	SIZE
	<b>SAG 83</b> Container Cup	11,5 x 11 x 9,3 cm 4,5 x 4,3 x 3,6 in.
	<b>9003</b> Pack of 6 white magnets	Ø 25 mm
	<b>7005</b> Pack of 4 Markers	

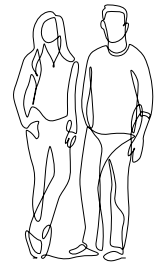
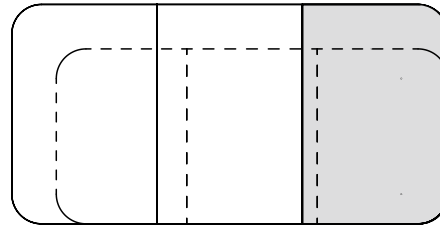

ACCESSORIES: MAGNETS / ERASER / TRAY

ACCESSORIES / MARKER HOLDERS

# Saga

by MD Design Lab

← VIEW PRODUCT PAGES

228

## CHARACTERISTICS

Set of whiteboards and sound-absorbing panels. Composed by a central rectangular part and rounded corner sides, available in PFA and magnetic enamelled steel board. Each piece fits separately to the wall by means of a magnetic panel making it modular.

## CARACTERÍSTICAS









Conjunto de pizarras y paneles fonoabsorbentes. Compuesto por una pieza central rectangular y unos laterales redondeados disponibles en PFA y en pizarra de acero vitrificado magnético. Cada pieza se ajusta por separado a la pared por medio de paneles magnéticos, haciéndolo modular.

## CARACTÉRISTIQUES

Ensemble de tableaux et de panneaux phono absorbants. Composé d'une pièce centrale rectangulaire et de pièces latérales avec côtés arrondis, disponibles en PFA et en acier émaillé magnétique. Chaque pièce s'adapte séparément au mur par moyen d'un panneau magnétique, ce qui le rend modulaire.

## CARATTERISTICHE

Set di lavagne e pannelli fonoassorbenti. Composto da un pannello centrale rettangolare e pezzi laterali con lati arrotondati, disponibili in PFA e in acciaio magneticosmaltato. Ogni pezzo si adatta separatamente al muro per mezzo di un pannello magnetico che lo rende modulare.

REF	↕↔	📏	REF	↕↔	📏
 <b>SAG 10 P</b>	88cm x 118cm x 1 cm 34,64 x 46,46 x 0,39 in.	16 kg 35,2 lb.	 <b>SAG 20 P</b>	98cm x 148cm x 1 cm 38,58 x 58,27 x 0,39 in.	23 kg 50,7 lb.
 <b>SAG 10 PFA</b>	88cm x 118cm x 1 cm 34,64 x 46,46 x 0,39 in.	4 kg 8,8 lb.	 <b>SAG 20 PFA</b>	98cm x 148cm x 1 cm 38,58 x 58,27 x 0,39 in.	7 kg 15,4 lb.
 <b>SAG 11 P</b>	88cm x 118cm x 1 cm 34,64 x 46,46 x 0,39 in.	15,8 kg 34,8 lb.	 <b>SAG 21 P</b>	98cm x 148cm x 1 cm 38,58 x 58,27 x 0,39 in.	22,7 kg 50 lb.
 <b>SAG 11 PFA</b>	88cm x 118cm x 1 cm 34,64 x 46,46 x 0,39 in.	4 kg 8,8 lb.	 <b>SAG 21 PFA</b>	98cm x 148cm x 1 cm 38,58 x 58,27 x 0,39 in.	7 kg 15,4 lb.

## ENVIRONMENTAL IMPACT

Materials may be easily disassembled to be recycled.

Materiales fácilmente segregables para su posterior reciclado.

*Matériaux facilement démontables pour leurs recyclages.*

*Materiali facilmente separabile per un successivo riciclaggio.*

## FIRE RESISTANCE

RESISTENCIA AL FUEGO

## RÉSISTANCE AU FEU

RESISTENZA AL FUOCO

DIN - 4112

## WARRANTY

Two (2) year limited warranty. Does not cover: incorrect use, bad handling or deliberate damage.

## GARANTIA

Garantía de dos (2) años limitada. No cubre: mal uso, manipulación o daños intencionados.

## GARANTIE

*Garantie deux (2) ans. À l'exception: mauvaise utilisation, manipulation, dommages intentionnés.*

## GARANZIA

*Due (2) anni di garanzia limitati. Non copre: uso improprio, manipolazione o danno intenzionale.*

## PACKAGING

Cardboard box with plastic bag for product protection. One package.

## EMBALAJE

Caja de cartón con bolsa de plástico para protección. Un paquete.

## EMBALLAGE

*Boîte en carton avec sac plastique pour la protection. Un paquet.*

## IMBALLAGGIO

*Scatola di cartone con sacchetto di plastica per protezione. Un pacco.*

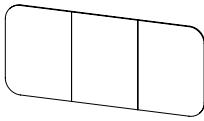









PET COLORS

WHITEBOARD

- |  |   |
|--|---|
|  BO-00   |  AM - 90 |
|  GM- 08  |  IL - 18 |
|  GM - 92 |  NR - 09 |
|  GS - 96 |  RO - 60 |
|  NO - 00 |  RS - 31 |
|  BE - 07 |  RS - 67 |
|  BE - 32 |  VR - 07 |
|  AZ - 05 |  VR - 11 |
|  AZ - 25 |  VR - 25 |

- |   |
|---|
|  P · ENAMELLED STEEL |
|---|

LABELS

Thickness	 10 mm	Acoustic	 Yes
Material	 Enamel Steel or PET	Fire resistance	 DIN - 4112
Finish	 Whiteboard or Acoustic	Optimal Space	 Indoor
Conductivity	 100% *steel version	Cleaning	 Water & Drying
		Weight	 See page 266



# Nagoya

---

by Joan Gaspar

**Arriving at the lectern to give a speech, you position yourself and realise this is not just any lectern, it's a unique design, solid and comfortable. Not only enhancing the stage with its upholstered structure and its sinuous shape this beautiful lectern stands out from the crowd and gives confidence to the orator.**

*Vous arrivez devant le pupitre pour donner un discours, vous vous y positionnez et vous vous rendez compte que ce n'est pas un pupitre, mais une pièce unique, solide et confortable. Non seulement il améliore votre espace avec sa structure rembourrée et sa forme sinueuse, mais il proportionne également de la sécurité à l'orateur.*

Llegas al atril para dar un discurso, te posicionas en él y ahí te das cuenta que no es un atril cualquiera, es una pieza única, sólida y confortable. No solo realza tu espacio con su estructura tapizada y su sinuosa forma, sino que además ofrece seguridad al orador.

Vai al leggio per dare un discorso, ti posizioni in esso e lì ti senti conto che non è un qualsiasi leggio, è un pezzo unico, solido e confortevole. Non solo valorizza il tuo spazio con la sua struttura imbottita e la sua forma sinuosa, ma offre anche sicurezza al oratore.









CONFERENCE ROOM



# More about Nagoya

---

DESIGNER

Joan Gaspar

---

YEAR

2010

---

LINE SKETCH

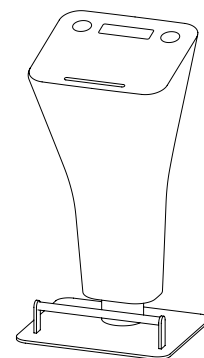

SCALE 1:20 (cm)

---

PRODUCT

REFERENCE

SIZE



**NAG 01**

60 x 50 x 114 cm  
23,6 x 19,7 x 44,9 in.



**NAG 02**

60 x 50 x 114 cm  
23,6 x 19,7 x 44,9 in.

**NAG 15**

Lamp

**NAG 20**

Microphone

**NAG 30**

A4 Sign



LED LIGHT AND MICROPHONE DETAIL

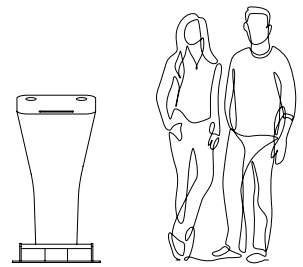

SPACE FOR PLUGS & CONNECTIONS - FOOTREST DETAIL

NAGOYA SET



# Nagoya

by Joan Gaspar

← VIEW PRODUCT PAGES

236

CHARACTERISTICS	CARACTERÍSTICAS	CARACTÉRISTIQUES	CARATTERISTICHE
Lectern made from an upholstered rotational polyethylene core. Metal base with 10mm sheet metal. Available fully wired up and including two power sockets, a microphone base and/or light. Incorporating cup holder and a bar to hold documents. Foot-rest bar in stainless steel. 2m electric cable.	Atril para conferencias fabricado mediante un núcleo de polietileno rotacional tapizado. Base metálica en chapa de hierro de 10 mm. Disponible versión electrificada que incluye un cajetín que contiene una regleta con dos tomas de corriente, una base para micrófono y/o luz. Incorpora reposa-vasos y barra sujeta documentos. Barra reposa-pies en acero inoxidable. Cable eléctrico de 2 m.	<i>Pupitre de conférence fabriqué avec un noyau en polyéthylène tapissé. Base métallique en tôle de 10 mm d'épaisseur. Version électrifiée disponible comprenant un accès contenant deux prises, une base pour microphone et/ou lumière. Incorpore des reposes verres et une reglette pour maintenir les documents. Barre repose-pieds en acier inoxydable. 2m de câble électrique.</i>	<i>Leggio per conferenze fabbricato mediante un nucleo in polietilene rotazionale imbottito. Base metallica in lamiera di ferro da 10 mm. Disponibile versione elettrificata che include una scatola contenente una ciabatta con due prese corrente, una base per microfono e/o luce. Incorpora poggiatesta e barra per contenere documenti. Barra poggiapiedi in acciaio inox. Cavo elettrico 2 mt.</i>

	REF	↕↔	📏
	<b>NAG 01</b>	60 x 50 x 114 cm 23,6 x 19,7 x 44,9 in.	35 kg 77,2 lb.
	<b>NAG 02</b>	60 x 50 x 114 cm 23,6 x 19,7 x 44,9 in.	35 kg 77,2 lb.
	<b>NAG 15</b> <b>NAG 20</b> <b>NAG 30</b>	Lamp Microphone A4 Sign	

ENVIRONMENTAL IMPACT				FIRE RESISTANCE	RÉSISTANCE AU FEU
				RESISTENCIA AL FUEGO	RESISTENZA AL FUOCO
Materials may be easily disassembled to be recycled.	Materiales fácilmente segregables para su posterior reciclado.	<i>Matériaux facilement démontables pour leurs recyclages.</i>	<i>Materiali facilmente separabile per un successivo riciclaggio.</i>	UNE-EN 13501-1	B-s1, d1

WARRANTY	GARANTIA	GARANTIE	GARANZIA	PACKAGING	EMBALAJE	EMBALLAGE	IMBALLAGGIO
Two (2) year limited warranty. Does not cover: incorrect use, bad handling or deliberate damage.	Garantía de dos (2) años limitada. No cubre: mal uso, manipulación o daños intencionados.	<i>Garantie deux (2) ans. À l'exception: mauvaise utilisation, manipulation, dommages intentionnés.</i>	<i>Due (2) anni di garanzie limitati. Non copre: uso improprio, manipolazione o danno intenzionale.</i>	Cardboard box with plastic bag for product protection. One package.	Caja de cartón con bolsa de plástico para protección. Un paquete.	<i>Boîte en carton avec sac plastique pour la protection. Un paquet.</i>	<i>Scatola di cartone con sacchetto di plastica per protezione. Un pacco.</i>











COLORS

-  BL · Ral 9003
-  AN · Ral 7016
-  VI · Ral 4007

CUSTOMIZE OPTIONS      PERSONNALISER LES OPTIONS  
 OPCIONES PERSONALIZADAS    OPZIONI DI PERSONALIZZAZIONE

 RAL COLOR

LABELS

Thickness	 -	Acoustic	 Doesn't absorb sound
Material	 Iron + Fabric	Fire resistance	 UNE-EN 13501-1 B-s1, d1
Finish	 Synthetic Leather	Optimal Space	 Indoor
Conductivity	 -	Cleaning	 Water & Drying
		Weight	 35 kg - 77,2 lb.

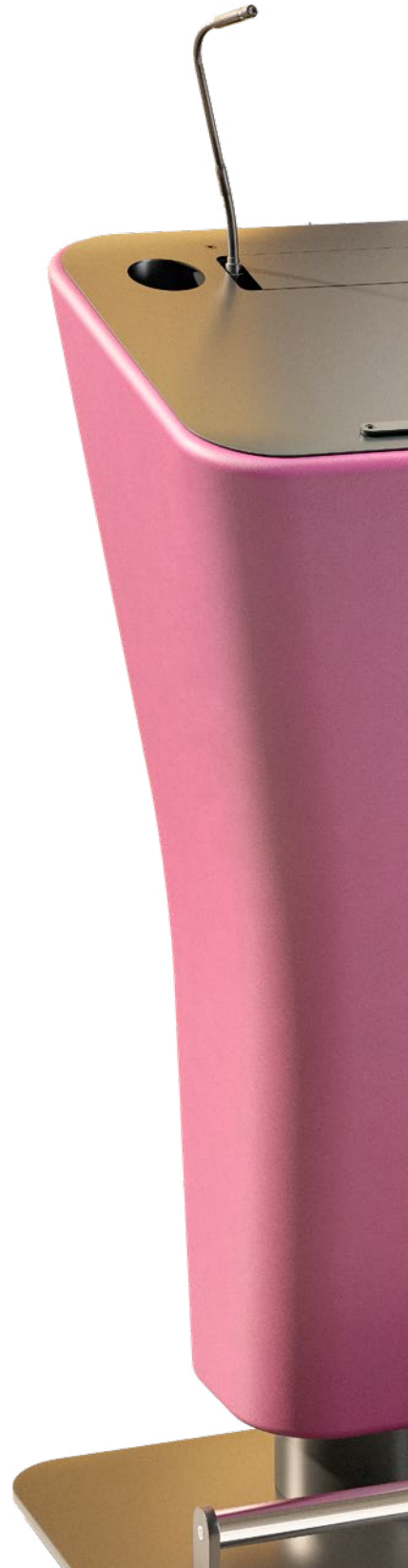

# Osaka

---

by Mar Vaíllo

**It will preside over the meeting room with elegance and comfort, while allowing you to move it from one side to the other thanks to its minimalist, lightweight structure and wheels. The surface of white flattened wood allows the use of dry erase pens and also has a fastening system for paper pads.**

*Il présidera la salle de réunion avec élégance et confort, tout en vous permettant de le déplacer d'un côté à l'autre grâce à sa structure et ses roues minimalistes et légères. La surface en bois laqué blanc permet un effacement à sec, elle dispose également d'un système de fixation pour les blocs de papier.*

Presidirá la sala de reuniones con una elegancia y confortabilidad, a la vez que te permitirá desplazarla de un lado a otro gracias a su estructura minimalista, ligera y con ruedas. La superficie de madera aplacada en blanco permite el borrado en seco, también cuenta con un sistema de sujeción para blocs de papel.

Presiederà la sala di incontri con un'eleganza e conforto, al tempo che ti permetterà di spostarlo da un lato ad un altro grazie alla sua struttura minimalista, leggero e con ruote. La superficie in legno bloccato in bianco consente la cancellazione in secco, ha anche un sistema di bloccaggio per blocchi di carta.









# More about Osaka

DESIGNER

Mar Vaillo

YEAR

2010

LINE SKETCH

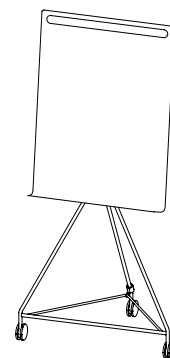

SCALE 10:200 (MM)

PRODUCT

REFERENCE

SIZE



**OSK 01**

81 x 60 x 180 cm  
31,9 x 23,6 x 70,9 in.



PAPER CLIP HOLDING SYSTEM



CURVED DETAIL THAT SERVES AS SUPPORT FOR MARKERS AND ERASER

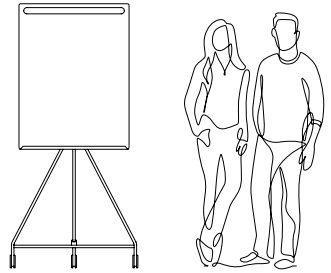

ADJUSTABLE IN HEIGHT - FLAT FOLDING SYSTEM



DRY WRITING BOARD

# Osaka

by Mar Vaíllo

← VIEW PRODUCT PAGES

244

CHARACTERISTICS	CARACTERÍSTICAS	CARACTÉRISTIQUES	CARATTERISTICHE
Mobile white board made from a plywood core topped with a high gloss sheet for writing with dry eraser pens. The bottom of the curved wood serves as a shelf for pens and accessories. Folding structure with wheels, in 16mm stainless steel. Includes paper pad holder.	Pizarra de pié fabricada en núcleo de contrachapado rematado con lámina de alto brillo para la escritura con rotuladores de borrado en seco. La parte inferior de la madera curva sirve de repisa para rotuladores y accesorios. Estructura plegable con ruedas, en tubo de acero inoxidable de Ø16 mm. Incluye soporte para bloc de papel.	Tableau composé d'un noyau de contreplaqué et d'une feuille laminée très brillante permettant d'écrire avec des marqueurs effaçables à sec. La partie inférieure du bois, courbée, sert d'auget pour les marqueurs et les accessoires. Structure pliante à roulettes, en tube d'acier inoxydable de Ø16 mm. Comprend un support pour bloc-notes.	Lavagna bianca mobile realizzata con un nucleo in compensato sormontato da una lamina lucida per scrivere con pennarelli cancellabili a secco. La parte inferiore del legno curvato serve da ripiano per pennarelli e accessori. Struttura pieghevole con ruote, in acciaio inossidabile da Ø16 mm. Include supporto per blocco di carta.

REF	↕↔	📏
 <b>OSK 01</b>	81 x 60 x 180 cm 31,9 x 23,6 x 70,9 in.	10 kg 22 lb.

ENVIRONMENTAL IMPACT				FIRE RESISTANCE	RÉSISTANCE AU FEU
				RESISTENCIA AL FUEGO	RESISTENZA AL FUOCO
Materials may be easily disassembled to be recycled.	Materiales fácilmente segregables para su posterior reciclado.	Matériaux facilement démontables pour leurs recyclages.	Materiali facilmente separabile per un successivo riciclaggio.	UNE-EN 13501-1	D-s2, d0

WARRANTY	GARANTIA	GARANTIE	GARANZIA	PACKAGING	EMBALAJE	EMBALLAGE	IMBALLAGGIO
Two (2) year limited warranty. Does not cover: incorrect use, bad handling or deliberate damage.	Garantía de dos (2) años limitada. No cubre: mal uso, manipulación o daños intencionados.	Garantie deux (2) ans. À l'exception: mauvaise utilisation, manipulation, dommages intentionnés.	Due (2) anni di garanzie limitati. Non copre: uso improprio, manipolazione o danno intenzionale.	Cardboard box with plastic bag for product protection. One package.	Caja de cartón con bolsa de plástico para protección. Un paquete.	Boîte en carton avec sac plastique pour la protection. Un paquet.	Scatola di cartone con sacchetto di plastica per protezione. Un pacco.



COLORS



WOOD + WHITEBOARD

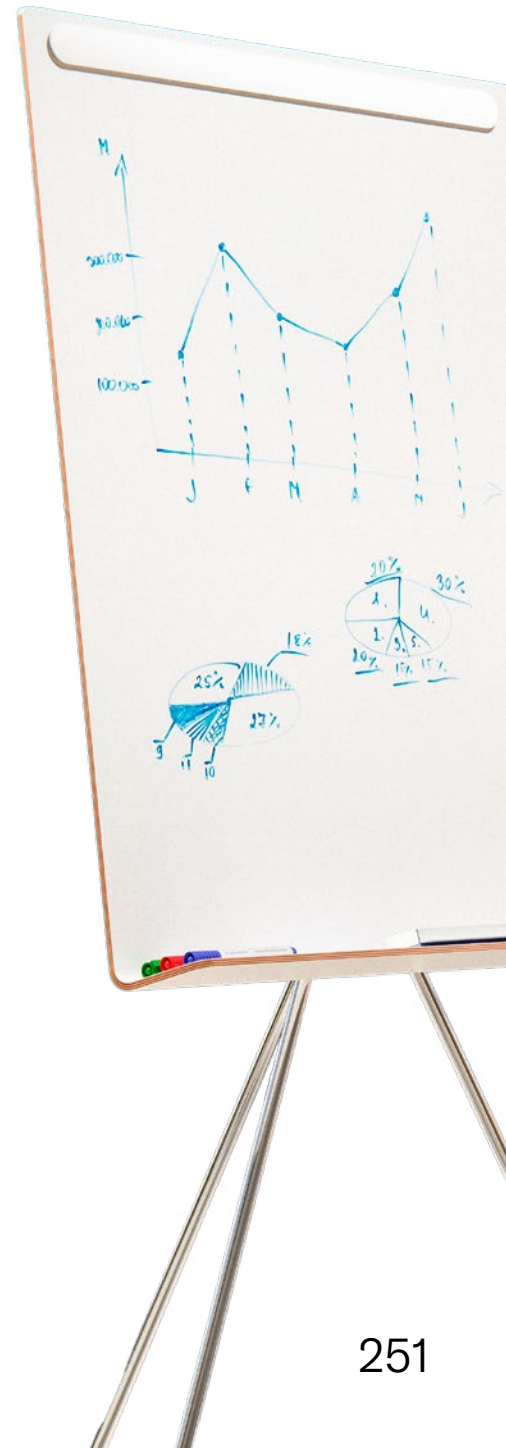

LABELS

Thickness  Ø 16 mm

Material  Inox + Whiteboard

Finish  Lacquered

Conductivity  100%

Acoustic  Doesn't absorb sound

Fire resistance  UNE-EN 13501-1 D-s2, d0

Optimal Space  Indoor

Cleaning  Water & Drying

Weight  10 kg - 22 lb.

# Zao

by Stone Designs

**The new bench that combines a seat and a planter for both indoor and outdoor spaces. Several configurations, multiple colors and the possibility of an upholstered or tropical wood seat. You decide the space and we provide you with a rest area that breathes nature. Get comfortable and breathe.**

*Le nouveau banc qui combine siège et jardinière pour les espaces intérieurs et extérieurs. Différentes configurations, plusieurs couleurs et la possibilité d'un siège rembourré ou en bois. Vous décidez de l'espace et nous vous offrons une zone de repos qui respire la nature. Asseyez-vous et respirez.*

La nueva bancada que combina asiento y jardinera para espacios tanto de interior como exterior. Diversas configuraciones, múltiples colores y posibilidad de asiento tapizado o madera. Tú decides el espacio y nosotros te ponemos un área de descanso que respira a naturaleza. Acomódate, y respira.

La nuova panchina che combina seduta e fioriera per spazi interni ed esterni. Varie configurazioni, molteplici colori e la possibilità di avere una seduta imbottita o in legno. Voi decidete lo spazio e noi vi forniamo un'area di riposo che respira natura. Sedetevi e respirate.











# More about Zao

DESIGNER

Stone Designs

YEAR

2023

LINE SKETCH

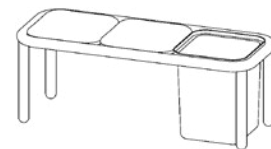

SCALE 1:40 (cm)

PRODUCT

REFERENCE

SIZE



**ZAO 02**  
\*STRUCTURE ONLY

85 x 47,5 x 45 cm  
33,4 x 18,7 x 17,7 in.

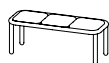

**ZAO 03**  
\*STRUCTURE ONLY

122,5 x 47,5 x 45 cm  
48,2 x 18,7 x 17,7 in.

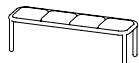

**ZAO 04**  
\*STRUCTURE ONLY

160 x 47,5 x 45 cm  
63 x 18,7 x 17,7 in.

PRODUCT

REFERENCE

SIZE



**ZAO 04C**  
\*STRUCTURE ONLY

85 x 85 x 45 cm  
33,4 x 33,4 x 17,7 in.

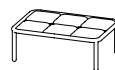

**ZAO 06**  
\*STRUCTURE ONLY

122,5 x 85 x 45 cm  
48,2 x 33,4 x 17,7 in.



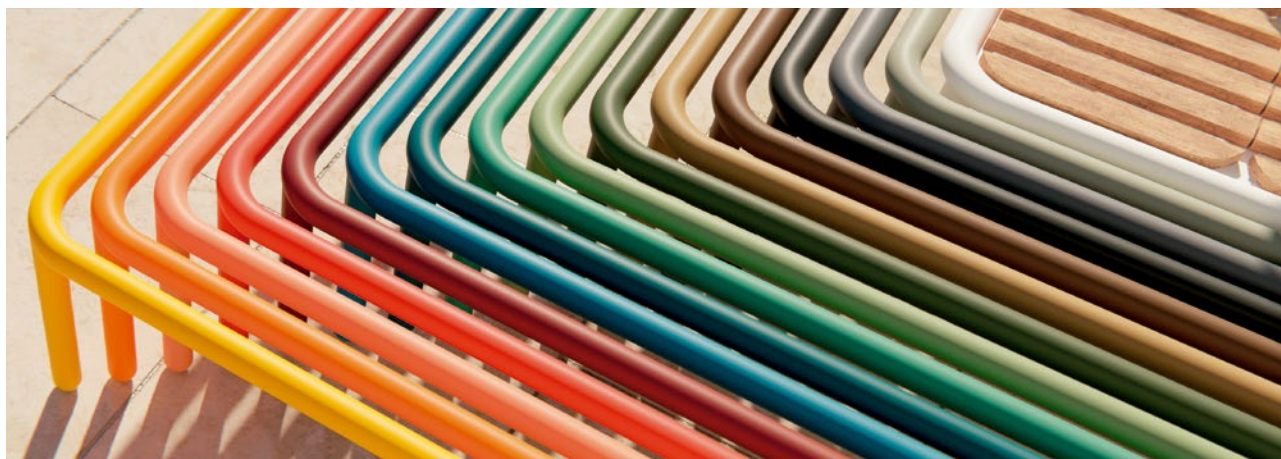

**ZAO 09**  
\*STRUCTURE ONLY

122,5 x 122,5 x 45 cm  
48,2 x 48,2 x 17,7 in.



TEXTIL / WOOD - RANGE 16 COLORS

PRODUCT	REFERENCE	SIZE
	<b>ZAO 15</b> *PLANTER 50 L / 13,2 G	37 x 37 x 45 cm 14,5 x 14,5 x 17,7 in.
	<b>ZAO 20</b> *TEXTIL	37 x 37 x 5 cm 14,5 x 14,5 x 1,9 in.
	<b>ZAO 25</b> *WOOD	37 x 37 x 3 cm 14,5 x 14,5 x 1,2 in.

\*CHOOSE YOUR COMBINATION

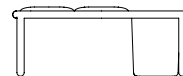

DIFFERENT COMBINATIONS









# Zao

by Stone Designs

← VIEW PRODUCT PAGES

252

CHARACTERISTICS	CARACTERÍSTICAS	CARACTÉRISTIQUES	CARATTERISTICHE
Bench made of steel tube Ø 50 mm and joined by welding. The planter module is made of steel. The seat module is made of wood, water resistant. And the cushion, with fabric for outdoors and easy to clean. Available in different combinations.	Banco fabricado en tubo de acero de Ø 50 mm y unido mediante soldadura. El módulo jardinera está fabricada en acero. El módulo asiento está fabricado con madera, resistente al agua. Y el cojín, con tela para exterior y fácil de limpiar. Disponible en diversas combinaciones.	<i>Banc fabriqué en tube d'acier de Ø 50 mm et soudé. Le module de plantation est en acier. Le module d'assise est en bois résistant à l'eau. Le coussin est en tissu d'extérieur, facile à nettoyer. Disponible en différentes combinaisons.</i>	<i>Panchina realizzata in tubo d'acciaio Ø 50 mm e saldata tra loro. Il modulo della fioriera è in acciaio. Il modulo di seduta è in legno resistente all'acqua. Il cuscino è in tessuto per esterni, facile da pulire. Disponibile in varie combinazioni.</i>

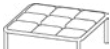
	REF	↕↔	📏		REF	↕↔	📏
	<b>ZAO 02</b> *STRUCTURE ONLY	85 x 47,5 x 45 cm 33,4 x 18,7 x 17,7 in	8,2 kg 18 lb.		<b>ZAO 15</b> *PLANTER 50 L / 13,2 G	37 x 37 x 45 cm 14,5 x 14,5 x 17,7 in	8 kg 17,6 lb.
	<b>ZAO 03</b> *STRUCTURE ONLY	122,5 x 47,5 x 45 cm 48,2 x 18,7 x 17,7 in	11,6 kg 25,5 lb.		<b>ZAO 20</b> *TEXTIL	37 x 37 x 5 cm 14,5 x 14,5 x 1,9 in	1,8 kg 4 lb.
	<b>ZAO 04</b> *STRUCTURE ONLY	160 x 47,5 x 45 cm 63 x 18,7 x 17,7 in	15,5 kg 34,1 lb.		<b>ZAO 25</b> *WOOD	37 x 37 x 3 cm 14,5 x 14,5 x 1,2 in	2,5 kg 5,11 lb.
	<b>ZAO 04C</b> *STRUCTURE ONLY	85 x 85 x 45 cm 33,4 x 33,4 x 17,7 in	15,5 kg 34,1 lb.	*CHOOSE YOUR COMBINATION			
	<b>ZAO 06</b> *STRUCTURE ONLY	122,5 x 85 x 45 cm 48,2 x 33,4 x 17,7 in	17,2 kg 37,9 lb.				
	<b>ZAO 09</b> *STRUCTURE ONLY	122,5 x 122,5 x 45 cm 48,2 x 48,2 x 17,7 in	18,9 kg 41,6 lb.				

























ENVIRONMENTAL IMPACT				FIRE RESISTANCE	RÉSISTANCE AU FEU
				RESISTENCIA AL FUEGO	RESISTENZA AL FUOCO
Materials may be easily disassembled to be recycled.	Materiales fácilmente segregables para su posterior reciclado.	<i>Matériaux facilement démontables pour leurs recyclages.</i>	<i>Materiali facilmente separabile per un successivo riciclaggio.</i>	UNE-EN 13501-1	A1-s1, d0

WARRANTY	GARANTIA	GARANTIE	GARANZIA	PACKAGING	EMBALAJE	EMBALLAGE	IMBALLAGGIO
Two (2) year limited warranty. Does not cover: incorrect use, bad handling or deliberate damage.	Garantía de dos (2) años limitada. No cubre: mal uso, manipulación o daños intencionados.	<i>Garantie deux (2) ans. À l'exception: mauvaise utilisation, manipulation, dommages intentionnés.</i>	<i>Due (2) anni di garanzie limitati. Non copre: uso improprio, manipolazione o danno intenzionale.</i>	Cardboard box with plastic bag for product protection. One package.	Caja de cartón con bolsa de plástico para protección. Un paquete.	<i>Boîte en carton avec sac plastique pour la protection. Un paquet.</i>	<i>Scatola di cartone con sacchetto di plastica per protezione. Un pacco.</i>



BRAND COLORS

TEXTILE COLORS

 BL · Ral 9003	 VD · Ral 6000	 VDC · FEROE 160
 CE · Ral 7033	 PE · Ral 5020	 VDO · PATTAY 90
 GR · Ral 7015	 AZ · Ral 5009	 AZC · FEROE 190
 AN · Ral 7016	 BD · Ral 3005	 GR · FEROE 280
 MA · Ral 8014	 RJ · Ral 3020	 RS · FEROE 90
 OP · Ral 1036	 RS · Ral 2012	 RJ · PATTAY 60
 VF · Ral 6020	 AM · Ral 1007	 BD · CAPRI 150
 VO · Ral 6011	 NJ · Ral 2017	 AZO · MADEIRA 390

CUSTOMIZE OPTIONS









PERSONNALISER LES OPTIONS

OPCIONES PERSONALIZADAS

OPZIONI DI PERSONALIZZAZIONE



LABELS

Thickness  Ø 50 mm	Acoustic  Doesn't absorb sound
Material  Steel + Textile or Wood	Fire resistance  UNE-EN 13501-1 A1-s1, d0
Finish  Lacquered + Fabrics	Optimal Space  Indoor / Outdoor
Conductivity  100%	Cleaning  Water & Drying
	Weight  See page 290



# Niseko

by Ferran Guimerà

**Modular system of configurable seats ideal for interior open spaces. Thanks to the trapezoidal shape of its single piece, it can be adapted to any space according to each need. The module can become an upholstered seat, planter or recycling container. Its optional side table combines with the set and provides functionality.**

*Système de sièges modulaires configurables idéal pour les espaces ouverts intérieurs. Grâce à la forme trapézoïdale de sa pièce unique, il peut être adapté à n'importe quel espace en fonction de chaque besoin. Le module peut être transformé en siège rembourré, en jardinière ou en poubelle de recyclage. Sa table d'appoint optionnelle se combine avec l'ensemble et ajoute de la fonctionnalité.*

Sistema modular de asiento configurable ideal para espacios abiertos interiores. Gracias a la forma trapezoidal de su única pieza permite adaptarse a cualquier espacio según cada necesidad. El módulo puede convertirse en asiento tapizado, jardinera o contenedor de reciclaje. Su mesita auxiliar opcional combina con el conjunto y aporta funcionalidad.

Sistema di sedute modulari configurabili ideale per gli spazi aperti interni. Grazie alla forma trapezoidale del suo singolo pezzo, può essere adattato a qualsiasi spazio in base alle esigenze. Il modulo può essere trasformato in una seduta imbottita, in una fioriera o in un contenitore per il riciclaggio. Il tavolino opzionale si abbina al set e aggiunge funzionalità.

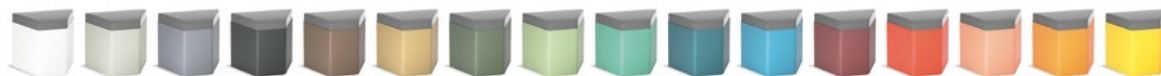









# More about Niseko

DESIGNER

Ferran Guimerà

YEAR

2023

PRODUCT

REFERENCE

SIZE



**NSK 10**

56 x 35 x 40 cm  
22 x 13,7 x 15,7 in.



**NSK 15**  
\*TEXTIL

56 x 35 x 10 cm  
22 x 13,7 x 3,9 in.



**NSK 20**  
\*PLANTER

56 x 35 x 40 cm  
22 x 13,7 x 15,7 in.

LINE SKETCH

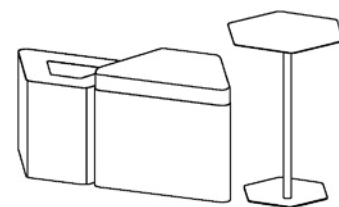

SCALE 1:40 (cm)

PRODUCT

REFERENCE

SIZE



**NSK 30**  
\*TRASH

56 x 35 x 40 cm  
22 x 13,7 x 15,7 in.



**NSK 40**

49 x 43 x 66 cm  
19,3 x 17 x 26 in.



TEXTIL SEATS / TABLE, WASTEBASKET, PLANTER AND SEAT



DIFFERENT COMBINATIONS

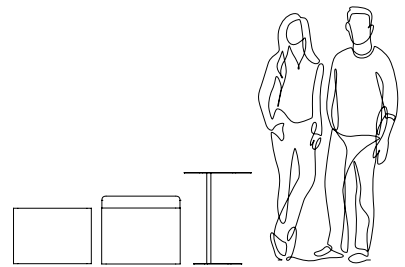

RANGE 16 COLORS / RANGE 8 TEXTIL COLORS





# Niseko

by Ferran Guimerà

← VIEW PRODUCT PAGES

260

CHARACTERISTICS	CARACTERÍSTICAS	CARACTÉRISTIQUES	CARATTERISTICHE
Trapezoidal module in 1.5 mm thick sheet metal, with two 2 mm rings welded to the body. They are placed, one at the bottom and one at the top, to fix the cushion modules and the covers. The cushion made of outdoor fabric is screwed to the module. The litter bin version has a lid and the planter version has a two-part lid.	Módulo trapezoidal en chapa metálica de 1,5 mm de grosor, con dos aros de 2mm soldados al cuerpo. Se ubican, uno en la parte inferior y otro en la parte superior, para fijar los módulos del cojín y las tapas. El cojín fabricado de tejido para exterior se atornilla al módulo. La versión papelera dispone de tapa y la versión jardinera de tapa en dos partes.	<i>Module trapézoïdal en tôle de 1,5 mm d'épaisseur, avec deux anneaux de 2 mm soudés au corps. Ils sont placés, l'un en bas et l'autre en haut, pour fixer les modules de coussins et les housses. Le coussin en tissu d'extérieur est vissé au module. La version poubelle est munie d'un couvercle et la version jardinière d'un couvercle en deux parties.</i>	<i>Modulo trapezoidale in lamiera di 1,5 mm di spessore, con due anelli da 2 mm saldati al corpo. Vengono posizionati, uno in basso e uno in alto, per fissare i moduli dei cuscini e le coperture. Il cuscino in tessuto per esterni è avvitato al modulo. La versione cestino ha un coperchio, mentre la versione fioriera ha un coperchio in due parti.</i>

	REF	↕↔	⚖
	<b>NSK 10</b>	56 x 35 x 40 cm 22 x 13,7 x 15,7 in	10,2 kg 22,4 lb.
	<b>NSK 15</b> *TEXTIL	56 x 35 x 10 cm 22 x 13,7 x 3,9 in	2,2 kg 4,8 lb.
	<b>NSK 20</b> *PLANTER	56 x 35 x 40 cm 22 x 13,7 x 15,7 in	13,1 kg 28,8 lb.
	<b>NSK 30</b> *TRASH	56 x 35 x 40 cm 22 x 13,7 x 15,7 in	13,1 kg 28,8 lb.
	<b>NSK 40</b> *TABLE	49 x 43 x 66 cm 19,3 x 17 x 26 in	7,5 kg 16,5 lb.



ENVIRONMENTAL IMPACT				FIRE RESISTANCE	RÉSISTANCE AU FEU
				RESISTENCIA AL FUEGO	RESISTENZA AL FUOCO
Materials may be easily disassembled to be recycled.	Materiales fácilmente segregables para su posterior reciclado.	<i>Matériaux facilement démontables pour leurs recyclages.</i>	<i>Materiali facilmente separabile per un successivo riciclaggio.</i>	UNE-EN 13501-1	A1-s1, d0

WARRANTY	GARANTIA	GARANTIE	GARANZIA	PACKAGING	EMBALAJE	EMBALLAGE	IMBALLAGGIO
Two (2) year limited warranty. Does not cover: incorrect use, bad handling or deliberate damage.	Garantía de dos (2) años limitada. No cubre: mal uso, manipulación o daños intencionados.	<i>Garantie deux (2) ans. À l'exception: mauvaise utilisation, manipulation, dommages intentionnés.</i>	<i>Due (2) anni di garanzie limitati. Non copre: uso improprio, manipolazione o danno intenzionale.</i>	Cardboard box with plastic bag for product protection. One package.	Caja de cartón con bolsa de plástico para protección. Un paquete.	<i>Boîte en carton avec sac plastique pour la protection. Un paquet.</i>	<i>Scatola di cartone con sacchetto di plastica per protezione. Un pacco.</i>



BRAND COLORS

-  BL · Ral 9003
-  CE · Ral 7033
-  GR · Ral 7015
-  AN · Ral 7016
-  MA · Ral 8014
-  OP · Ral 1036
-  VF · Ral 6020
-  VO · Ral 6011

-  VD · Ral 6000
-  PE · Ral 5020
-  AZ · Ral 5009
-  BD · Ral 3005
-  RJ · Ral 3020
-  RS · Ral 2012
-  AM · Ral 1007
-  NJ · Ral 2017



TEXTILE COLORS

-  VDC · FEROE 160
-  VDO · PATTAY 90
-  AZC · FEROE 190
-  GR · FEROE 280
-  RS · FEROE 90
-  RJ · PATTAY 60
-  BD · CAPRI 150
-  AZO · MADEIRA 390

CUSTOMIZE OPTIONS

OPCIONES PERSONALIZADAS

PERSONNALISER LES OPTIONS

OPZIONI DI PERSONALIZZAZIONE



LABELS

Thickness  1,5 mm

Material  Steel + Fabrics

Finish  Lacquered

Conductivity  100%

Acoustic  Doesn't absorb sound

Fire resistance  UNE-EN 13501-1 A1-s1, d0

Optimal Space  Indoor

Cleaning  Water & Drying

Weight  See page 298



# Menfis

---

by Mario Ruiz

**This range of minimalist signage makes the message relevant; it's almost invisible form is perfect for all types of public or private buildings. For wall, desktop, free standing, hanging and projected it's a modular system with custom size, allows you to adapt to all your needs.**

*Cette gamme de signalétique minimaliste rend le message pertinent, sa forme presque invisible est parfaite pour tous les types de bâtiments publics ou privés. Sur le mur, le bureau, debout, suspendu et projeté, il s'agit d'un système modulaire à la taille personnalisée, il permet de s'adapter à tous les besoins.*

Esta gama de señalética minimalista hace relevante el mensaje, su forma casi invisible es perfecta para todo tipo de edificios públicos o privados. Para pared, sobremesa, de pie, colgante y proyectado y un sistema modular con tamaño personalizado, le permite adaptarse a todas las necesidades.

Questa gamma di segnaletica il minimalista rende rilevante il messaggio, la sua forma quasi invisibile è perfetto per tutti i tipi di edifici pubblici o privati. Da parete, da tavolo, da appoggio, sospeso e proiettato e un sistema modulare con un formato personalizzato, gli permette di adattarsi a tutte le necessità.

FLOOR 3  
A4

WORK AREA

7  
GROUP

Mr. Menfis



Studio 2



Silence



Wait



Meeting Room





ing area

 made4u

floor 5 Terrace

floor 4 Dining area

floor 3 I+D

floor 2 Design room

floor 1 Convention hall

floor 0 Main entrance

 made4u

Welcome

 Director



# More about Menfis

DESIGNER

Mario Ruiz

YEAR

2010

LINE SKETCH

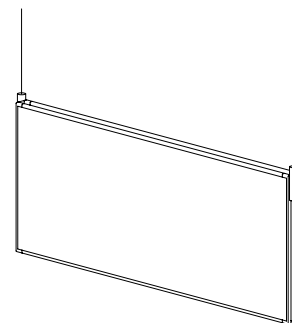

SCALE 1:10 (cm)

PRODUCT

REFERENCE

SIZE

WALL MOUNT



MEN 01

MEN 02

MEN 03



MEN 04

	x	5	7	10,5	21	29,7	32	48	64	72	96	cm
	x	2	2,7	4,1	8,3	11,7	12,6	18,9	25,2	28,3	37,8	in.
MEN 01	5,25 2,1		•	•	•	•	•	•	•	•	•	
MEN 02	7 2,7		•	•	•	•	•	•	•	•	•	
MEN 03	10,5 4,1			•	•	•	•	•	•	•	•	
MEN 04	21 8,3				•	•	•	•	•	•	•	

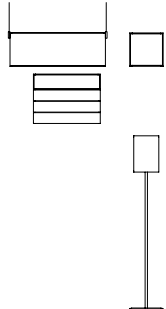

HANGING SUPPORT – MEN 21

PRODUCT	REFERENCE	SIZE												
<b>PROJECTED</b> 			x	5	7	10,5	21	29,7	32	48	64	72	96	cm
			x	2	2,7	4,1	8,3	11,7	12,6	18,9	25,2	28,3	37,8	in.
	<b>MEN 11</b>	10,5 4,1					•	•						
	<b>MEN 12</b>	21 8,3					•	•						



COMPOSITION WITH WALL SUPPORT — MEN 01 + MEN 03

# More about Memphis

DESIGNER

Mario Ruiz

YEAR

2010

LINE SKETCH

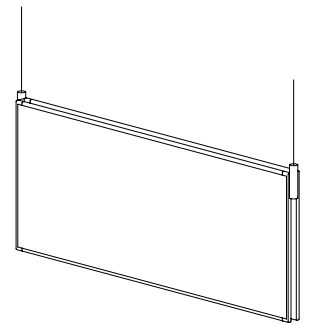

SCALE 1:10 (cm)

PRODUCT

REFERENCE

SIZE

HANG

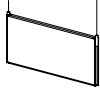

MEN 21

x	5	7	10,5	21	29,7	32	48	64	72	96	cm
x	2	2,7	4,1	8,3	11,7	12,6	18,9	25,2	28,3	37,8	in.
	21						•	•	•	•	
	8,3										

DESK



MEN 31

MEN 32

MEN 33

MEN 34

x	5	7	10,5	21	29,7	32	48	64	72	96	cm
x	2	2,7	4,1	8,3	11,7	12,6	18,9	25,2	28,3	37,8	in.
	5,25		•	•							
	2,1										
	7		•	•							
	2,7										
	10,5		•	•							
	4,1										
	21			•	•						
	8,3										



DESKTOP SUPPORT – MEN 31

PRODUCT	REFERENCE	SIZE											
STAND 		x	5	7	10,5	21	29,7	32	48	64	72	96	cm
		x	2	2,7	4,1	8,3	11,7	12,6	18,9	25,2	28,3	37,8	in.
	MEN 41		21			•	•						
			8,3										

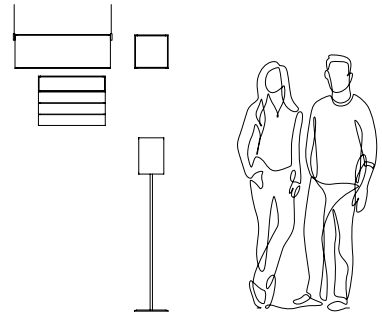

STANDING SUPPORT DETAIL – MEN 41

# Menfis

by Mario Ruiz

← VIEW PRODUCT PAGES

268

## CHARACTERISTICS

Signage system made using white lacquered extruded aluminium. The side caps are injected into zamak. Available in 4 height sizes and variable width as required. Covered using transparent plastic sheets that protect the signage. Suction cup is supplied for document extraction. Wall fixing using rawplugs and screws or double-sided adhesive.

## CARACTERÍSTICAS



Sistema de señalización fabricado en aluminio extrusionado y lacado en blanco. Las tapas laterales están inyectadas en zamak. Disponible en 4 tamaños de altura y de anchura variable según necesidad. Lámina plástica transparente que protege el papel con la indicación. Se suministra ventosa para extracción del documento. Fijación a pared mediante taco y tornillo o adhesivo doble cara.

## CARACTÉRISTIQUES

Système de signalétique en aluminium extrudé et laqué blanc. Les parties latérales sont injectés en zamak. Disponible en 4 hauteur différentes et de largeur variable selon les besoins. Feuille de plastique transparente qui protège le papier avec l'indication. Une ventouse est fournie pour l'extraction des documents. Fixation au mur à l'aide de cheville et vis ou d'un adhésif double face.

## CARATTERISTICHE

Sistema di segnalazione realizzato in alluminio estruso e laccato bianco. Le coperture laterali sono iniettate in zamak. Disponibile in 4 misure di altezza e larghezza variabile a seconda delle necessità. Pellicola di plastica trasparente che protegge la carta con l'indicazione. Viene fornita una ventosa per l'estrazione dei documenti.. Fissaggio a parete con tassello e vite o biadesivo.

	REF	↕↔	📏		REF	↕↔	📏
 WALL	<b>MEN 01 21</b>	21 x 21 cm	0,4 kg / 0,9 lb.	 HANGED	<b>MEN 04 07</b>	7 x 5,25 cm	0,1 kg / 0,2 lb.
	<b>MEN 01 29</b>	29,7 x 21 cm	0,6 kg / 1,3 lb.		<b>MEN 04 10</b>	10,5 x 5,25 cm	0,1 kg / 0,2 lb.
	<b>MEN 01 32</b>	32 x 21 cm	0,6 kg / 1,3 lb.		<b>MEN 04 21</b>	21 x 5,25 cm	0,1 kg / 0,2 lb.
	<b>MEN 01 48</b>	48 x 21 cm	0,9 kg / 2 lb.		<b>MEN 04 32</b>	32 x 5,25 cm	0,2 kg / 0,4 lb.
	<b>MEN 01 64</b>	64 x 21 cm	1,2 kg / 2,6 lb.		<b>MEN 04 48</b>	48 x 5,25 cm	0,2 kg / 0,4 lb.
	<b>MEN 01 72</b>	72 x 21 cm	1,3 kg / 2,9 lb.		<b>MEN 04 64</b>	64 x 5,25 cm	0,3 kg / 0,7 lb.
	<b>MEN 01 96</b>	96 x 21 cm	1,7 kg / 3,7 lb.		<b>MEN 04 72</b>	72 x 5,25 cm	0,3 kg / 0,7 lb.
	<b>MEN 02 10</b>	10,5 x 10,5 cm	0,1 kg / 0,2 lb.		<b>MEN 04 96</b>	96 x 5,25 cm	0,4 kg / 0,9 lb.
	<b>MEN 02 21</b>	21 x 10,5 cm	0,2 kg / 0,4 lb.		<b>MEN 21 48</b>	48 x 21 cm	1,8 kg / 4 lb.
	<b>MEN 02 32</b>	32 x 10,5 cm	0,3 kg / 0,7 lb.		<b>MEN 21 64</b>	64 x 21 cm	2,4 kg / 5,3 lb.
	<b>MEN 02 48</b>	48 x 10,5 cm	0,4 kg / 0,9 lb.		<b>MEN 21 72</b>	72 x 21 cm	2,6 kg / 5,7 lb.
	<b>MEN 02 64</b>	64 x 10,5 cm	0,5 kg / 1,1 lb.		<b>MEN 21 96</b>	96 x 21 cm	3,4 kg / 7,5 lb.
	<b>MEN 02 72</b>	72 x 10,5 cm	0,6 kg / 1,3 lb.		<b>MEN 31 21</b>	21 x 21 cm	0,6 kg / 1,3 lb.
	<b>MEN 02 96</b>	96 x 10,5 cm	0,7 kg / 1,5 lb.		<b>MEN 31 29</b>	29,7 x 21 cm	0,7 kg / 1,5 lb.
	<b>MEN 03 07</b>	7 x 7 cm	0,1 kg / 0,2 lb.		<b>MEN 32 10</b>	10,5 x 10,5 cm	0,2 kg / 0,4 lb.
	<b>MEN 03 10</b>	10,5 x 7 cm	0,1 kg / 0,2 lb.		<b>MEN 32 21</b>	21 x 10,5 cm	0,3 kg / 0,7 lb.
<b>MEN 03 21</b>	21 x 7 cm	0,2 kg / 0,4 lb.	<b>MEN 33 10</b>	10,5 x 7 cm	0,1 kg / 0,2 lb.		
<b>MEN 03 32</b>	32 x 7 cm	0,3 kg / 0,7 lb.	<b>MEN 33 21</b>	21 x 7 cm	0,7 kg / 1,5 lb.		
<b>MEN 03 48</b>	48 x 7 cm	0,4 kg / 0,9 lb.	<b>MEN 34 10</b>	10,5 x 5,25 cm	0,1 kg / 0,2 lb.		
<b>MEN 03 64</b>	64 x 7 cm	0,5 kg / 1,1 lb.	<b>MEN 34 21</b>	21 x 5,25 cm	0,2 kg / 0,4 lb.		
<b>MEN 03 72</b>	72 x 7 cm	0,6 kg / 1,3 lb.	<b>MEN 41 21</b>	21 x 21 cm	8 kg / 17,6 lb.		
<b>MEN 03 96</b>	96 x 7 cm	0,7 kg / 1,5 lb.	<b>MEN 41 29</b>	21 x 29,7 cm	8,2 kg / 18,1 lb.		
 PROJECTED	<b>MEN 11 21</b>	21 x 21 cm	8,2 kg / 8,2 lb.				
	<b>MEN 11 29</b>	29,7 x 21 cm	11,7 kg / 8,2 lb.				
	<b>MEN 12 21</b>	21 x 10,5 cm	8,2 kg / 4,1 lb.				
	<b>MEN 12 29</b>	29,7 x 10,5 cm	0,3 kg / 0,7 lb.				

## ENVIRONMENTAL IMPACT

Materials may be easily disassembled to be recycled.

Materiales fácilmente segregables para su posterior reciclado.

*Matériaux facilement démontables pour leurs recyclages.*

*Materiali facilmente separabile per un successivo riciclaggio.*

## FIRE RESISTANCE

RESISTENCIA AL FUEGO

UNE-EN 13501-1

## RÉSISTANCE AU FEU

RESISTENZA AL FUOCO

A1-s1, d0

## WARRANTY

Two (2) year limited warranty. Does not cover: incorrect use, bad handling or deliberate damage.

## GARANTIA

Garantía de dos (2) años limitada. No cubre: mal uso, manipulación o daños intencionados.

## GARANTIE

*Garantie deux (2) ans. À l'exception: mauvaise utilisation, manipulation, dommages intentionnés.*

## GARANZIA

*Due (2) anni di garanzie limitati. Non copre: uso improprio, manipolazione o danno intenzionale.*

## PACKAGING

Cardboard box with plastic bag for product protection. One package.

## EMBALAJE

Caja de cartón con bolsa de plástico para protección. Un paquete.

## EMBALLAGE

*Boîte en carton avec sac plastique pour la protection. Un paquet.*

## IMBALLAGGIO

*Scatola di cartone con sacchetto di plastica per protezione. Un pacco.*

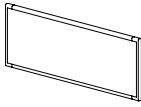

BRAND COLORS



BL · Ral 9003



LABELS

Thickness		1,5 mm	Acoustic		Doesn't absorb sound
Material		Aluminium	Fire resistance		UNE-EN 13501-1 A1-s1, d0
Finish		Lacquered	Optimal Space		Indoor
Conductivity		100%	Cleaning		Water & Drying
			Weight		See page 308

# Linear

by MD Design Lab

**Linear is a very minimalist and functional collection of area boundary posts. To delimit the spaces, it has an elastic band that is cut to size to achieve the desired measurement. Available in 16 and 4 colors respectively.**

Linear es una colección de postes delimitadores de áreas muy minimalista y funcional. Para delimitar los espacios, dispone de una goma elástica que se corta a medida para conseguir así la medida deseada. Disponible en 16 y 4 colores respectivamente.

*Linear est une collection très minimaliste et fonctionnelle de poteaux de délimitation de zone. Pour délimiter les espaces, il dispose d'un élastique découpé sur mesure pour obtenir la mesure souhaitée. Disponible en 16 et 4 couleurs respectivement.*

**Linear è una collezione molto minimalista e funzionale di pali di delimitazione delle aree. Per delimitare gli spazi è dotata di una fascia elastica che viene tagliata su misura per ottenere la misura desiderata. Disponibili rispettivamente in 16 e 4 colori.**











# More about Linear

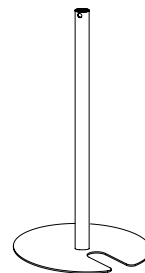

SCALE 1:40 (cm)

DESIGNER

MD Lab

YEAR

2024

LINE SKETCH

PRODUCT

REFERENCE

SIZE



**LIN/45**

Ø36 x 45 cm  
17,7 in.



**LIN/90**

Ø36 x 90 cm  
35,4 in.



**LIN/90 D**

Ø36 x 90 cm  
35,4 in.



**LIN/TER**

ø 1,8 x 1,9 cm  
ø 0,7 x 0,7 in.

PRODUCT

REFERENCE

SIZE



**LIN/GO/20**

200 cm  
78,7 in.



**LIN/GO/25**

250 cm  
98,4 in.



**LIN/GO/50**



500 cm  
196,8 in.

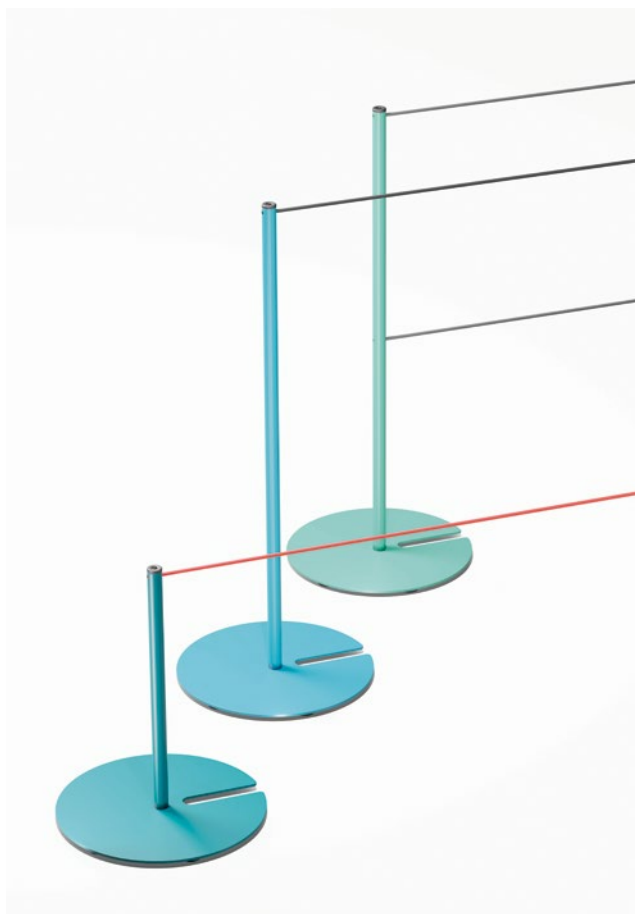

**LIN/GO/500**

5000 cm  
1968,5 in.



PRODUCT	REFERENCE	SIZE
	<b>LIN/PC A4V</b>	37 x 22,5 cm 14,5 x 8,8 in.
	<b>LIN/PC A4H</b>	32,5 x 32 cm 12,8 x 12,6 in.

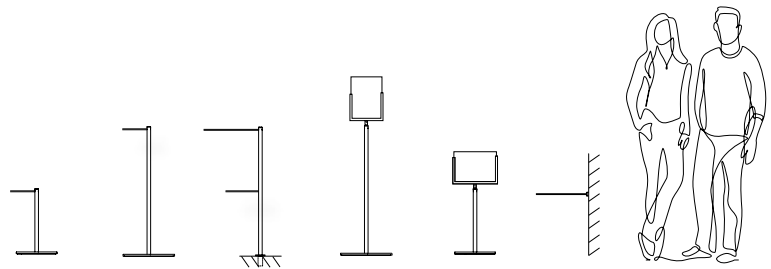













# Linear

by MD Design Lab

← VIEW PRODUCT PAGES

278

CHARACTERISTICS	CARACTERÍSTICAS	CARACTÉRISTIQUES	CARATTERISTICHE
Separator post made of 2.5 cm diameter steel tube of 90 and 45 cm. high and metal base of 36 cm. epoxy lacquered. The 6mm thick elastic cord is required to place between the delimiters. The cord is available in different lengths or in a 25 meter coil. The range includes metal and methacrylate sign holders.	Poste separador fabricado en tubo de acero de 2,5 cm de diámetro de 90 y 45 cm. de altura y base metálica de 36 cm. lacada epoxi. El cordón elástico de 6 mm de grosor es necesario para colocar entre los delimitadores. El cordón está disponible en distintos largos o en bobina de 25 metros. La gama incorpora portacarteles metálicos y metacrilato.	<i>Poteau séparateur en tube d'acier de 2,5 cm de diamètre de 90 et 45 cm. haut et base en métal de 36 cm. laqué époxy. Le cordon élastique de 6 mm d'épaisseur est à placer entre les délimiteurs. Le cordon est disponible en différentes longueurs ou en bobine de 25 mètres. La gamme comprend des porte-affiches en métal et en méthacrylate.</i>	<i>Palo separatore realizzato in tubo d'acciaio di diametro 2,5 cm da 90 e 45 cm. di altezza e base in metallo di 36 cm. laccato epossidico. È necessario posizionare il cordino elastico spesso 6 mm tra i delimitatori. Il cavo è disponibile in diverse lunghezze o in bobina da 25 metri. La gamma comprende porta segnaletica in metallo e metacrilato.</i>

	REF	↕↔			REF	↕↔	
	LIN/45	45 cm 17,7 in.	6 kg 13,2 lb.		LIN/GO/50	500 cm 196,8 in.	
	LIN/90	90 cm 35,4 in.	8 kg 17,6 lb.		LIN/GO/500	5000 cm 1968,5 in.	
	LIN/90 D	90 cm 35,4 in.	8 kg 17,6 lb.		LIN/PC A4V	22 x 24 cm 8,6 x 9,4 in.	0,5 kg 1,1 lb.
	LIN/TER	ø 1,8 x 1,9 cm ø 0,7 x 0,7 in.	0,1 kg 0,2 lb.		LIN/PC A4H	31 x 22 cm 12,2 x 8,6 in.	0,5 kg 1,1 lb.
	LIN/GO/20	200 cm 78,7 in.					
	LIN/GO/25	250 cm 98,4 in.					

ENVIRONMENTAL IMPACT				FIRE RESISTANCE	RÉSISTANCE AU FEU
				RESISTENCIA AL FUEGO	RESISTENZA AL FUOCO
Materials may be easily disassembled to be recycled.	Materiales fácilmente segregables para su posterior reciclado.	<i>Matériaux facilement démontables pour leurs recyclages.</i>	<i>Materiali facilmente separabile per un successivo riciclaggio.</i>	UNE-EN 13501-1	A1-s1, d0





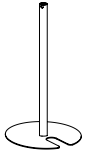















WARRANTY	GARANTIA	GARANTIE	GARANZIA	PACKAGING	EMBALAJE	EMBALLAGE	IMBALLAGGIO
Two (2) year limited warranty. Does not cover: incorrect use, bad handling or deliberate damage.	Garantía de dos (2) años limitada. No cubre: mal uso, manipulación o daños intencionados.	<i>Garantie deux (2) ans. À l'exception: mauvaise utilisation, manipulation, dommages intentionnés.</i>	<i>Due (2) anni di garanzie limitati. Non copre: uso improprio, manipolazione o danno intenzionale.</i>	Cardboard box with plastic bag for product protection. One package.	Caja de cartón con bolsa de plástico para protección. Un paquete.	<i>Boîte en carton avec sac plastique pour la protection. Un paquet.</i>	<i>Scatola di cartone con sacchetto di plastica per protezione. Un pacco.</i>

BRAND COLORS



CORD COLORS



 BL · Ral 9003	 VD · Ral 6000	 BL · Ral 9003
 CE · Ral 7033	 PE · Ral 5020	 GR · Ral 7015
 GR · Ral 7015	 AZ · Ral 5009	 RJ · Ral 3020
 AN · Ral 7016	 BD · Ral 3005	 NG · Ral 9005
 MA · Ral 8014	 RJ · Ral 3020	
 OP · Ral 1036	 RS · Ral 2012	
 VF · Ral 6020	 AM · Ral 1007	
 VO · Ral 6011	 NJ · Ral 2017	

CUSTOMIZE OPTIONS









PERSONNALISER LES OPTIONS

OPCIONES PERSONALIZADAS

OPZIONI DI PERSONALIZZAZIONE



LABELS

Thickness  -	Acoustic  Doesn't absorb sound
Material  Iron	Fire resistance  UNE-EN 13501-1 A1-s1, d0
Finish  Lacquered	Optimal Space  Indoor
Conductivity  100%	Cleaning  Water & Drying
	Weight  See page 316

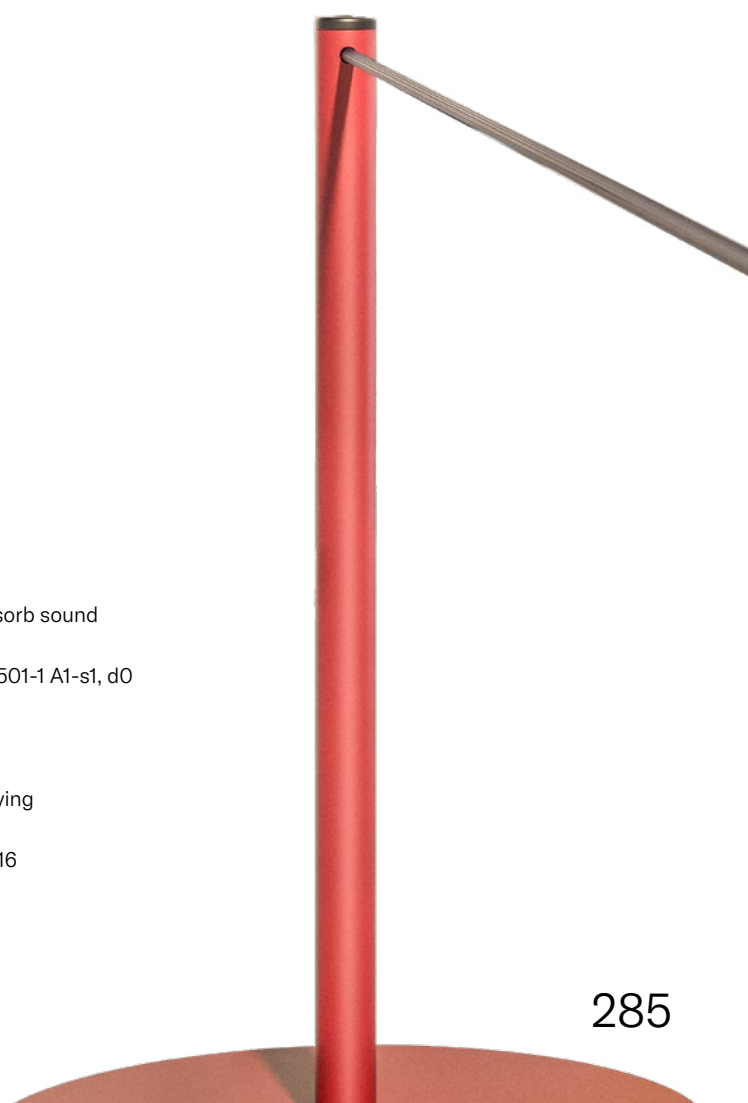

# Sapporo

---

by Toni Pallejà

**It's geometric shape evokes the world of origami. Simple and contemporary this side table is ideal for living rooms and waiting areas. Available in seven attractive colours and made from three millimetre steel.**

Su forma geométrica evoca al mundo de la papiroflexia. Simple y contemporánea esta mesita auxiliar es idónea para salones y áreas de espera. Disponible en siete atractivos colores y fabricada en acero de tres milímetros.

*Sa forme géométrique évoque le monde de l'origami. Simple et contemporaine, cette table d'appoint est idéale pour les salons et les zones d'attente. Disponible en sept couleurs attrayantes et fabriquée en acier de trois millimètres d'épaisseur.*

La sua forma geometrica evoca al mondo degli origami. Semplice e contemporaneo questo il tavolo ausiliario è ideale per salotti e aree di attesa. Disponibile in sette attrazioni colori e realizzato in acciaio inossidabile di tre millimetri.











# More about Sapporo

DESIGNER

Toni Pallejà

YEAR

2007

LINE SKETCH

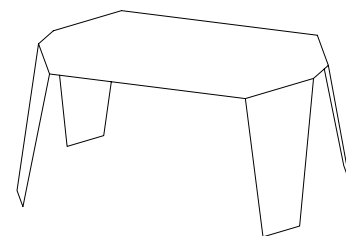

SCALE 1:20 (cm)

PRODUCT

REFERENCE

SIZE



**SPR 01**

58 x 43,3 x 28 cm  
22,8 x 17 x 11 in.



COLOR RANGE

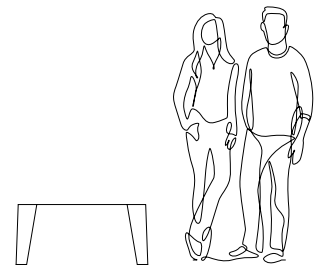

IT'S ALIVE

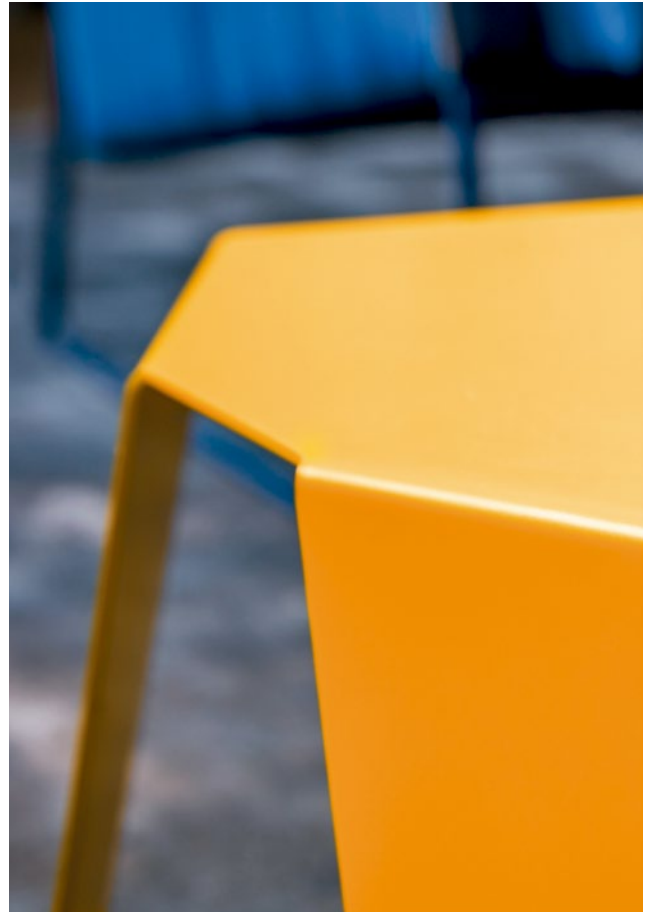



DETAIL VIEW

# Sapporo

by Toni Pallejà

← VIEW PRODUCT PAGES

















286

CHARACTERISTICS	CARACTERÍSTICAS	CARACTÉRISTIQUES	CARATTERISTICHE
Auxiliary table made from 3 mm folded iron. With plastic stoppers on the legs to protect the surface where it is located.	Mesa auxiliar fabricada en chapa de hierro doblada de 3 mm. Con piezas de plástico en las patas para proteger la superficie donde se ubique.	<i>Table auxiliaire fabriquée en tôle pliée de 3 mm d'épaisseur. Avec des pièces en plastique sous les pieds pour protéger la surface où elle se trouve.</i>	<i>Tavolo ausiliario in lamiera di ferro piegata di 3 mm Con parti in plastica sotto i piedi per proteggere la superficie dove si trova.</i>
REF	↕↔		
 <b>SPR 01</b>	58 x 43,3 x 28 cm 22,8 x 17 x 11 in.	10,5 kg 23,1 lb.	

ENVIRONMENTAL IMPACT				FIRE RESISTANCE RESISTENCIA AL FUEGO	RÉSISTANCE AU FEU RESISTENZA AL FUOCO		
Materials may be easily disassembled to be recycled.	Materiales fácilmente segregables para su posterior reciclado.	<i>Matériaux facilement démontables pour leurs recyclages.</i>	<i>Materiali facilmente separabile per un successivo riciclaggio.</i>	UNE-EN 13501-1	A1-s1, d0		
WARRANTY	GARANTIA	GARANTIE	GARANZIA	PACKAGING	EMBALAJE	EMBALLAGE	IMBALLAGGIO
Two (2) year limited warranty. Does not cover: incorrect use, bad handling or deliberate damage.	Garantía de dos (2) años limitada. No cubre: mal uso, manipulación o daños intencionados.	<i>Garantie deux (2) ans. À l'exception: mauvaise utilisation, manipulation, dommages intentionnés.</i>	<i>Due (2) anni di garanzie limitati. Non copre: uso improprio, manipolazione o danno intenzionale.</i>	Cardboard box with plastic bag for product protection. One package.	Caja de cartón con bolsa de plástico para protección. Un paquete.	<i>Boîte en carton avec sac plastique pour la protection. Un paquet.</i>	<i>Scatola di cartone con sacchetto di plastica per protezione. Un pacco.</i>



BRAND COLORS

- |  |   |
|--|---|
|  BL · Ral 9003 |  VD · Ral 6000 |
|  CE · Ral 7033 |  PE · Ral 5020 |
|  GR · Ral 7015 |  AZ · Ral 5009 |
|  AN · Ral 7016 |  BD · Ral 3005 |
|  MA · Ral 8014 |  RJ · Ral 3020 |
|  OP · Ral 1036 |  RS · Ral 2012 |
|  VF · Ral 6020 |  AM · Ral 1007 |
|  VO · Ral 6011 |  NJ · Ral 2017 |

CUSTOMIZE OPTIONS





PERSONNALISER LES OPTIONS

OPCIONES PERSONALIZADAS

OPZIONI DI PERSONALIZZAZIONE

 RAL COLOR

LABELS

- |   |  |
|---|--|
| Thickness  3 mm    | Acoustic  Doesn't absorb sound            |
| Material  Iron     | Fire resistance  UNE-EN 13501-1 A1-s1, d0 |
| Finish  Painting   | Optimal Space  Indoor                     |
| Conductivity  100% | Cleaning  Water & Drying                  |
|   | Weight  10,5 kg / 23,1 lb.                |



# Albury

by Drop Innovation

**A honeycomb shaped modular shelving system with wall and floor support, its modular metal structure allows you to make unequal and creative combinations. Breaking the space sympathetically creating a library to your liking. It also has a more minimalist design to use horizontally and an optional magnetic mini-shelf to horizontally place objects.**

*Rayonnage en forme de nid d'abeille appuyé sur le sol, sa structure métallique modulaire permet de faire des combinaisons asymétriques et créatives. Brisez l'espace avec sympathie et organisez la bibliothèque à votre guise. Il existe également un modèle plus minimaliste à utiliser horizontalement et une mini-étagère magnétique en option pour aligner horizontalement un objet.*

Estantería en forma de panal de abeja con apoyo en el suelo, su estructura metálica modular permite hacer combinaciones desiguales y creativas. Rompe de manera simpática el espacio y ordena la biblioteca a tu gusto. También tiene un modelo para usar en horizontal más minimalista y un mini-estante magnético opcional para alinear horizontalmente algún objeto.

Mensola sagomata nido d'ape con supporto a terra, la sua struttura metallo modulare permette fare combinazioni irregolare e creativo. Rompe lo spazio e ordina la biblioteca a tuo gusto. C'e anche un modello da usare in orizzontale più minimalista e un mini scaffale magnetico opzionale per allineare orizzontalmente qualche oggetto.











# More about Albury

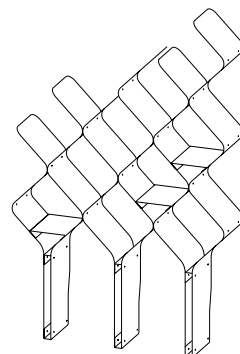

SCALE 1:20 (cm)



DESIGNER





Drop Innovation

YEAR

2016

LINE SKETCH

PRODUCT	REFERENCE	SIZE
	<b>ALB 03</b>	21 x 28 x 112 cm 8,3 x 11 x 44,1 in.
	<b>ALB 04</b>	21 x 28 x 147,4 cm 8,3 x 11 x 58 in.
	<b>ALB 05</b>	21 x 28 x 172,8 cm 8,3 x 11 x 68 in.

PRODUCT	REFERENCE	SIZE
	<b>ALB 06</b>	21 x 28 x 198,2 cm 8,3 x 11 x 78 in.
	<b>ALB 10</b> MAGNETIC SHELF	21 x 28 x 4 cm 8,3 x 11 x 1,6 in.
	<b>ALB 11</b> MAGNETIC SHELF	21 x 24 x 4 cm 8,3 x 9,4 x 1,6 in.
	<b>ALB 20</b> MAGNETIC SHELF	152 x 24 x 21 cm 59,8 x 9,4 x 8,3 in.

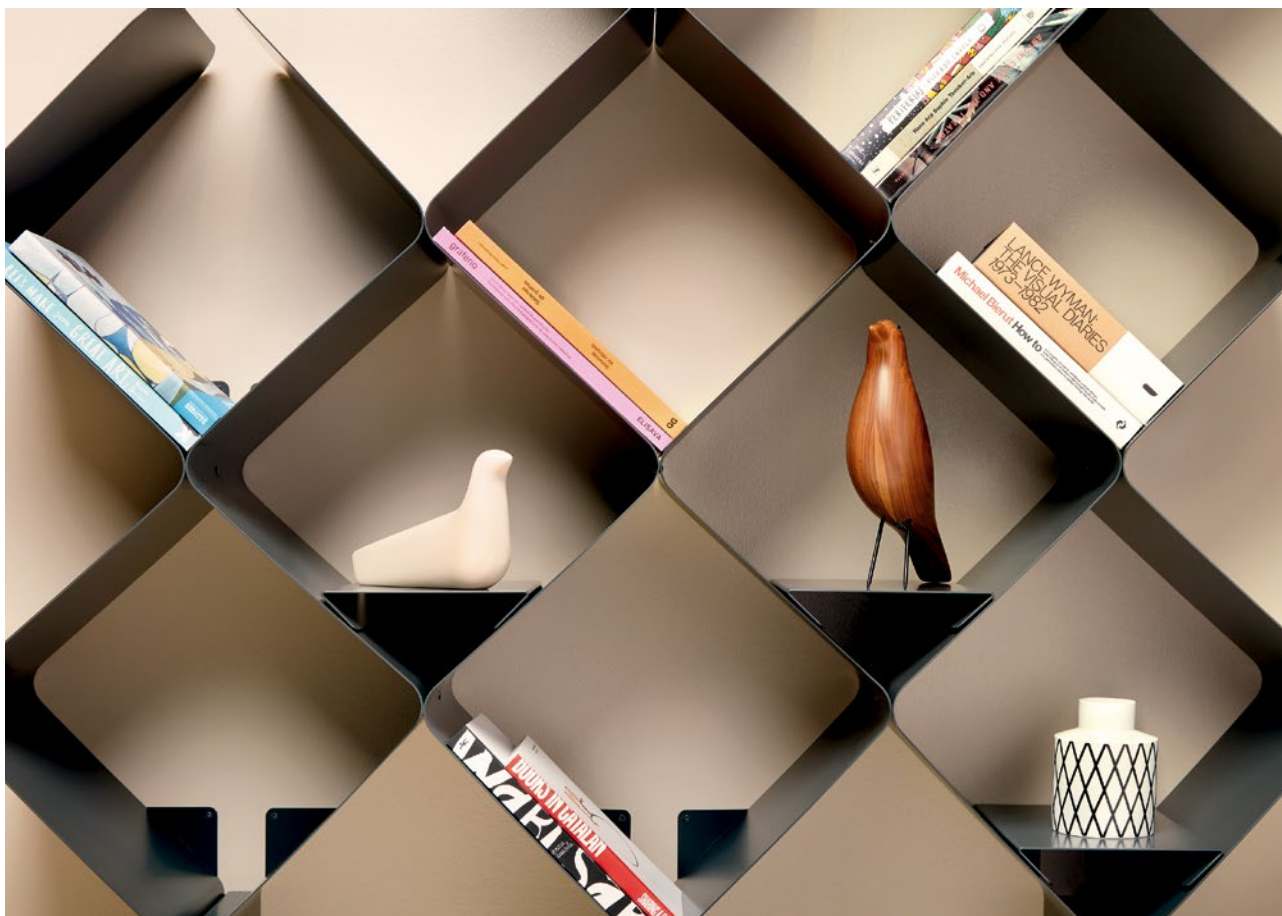

ALBURY SET WITH HORIZONTAL MAGNETIC SHELF

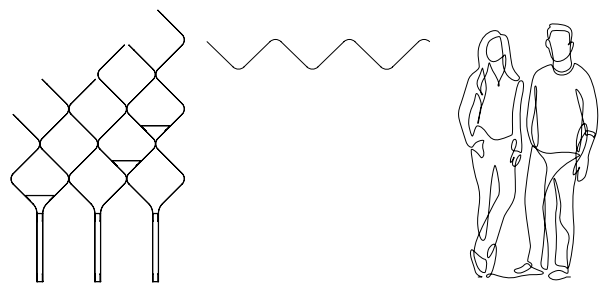

HORIZONTAL ALBURY WITH MAGNETIC SHELF – ALB 20 9003









# Albury

by Drop Innovation

← VIEW PRODUCT PAGES

294

CHARACTERISTICS	CARACTERÍSTICAS	CARACTÉRISTIQUES	CARATTERISTICHE
Shelves composed of modular structures of 2mm iron of different heights. Assembled by screws at the bottom and metal threads at the top. Supported on the ground and fixed to the wall using rawlplugs and screws. It is necessary to assemble an even number of shelves to achieve balance. Horizontal wall version attached to the wall using screws and rawlplugs.	Estantería compuesta de estructuras modulares de chapa de hierro de 2 mm y de diferente altura. Ensamblada mediante tornillos en la parte inferior y roscas metálicas en la parte superior. Apoyada al suelo y fijada a pared mediante tacos y tornillos. Es necesario ensamblar un número par de estructuras. Versión mural horizontal fijada a pared mediante tornillos.	<i>Etagère composée de structures modulaires en tôle de 2 mm d'épaisseur et de différentes hauteurs. Assemblée avec des vis en partie inférieure et des boulons métalliques en partie haute. Supportée au sol et fixée au mur à l'aide de chevilles et de vis. Il est nécessaire d'assembler un nombre pair de structures. Version murale horizontale fixée au mur à l'aide de vis.</i>	<i>Scaffalatura composta da strutture modulari in lamiera Ferro da 2 mm di diversa altezza. Assemblato da viti sul fondo e filettature metalliche su la cima. Appoggiato a terra e fissato al muro mediante tasselli e viti. Bisogna di assemblare un numero pari di strutture. Versione murale orizzontale fissate a parete mediante viti.</i>

















	REF	↕↔			REF	↕↔	
	<b>ALB 03</b>	21 x 28 x 112 cm 8,3 x 11 x 44,1 in.	7,5 kg 16,5 lb.		<b>ALB 20</b>	152 x 24 x 21 cm 59,8 x 9,4 x 8,3 in.	10,5 kg 23,1 lb.
	<b>ALB 04</b>	21 x 28 x 147,4 cm 8,3 x 11 x 58 in.	9,2 kg 20,3 lb.		<b>ALB 10</b> MAGNETIC SHELF	21 x 28 x 4 cm 8,3 x 11 x 1,6 in.	1,5 kg 3,3 lb.
	<b>ALB 05</b>	21 x 28 x 172,8 cm 8,3 x 11 x 68 in.	12,6 kg 27,8 lb.		<b>ALB 11</b> MAGNETIC SHELF	21 x 24 x 4 cm 8,3 x 9,4 x 1,6 in.	1,5 kg 3,3 lb.
	<b>ALB 06</b>	21 x 28 x 198,2 cm 8,3 x 11 x 78 in.	15 kg 33,1 lb.				

ENVIRONMENTAL IMPACT				FIRE RESISTANCE	RÉSISTANCE AU FEU
				RESISTENCIA AL FUEGO	RESISTENZA AL FUOCO
Materials may be easily disassembled to be recycled.	Materiales fácilmente segregables para su posterior reciclado.	<i>Matériaux facilement démontables pour leurs recyclages.</i>	<i>Materiali facilmente separabile per un successivo riciclaggio.</i>	UNE-EN 13501-1	A1-s1, d0

WARRANTY	GARANTIA	GARANTIE	GARANZIA	PACKAGING	EMBALAJE	EMBALLAGE	IMBALLAGGIO
Two (2) year limited warranty. Does not cover: incorrect use, bad handling or deliberate damage.	Garantía de dos (2) años limitada. No cubre: mal uso, manipulación o daños intencionados.	<i>Garantie deux (2) ans. À l'exception: mauvaise utilisation, manipulation, dommages intentionnés.</i>	<i>Due (2) anni di garanzie limitati. Non copre: uso improprio, manipolazione o danno intenzionale.</i>	Cardboard box with plastic bag for product protection. One package.	Caja de cartón con bolsa de plástico para protección. Un paquete.	<i>Boîte en carton avec sac plastique pour la protection. Un paquet.</i>	<i>Scatola di cartone con sacchetto di plastica per protezione. Un pacco.</i>











BRAND COLORS

	BL · Ral 9003		VD · Ral 6000
	CE · Ral 7033		PE · Ral 5020
	GR · Ral 7015		AZ · Ral 5009
	AN · Ral 7016		BD · Ral 3005
	MA · Ral 8014		RJ · Ral 3020
	OP · Ral 1036		RS · Ral 2012
	VF · Ral 6020		AM · Ral 1007
	VO · Ral 6011		NJ · Ral 2017

CUSTOMIZE OPTIONS      PERSONNALISER LES OPTIONS  
 OPCIONES PERSONALIZADAS      OPZIONI DI PERSONALIZZAZIONE

 RAL COLOR

LABELS

Thickness  2 mm	Acoustic  Doesn't absorb sound
Material  Iron	Fire resistance  UNE-EN 13501-1 A1-s1, d0
Finish  Painting	Optimal Space  Indoor
Conductivity  100%	Cleaning  Water & Drying
	Weight  See page 332



# Obliqua

---

by Joan Cinca

**Many times the covers of your favorite books are very beautiful, now with Obliqua you can have them permanently displayed in your library. And shelves adjustable in height and profiles available in 16 colors.**

Muchas veces las portadas de tus libros preferidos son muy bonitas, ahora con Obliqua podrás tenerlas de manera permanente exhibidas en tu biblioteca. Y Estantes graduables en altura y perfiles disponibles en 16 colores.

*Souvent, les couvertures de vos livres préférés sont très belles, désormais avec Obliqua vous pouvez les afficher en permanence dans votre bibliothèque. Et des étagères réglables en hauteur et des profils disponibles en 16 couleurs.*

**Molte volte le copertine dei tuoi libri preferiti sono molto belle, ora con Obliqua puoi averle permanentemente esposte nella tua libreria. E ripiani regolabili in altezza e profili disponibili in 16 colori.**











# More about Obliqua

DESIGNER

Joan Cinca

YEAR

2024

LINE SKETCH

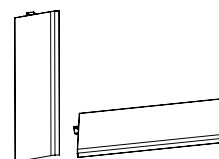

SCALE 1:20 (cm)

PRODUCT

REFERENCE

SIZE



**OBL/100/V**

100 cm  
39,4 in.



**OBL/150/V**

150 cm  
59 in.

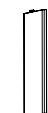

**OBL/200/V**

200 cm  
78,7 in.



**OBL/1**

33 x 4,3 cm  
13 x 1,7 in.

PRODUCT

REFERENCE

SIZE



**OBL/100/H**

100 cm  
39,4 in.



**OBL/150/H**

150 cm  
59 in.



**OBL/200/H**

200 cm  
78,7 in.



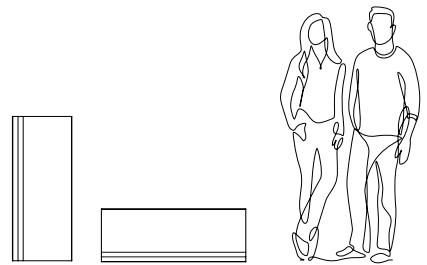









# Obliqua

by Joan Cinca

← VIEW PRODUCT PAGES

302

CHARACTERISTICS	CARACTERÍSTICAS	CARACTÉRISTIQUES	CARATTERISTICHE
Modular shelving system made of 3 mm thick lacquered aluminum profile. The slats are installed using screws on the wall vertically or horizontally as needed, achieving the desired design. In the vertical system, the lacquered metal shelves of the same color as the profile are fixed by pressure in the slot of the same profile.	Sistema de estantería modular fabricado en perfil de aluminio lacado de 3 mm de espesor. Las lamas se instalan mediante tornillería en la pared de manera vertical u horizontal según necesidad, consiguiendo el diseño deseado. En el sistema vertical las baldas metálicas lacadas del mismo color que el perfil se fijan por presión en la ranura del mismo perfil.	<i>Système d'étagères modulaires en profilé d'aluminium laqué de 3 mm d'épaisseur. Les lattes sont installées à l'aide de vis sur le mur verticalement ou horizontalement selon les besoins, obtenant ainsi le design souhaité. Dans le système vertical, les étagères en métal laqué de la même couleur que le profilé sont fixées par pression dans la fente du même profilé.</i>	<i>Sistema di scaffalature modulari realizzato con profilo in alluminio laccato di spessore 3 mm. Le lamelle vengono installate utilizzando viti sulla parete verticalmente o orizzontalmente secondo necessità, ottenendo il design desiderato. Nel sistema verticale i ripiani in metallo laccato dello stesso colore del profilo vengono fissati a pressione nell'asola del profilo stesso.</i>







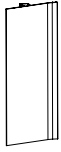









	REF	↕↔			REF	↕↔	
	<b>OBL/100/V</b>	100 x 28,5 cm 39,4 x 11,2 in.	3 kg 6,6 lb.		<b>OBL/100/H</b>	28,5 x 100 cm 11,2 x 39,4 in.	3 kg 6,6 lb.
	<b>OBL/150/V</b>	150 x 28,5 cm 59 x 11,2 in.	4,4 kg 9,7 lb.		<b>OBL/150/H</b>	28,5 x 150 cm 11,2 x 59 in.	4,4 kg 9,7 lb.
	<b>OBL/200/V</b>	200 x 28,5 cm 78,7 x 11,2 in.	6 kg 13,2 lb.		<b>OBL/200/H</b>	28,5 x 200 cm 11,2 x 78,7 in.	6 kg 13,2 lb.
	<b>OBL/1</b>	33 x 4,3 cm 13 x 1,7 in.	0,6 kg 1,3 lb.				

ENVIRONMENTAL IMPACT				FIRE RESISTANCE	RÉSISTANCE AU FEU
				RESISTENCIA AL FUEGO	RESISTENZA AL FUOCO
Materials may be easily disassembled to be recycled.	Materiales fácilmente segregables para su posterior reciclado.	<i>Matériaux facilement démontables pour leurs recyclages.</i>	<i>Materiali facilmente separabile per un successivo riciclaggio.</i>	UNE-EN 13501-1	A1-s1, d0

WARRANTY	GARANTIA	GARANTIE	GARANZIA	PACKAGING	EMBALAJE	EMBALLAGE	IMBALLAGGIO
Two (2) year limited warranty. Does not cover: incorrect use, bad handling or deliberate damage.	Garantía de dos (2) años limitada. No cubre: mal uso, manipulación o daños intencionados.	<i>Garantie deux (2) ans. À l'exception: mauvaise utilisation, manipulation, dommages intentionnés.</i>	<i>Due (2) anni di garanzie limitati. Non copre: uso improprio, manipolazione o danno intenzionale.</i>	Cardboard box with plastic bag for product protection. One package.	Caja de cartón con bolsa de plástico para protección. Un paquete.	<i>Boîte en carton avec sac plastique pour la protection. Un paquet.</i>	<i>Scatola di cartone con sacchetto di plastica per protezione. Un pacco.</i>











BRAND COLORS

 BL · Ral 9003	 VD · Ral 6000
 CE · Ral 7033	 PE · Ral 5020
 GR · Ral 7015	 AZ · Ral 5009
 AN · Ral 7016	 BD · Ral 3005
 MA · Ral 8014	 RJ · Ral 3020
 OP · Ral 1036	 RS · Ral 2012
 VF · Ral 6020	 AM · Ral 1007
 VO · Ral 6011	 NJ · Ral 2017

CUSTOMIZE OPTIONS      PERSONNALISER LES OPTIONS  
 OPCIONES PERSONALIZADAS      OPZIONI DI PERSONALIZZAZIONE

 RAL COLOR

LABELS

Thickness  3 mm	Acoustic  Doesn't absorb sound
Material  Aluminium	Fire resistance  UNE-EN 13501-1 A1-s1, d0
Finish  Lacquered	Optimal Space  Indoor
Conductivity  100%	Cleaning  Water & Drying
	Weight  See page 340



---

# Hangers

05

---



---

<b>312</b>	Bergamo
<b>320</b>	Milano
<b>328</b>	Siena
<b>336</b>	Padova
<b>344</b>	Torino
<b>352</b>	Napoli
<b>360</b>	Milard
<b>368</b>	Bologna

# Bergamo

by La Mamba Studio

**Wall mounted or in a rack with four hooks and a functional upper shelf, this coat rack adapts to your needs. A fusion of metal and beech wood that combine perfectly.**

De pie, en la pared o en rack de cuatro colgadores y una funcional repisa superior, este perchero se adapta a lo que necesites para tu espacio. Una fusión de metal y madera de haya que combina a la perfección.

*Debout, au mur ou dans un rack avec quatre patères et une étagère supérieure fonctionnelle, ce portemanteau s'adapte à tout ce dont vous avez besoin pour votre espace. Une fusion du métal et du bois de hêtre qui se combine à la perfection.*

In piedi, sul muro o dentro quattro appendiabiti e un ripiano funzionale in alto, questo appendiabiti si adatta per qualunque cosa di cui hai bisogno per il tuo spazio. Una fusione di metallo e legno di faggio che si combina perfettamente.









# More about Bergamo

DESIGNER

La Mamba Studio

YEAR

2016 / 2019

LINE SKETCH

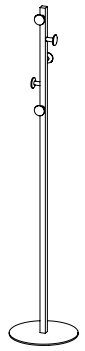

SCALE 1:40 (cm)

PRODUCT

REFERENCE

SIZE



**BRG 10**

Ø36 x 180 cm  
Ø14,2 x 70,9 in.



**BRG 01**

70 x 10 x 10 cm  
4,6 x 3,9 x 3,9 in.



**BRG M**

Ø5,5 x 5,5 cm  
Ø2,2 x 2,2 in.

Only in wood



SHELF WITH RACK – BRG 01 9003

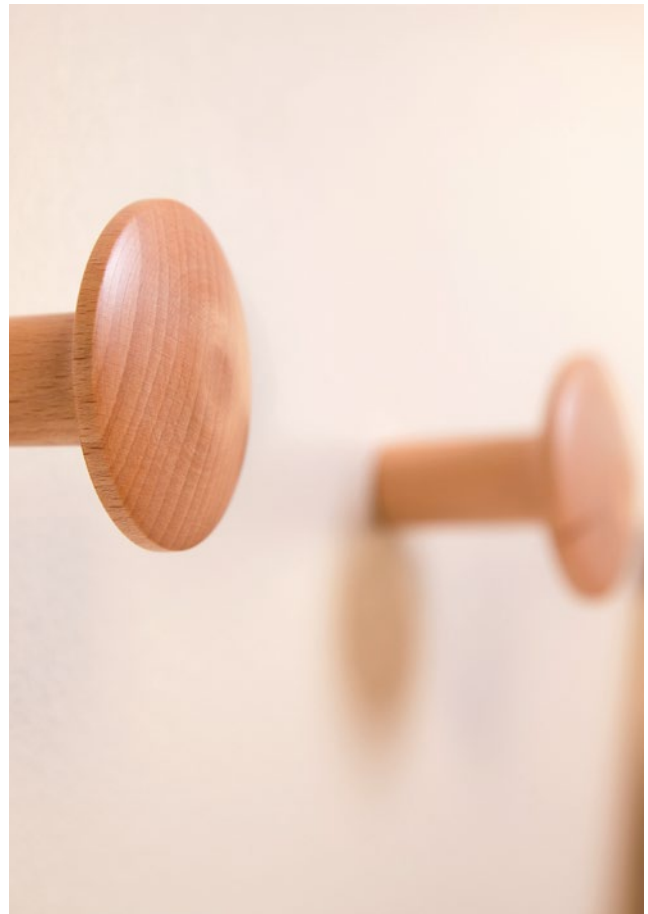

WALL MOUNTED VERSION – BRG M

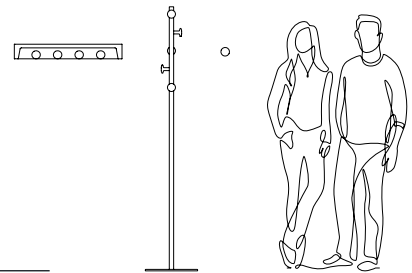

COAT RACK CLOSE UP – BRG 10 7016





# Bergamo

by La Mamba Studio

← VIEW PRODUCT PAGES

312

CHARACTERISTICS	CARACTERÍSTICAS	CARACTÉRISTIQUES	CARATTERISTICHE
Beech wood hanger, included in a sheet metal wall structure, attached using rawlplugs or as a coat stand. Wall structure made from 1.2mm sheet metal. Standing coat rack with 25mm square metal pole. Weighted base in stamped sheet metal. The post and base are unified using screws. Base supplied with rubber blocks to protect the surface where it is located.	Colgador de madera de haya torneada, situado en una estructura mural, en un perchero de pié o directo a pared mediante taco y tornillo de doble rosca. Estructura mural en chapa de hierro de 1,2 mm. Perchero de pié en tubo metálico cuadrado de 25 mm. Base en chapa de hierro estampada con peso en la parte inferior. Unión del tubo y base mediante tornillería. Base con tacos de goma para proteger la superficie donde se ubique.	<i>Porte-manteau en bois de hêtre tourné, situé dans une structure murale, sur pied ou directement au mur à l'aide d'une cheville et d'une vis à double filetage. Structure murale en tôle de 1,2 mm. Portemanteau sur pied en tube métallique carré de 25 mm. Base en tôle emboutie avec poids dans la partie inférieure. Union du tube et de la base à l'aide de vis. Base avec des gommages de caoutchouc pour protéger la surface où il se trouve.</i>	<i>Appendiabiti in legno di faggio girato, situato in una struttura murale, su un appendiabiti o diretto alla parete mediante spina e doppia vite filettata. Struttura a parete in lamiera ferro da 1,2 mm. Appendiabiti piedi in tubo quadrato di metallo di 25mm. Base in lamiera di ferro stampata con peso nella parte inferiore. Unione del tubo e della base mediante viti. Base con borchie in gomma per proteggere il superficie dove si trova.</i>

	REF	↕↔	
	<b>BRG 10</b>	Ø36 x 180 cm Ø14,2 x 70,9 in.	7,5 kg 16,5 lb.
	<b>BRG 01</b>	70 x 10 x 10 cm 4,6 x 3,9 x 3,9 in.	3,5 kg 7,7 lb.
	<b>BRG M</b>	Ø5,5 x 5,5 cm Ø2,2 x 2,2 in.  Only in wood	0,3 kg 0,7 lb.









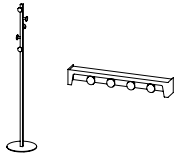







ENVIRONMENTAL IMPACT				FIRE RESISTANCE	RÉSISTANCE AU FEU
				RESISTENCIA AL FUEGO	RESISTENZA AL FUOCO
Materials may be easily disassembled to be recycled.	Materiales fácilmente segregables para su posterior reciclado.	<i>Matériaux facilement démontables pour leurs recyclages.</i>	<i>Materiali facilmente separabile per un successivo riciclaggio.</i>	UNE-EN 13501-1	D-s2, d0

WARRANTY	GARANTIA	GARANTIE	GARANZIA	PACKAGING	EMBALAJE	EMBALLAGE	IMBALLAGGIO
Two (2) year limited warranty. Does not cover: incorrect use, bad handling or deliberate damage.	Garantía de dos (2) años limitada. No cubre: mal uso, manipulación o daños intencionados.	<i>Garantie deux (2) ans. À l'exception: mauvaise utilisation, manipulation, dommages intentionnés.</i>	<i>Due (2) anni di garanzie limitati. Non copre: uso improprio, manipolazione o danno intenzionale.</i>	Cardboard box with plastic bag for product protection. Two packages.	Caja de cartón con bolsa de plástico para protección. Dos paquetes.	<i>Boîte en carton avec sac plastique pour la protection. Deux paquets.</i>	<i>Scatola di cartone con sacchetto di plastica per protezione. Dues pacchi.</i>



BRAND COLORS



 BL · Ral 9003	 VD · Ral 6000	 WOOD
 CE · Ral 7033	 PE · Ral 5020	
 GR · Ral 7015	 AZ · Ral 5009	
 AN · Ral 7016	 BD · Ral 3005	
 MA · Ral 8014	 RJ · Ral 3020	
 OP · Ral 1036	 RS · Ral 2012	
 VF · Ral 6020	 AM · Ral 1007	
 VO · Ral 6011	 NJ · Ral 2017	

CUSTOMIZE OPTIONS

PERSONNALISER LES OPTIONS

OPCIONES PERSONALIZADAS

OPZIONI DI PERSONALIZZAZIONE

 RAL COLOR

 NUMBER OF HANGERS

LABELS

Thickness  1,2 mm

Acoustic  Doesn't absorb sound

Material  Iron + Wood

Fire resistance  UNE-EN 13501-1 D-s2, d0

Finish  Painting

Optimal Space  Indoor

Conductivity  100% \*iron

Cleaning  Water & Drying

Weight  See page 162

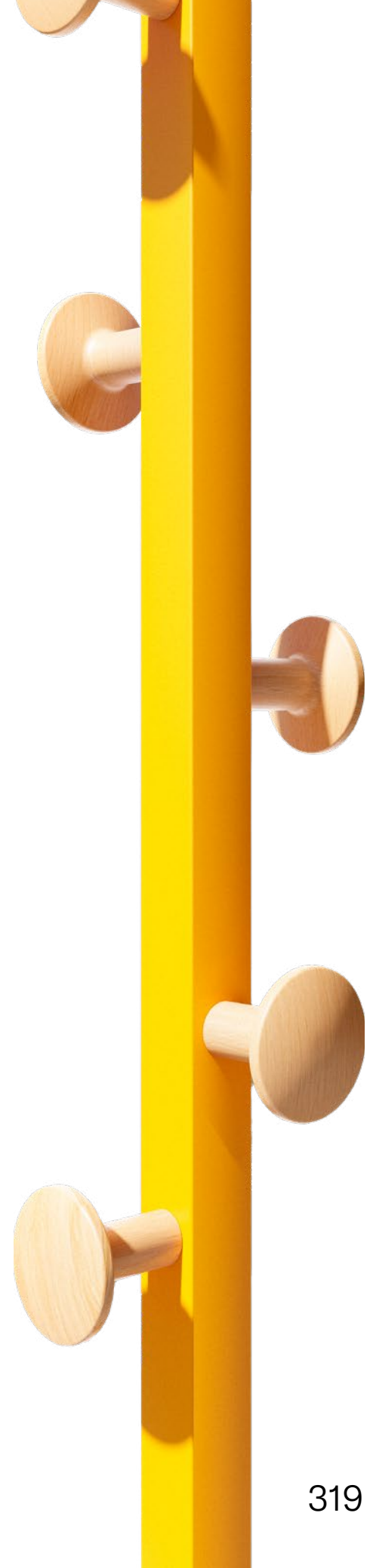

# Milano

by Roger Vancells

**Choose how to add warmth to your project with this original designer coat stand. A silhouette of beech wooden curved slats in two versions; three or six slats as well as mini metal wall hangers.**

Elige cómo añadir a tu espacio calidez con este original perchero de diseño. Una silueta de lamas de madera de haya curvadas en dos versiones; tres o seis lamas, y también una mini lama metálica ideal para pared.

*Choisissez comment ajouter de la chaleur à votre espace avec ce porte-manteau de design original. Une silhouette conçues de lattes en bois de hêtre courbées en deux versions ; trois ou six lattes, et aussi une mini patère en métal idéale pour le mur.*

**Scegli come aggiungere calore al tuo spazio con questo appendiabiti originale design. Una silhouette di doghe in legno di faggio curvato in due versioni; tre o sei doghe, e anche una mini stecca metallo ideale per parete.**









# More about Milano

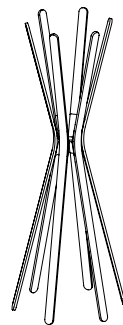

SCALE 1:40 (cm)

DESIGNER

Roger Vancells

YEAR

2015 / 2018

LINE SKETCH

PRODUCT

REFERENCE

SIZE



**MIL 03**

Ø61 x 165 cm  
Ø24 x 65 in.



**MIL 06**

Ø61 x 165 cm  
Ø24 x 65 in.



**MIL 16**

5 x 10 x 34,4 cm  
2 x 3,9 x 13,5 in.

Only available in metal



COAT RACK CLOSE UP – MIL 06 WOOD



CENTRAL UNIFIER FOR THREE SPINES CLOSE UP – MIL 03 7016  
CENTRAL UNIFIER FOR SIX SPINES CLOSE UP – MIL 06 WOOD

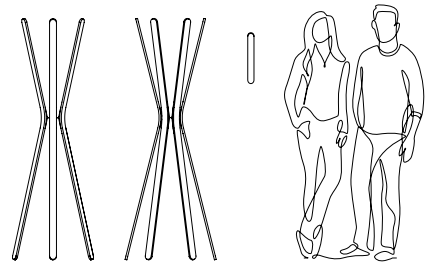

WOODEN SPINE CLOSE UP – MIL 03 WOOD



WALL MOUNTED METAL VERSION – MIL 16 5009



# Milano

by Roger Vancells

← VIEW PRODUCT PAGES

320

CHARACTERISTICS	CARACTERÍSTICAS	CARACTÉRISTIQUES	CARATTERISTICHE
Coat stand and wall rack. Available in 3 or 6, 5 cm curved beech slats, central unification made from 3mm sheet metal attached using non visible screws. Wood slats natural or lacquered. Wall version in 3 mm iron sheet metal. Fixing to the wall using a rawlplug and screw.	Perchero de pie y mural. Disponible en 3 o 6 lamas de madera de haya curvada de 5 cm, unidas a una pieza central en chapa de hierro de 3 mm mediante tornillería no visible. Lamas de madera al natural o lacadas. Versión mural en chapa de hierro de 3 mm. Fijación a pared mediante taco y tornillo.	<i>Porte-manteau sur pied et mural. Disponible en 3 ou 6 lattes de bois de hêtre courbé de 5 cm, reliées par une pièce centrale en tôle de 3 mm d'épaisseur par des vis non visibles. Lames en bois naturel ou laquées. Version murale en tôle de 3 mm d'épaisseur. Fixation au mur à l'aide de cheville et vis.</i>	<i>Appendiabiti di piedi e murale. Disponibile in 3 o 6 doghe in legno di faggio curvata di 5 cm, unito ad un pezzo centrale di lamiera di ferro da 3 mm mediante viti non a vista. Doghe in legno naturale o laccato. Versione murale in lamiera di ferro da 3 mm. Fissaggio a parete con tassello e vite.</i>

	REF	↕↔	📏
	<b>MIL 03</b>	Ø61 x 165 cm Ø24 x 65 in.	6 kg 13,2 lb.
	<b>MIL 06</b>	Ø61 x 165 cm Ø24 x 65 in.	9 kg 19,8 lb.
	<b>MIL 16</b>	5 x 10 x 34,4 cm 2 x 3,9 x 13,5 in.  Only available in metal	0,5 kg 1,1 lb.

















ENVIRONMENTAL IMPACT				FIRE RESISTANCE	RÉSISTANCE AU FEU
				RESISTENCIA AL FUEGO	RESISTENZA AL FUOCO
Materials may be easily disassembled to be recycled.	Materiales fácilmente segregables para su posterior reciclado.	<i>Matériaux facilement démontables pour leurs recyclages.</i>	<i>Materiali facilmente separabile per un successivo riciclaggio.</i>	UNE-EN 13501-1	<b>MIL 03</b> <b>MIL 06</b> <b>MIL 16</b>  D-s2, d0 D-s2, d0 A1-s1, d0

WARRANTY	GARANTIA	GARANTIE	GARANZIA	PACKAGING	EMBALAJE	EMBALLAGE	IMBALLAGGIO
Two (2) year limited warranty. Does not cover: incorrect use, bad handling or deliberate damage.	Garantía de dos (2) años limitada. No cubre: mal uso, manipulación o daños intencionados.	<i>Garantie deux (2) ans. À l'exception: mauvaise utilisation, manipulation, dommages intentionnés.</i>	<i>Due (2) anni di garanzie limitati. Non copre: uso improprio, manipolazione o danno intenzionale.</i>	Cardboard box with plastic bag for product protection. Two packages.	Caja de cartón con bolsa de plástico para protección. Dos paquetes.	<i>Boîte en carton avec sac plastique pour la protection. Deux paquets.</i>	<i>Scatola di cartone con sacchetto di plastica per protezione. Dues pacchi.</i>





BRAND COLORS

 BL · Ral 9003	 VD · Ral 6000	 WOOD
 CE · Ral 7033	 PE · Ral 5020	
 GR · Ral 7015	 AZ · Ral 5009	
 AN · Ral 7016	 BD · Ral 3005	
 MA · Ral 8014	 RJ · Ral 3020	
 OP · Ral 1036	 RS · Ral 2012	
 VF · Ral 6020	 AM · Ral 1007	
 VO · Ral 6011	 NJ · Ral 2017	

CUSTOMIZE OPTIONS









PERSONNALISER LES OPTIONS

OPCIONES PERSONALIZADAS

OPZIONI DI PERSONALIZZAZIONE



LABELS

Thickness  3 mm	Acoustic  -
Material  Wood + Iron	Fire resistance  UNE-EN 13501-1 D-s2, d0 / UNE-EN 13501-1 A1-s1, d0
Finish  Lacquered	Optimal Space  Indoor
Conductivity  No	Cleaning  Water & Drying
	Weight  See page 170

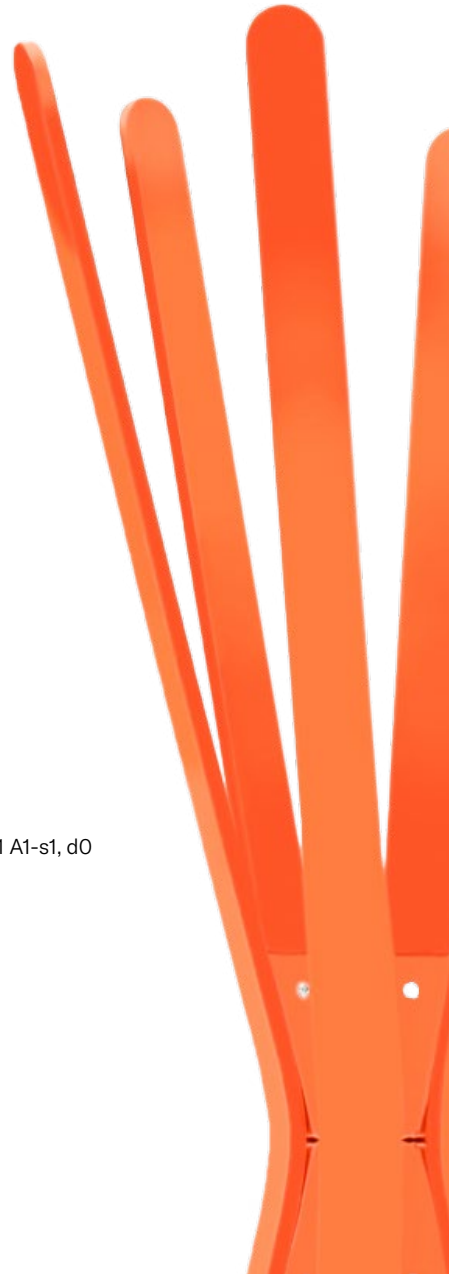

# Siena

by Nahtrang

**What if, besides a coat stand it's a signpost. Made from wood with four metal hooks pointing to four different places: The Moon, the Sun, Jupiter and Mercury are the preferred destinations of the standard model, but you can customise them with whatever you want. It is ideal in any environment.**

*Que se passe-t-il si en plus d'une patère, c'est un indicateur ? En bois avec quatre patères métalliques pointant vers quatre endroits différents : la Lune, le Soleil, Jupiter et Mercure sont les destinations préférées du modèle standard, mais vous pouvez les personnaliser comme vous le souhaitez. Il est idéal dans les environnements de confort.*

¿Y si además de colgador es un indicador? En madera con cuatro perchas metálicas apuntando a cuatro sitios diferentes: La Luna, el Sol, Júpiter y Mercurio son los destinos preferidos del modelo estándar, pero puedes personalizarlos con lo que quieras. Es ideal en ambientes confort.

**Que se passe-t-il si en plus d'une patère, c'est un indicateur ? En bois avec quatre patères métalliques pointant vers quatre endroits différents : la Lune, le Soleil, Jupiter et Mercure sont les destinations préférées du modèle standard, mais vous pouvez les personnaliser comme vous le souhaitez. Il est idéal dans les environnements de confort.**







◀ NEW YORK CITY

6.165 km

◀ TOKIO

8.711 km

◀ THE MOON

384.000 Km

◀ MERCURY

57.909.176 Km



# More about Siena

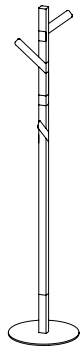

SCALE 1:40 (cm)

DESIGNER

Nahtrang

YEAR

2015

LINE SKETCH

PRODUCT

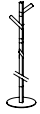

REFERENCE

**SIE 01**

SIZE

Ø36 x 180 cm  
Ø14,2 x 70,9 in.

STANDARD TEXT

THE MOON  
THE SUN  
MERCURY  
JUPITER



COAT RACK WITH STANDARD TEXT – SIE 01/1007

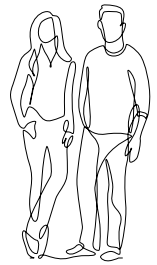

COAT RACK WITH PERSONALISED TEXT – SIE 01 7016

# Siena

by Nahtrang

← VIEW PRODUCT PAGES

328

CHARACTERISTICS	CARACTERÍSTICAS	CARACTÉRISTIQUES	CARATTERISTICHE
Coatstand made up of of a 40mm beechwood mast, with 4 hangers in 3mm folded sheet metal. Weighted base in stamped sheet metal. Unified post and base using screws. Base includes rubber blocks to protect the surface where it is located.	Perchero de pié compuesto por un mástil de madera de haya de 40 mm, con 4 colgadores en chapa de hierro doblada de 3 mm. Base en chapa de hierro estampada con peso en la parte inferior. Unión del tubo y base mediante tornillería. Base con tacos de goma para proteger la superficie donde se ubique.	Porte-manteau sur pied composé d'un mât en hêtre de 40 mm et de 4 patères en tôle pliée de 3 mm d'épaisseur. Base en tôle emboutie avec poids dans la partie inférieure. Union du tube et de la base à l'aide de vis. Base avec des gommés de caoutchouc pour protéger la surface où il se trouve.	Appendiabiti di piedi composto da un albero di faggio da 40 mm, con 4 appendini in lamiera piegata da 3mm. Base in lamiera di ferro stampata con peso nella parte inferiore. Unione del tubo e della base mediante viti. Base con borchie in gomma per proteggere il superficie dove si trova.

REF	↕↔	📏
 <b>SIE 01</b>	Ø36 x 180 cm Ø14,2 x 70,9 in.	7 kg 15,4 lb.
STANDARD TEXT THE MOON THE SUN MERCURY JUPITER		







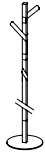









ENVIRONMENTAL IMPACT				FIRE RESISTANCE	RÉSISTANCE AU FEU
				RESISTENCIA AL FUEGO	RESISTENZA AL FUOCO
Materials may be easily disassembled to be recycled.	Materiales fácilmente segregables para su posterior reciclado.	<i>Matériaux facilement démontables pour leurs recyclages.</i>	<i>Materiali facilmente separabile per un successivo riciclaggio.</i>	UNE-EN 13501-1	D-s2, d0

WARRANTY	GARANTIA	GARANTIE	GARANZIA	PACKAGING	EMBALAJE	EMBALLAGE	IMBALLAGGIO
Two (2) year limited warranty. Does not cover: incorrect use, bad handling or deliberate damage.	Garantía de dos (2) años limitada. No cubre: mal uso, manipulación o daños intencionados.	<i>Garantie deux (2) ans. À l'exception: mauvaise utilisation, manipulation, dommages intentionnés.</i>	<i>Due (2) anni di garanzie limitati. Non copre: uso improprio, manipolazione o danno intenzionale.</i>	Cardboard box with plastic bag for product protection. Two packages.	Caja de cartón con bolsa de plástico para protección. Dos paquetes.	<i>Boîte en carton avec sac plastique pour la protection. Deux paquets.</i>	Scatola di cartone con sacchetto di plastica per protezione. Dues pacchi.





BRAND COLORS

	BL · Ral 9003		VD · Ral 6000		Wood
	CE · Ral 7033		PE · Ral 5020		
	GR · Ral 7015		AZ · Ral 5009		
	AN · Ral 7016		BD · Ral 3005		
	MA · Ral 8014		RJ · Ral 3020		
	OP · Ral 1036		RS · Ral 2012		
	VF · Ral 6020		AM · Ral 1007		
	VO · Ral 6011		NJ · Ral 2017		

Colores solo para las perchas.

Colors only for the hangers.

Couleurs uniquement pour les cintres.

Colori solo per le grucce.

CUSTOMIZE OPTIONS

OPCIONES PERSONALIZADAS









PERSONNALISER LES OPTIONS

OPZIONI DI PERSONALIZZAZIONE

 RAL COLOR

 TEXT

LABELS

Thickness		40 mm	Acoustic		-
Material		Beechwood + Iron	Fire resistance		UNE-EN 13501-1 D-s2, d0
Finish		Painting	Optimal Space		Indoor
Conductivity		100% *iron	Cleaning		Water & Drying
			Weight		7 kg / 15,4 lb. unit



# Padova

---

by Roger Vancells

**As Rams said, less is more, this coat stand has been reduced to the minimum expression. With a simple but daring design it has been fused with five hooks injected in colourful plastic on a white lacquered metal base. Now yes, less is more.**

Cómo decía Rams, menos es más, este perchero se ha reducido todo a la mínima expresión. Con un diseño sencillo pero atrevido se ha fusionado cinco perchas inyectadas en plástico colorido sobre una base metálica lacada en blanco. Ahora sí, menos es más.

*Comme le disait Rams, moins c'est plus, ce porte-manteau a été réduit au minimum. Avec un design simple mais audacieux, cinq patères en plastique injecté de couleur fusionnent avec une base en métal laqué blanche. Maintenant oui, moins c'est plus.*

**Come ha detto Rams, meno è di più, questo appendiabiti è stato tutto ridotto a espressione minima. Insieme a un design semplice ma l'audacia si è fusa cinque ganci iniettati in plastica colorata su una base di metallo laccato in bianco. Ora sì, meno è di più.**









# More about Padova

DESIGNER

Roger Vancells

YEAR

2018

LINE SKETCH

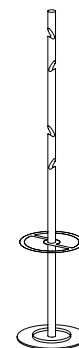

SCALE 1:40 (cm)

PRODUCT

REFERENCE

SIZE



**PDV 01**

Ø36 x 180 cm  
Ø14,2 x 70,9 in.



**PDV 10**

Ø36 x 180 cm  
Ø14,2 x 70,9 in.



**PDV P**

Ø36 x 50 cm  
Ø14,2 x 19,7 in.



HANGER CLOSE UP -PDV 01 2017 + 7016

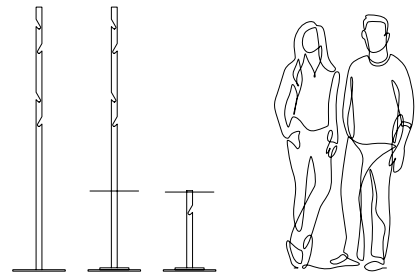

UMBRELLA STAND AND COAT STAND WITH INTEGRATED UMBRELLA HOLDER — PDV P 9003 + PDV 10 9003



COAT STAND CLOSE UP — PDV 01 9003 + PDV 01 7016



# Padova

by Roger Vancells

← VIEW PRODUCT PAGES

336

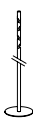
CHARACTERISTICS	CARACTERÍSTICAS	CARACTÉRISTIQUES	CARATTERISTICHE
Coat and umbrella stand manufactured with Ø40mm metal tube. Injected plastic hangers inserted into post. Weighted base in stamped sheet metal. Post and base unified using screws includes rubber blocks to protect the surface where it is located.	Perchero de pié y paraguero fabricados en tubo metálico. Colgadores inyectados en plástico encajados en el tubo. Base en chapa de hierro estampada con peso en la parte inferior. Unión del tubo y base mediante tornillería. Base con tacos de goma para proteger la superficie donde se ubique.	<i>Porte-manteau et porte-parapluie fabriqué en tube métallique de Ø40 mm. Patères en plastique injectés intégrés dans le tube. Base en tôle emboutie avec un poids dans la partie inférieure. Union du tube et de la base à l'aide de vis. Base avec des gommés de caoutchouc pour protéger la surface où il se trouve.</i>	<i>Appendiabiti di piedi e portaombrelli fabbricato in tubo metallico. Appendini in plastica iniettata incorporati nel tubo. Base in lamiera stampata con peso nella parte inferiore. Unione del tubo e della base mediante viti. Base con borchie in gomma per proteggere il superficie dove si trova.</i>

	REF	↕↔	📏
	<b>PDV 01</b>	Ø36 x 180 cm Ø14,2 x 70,9 in.	8 kg 17,6 lb.
	<b>PDV 10</b>	Ø36 x 180 cm Ø14,2 x 70,9 in.	10 kg 22 lb.
	<b>PDV P</b>	Ø36 x 50 cm Ø14,2 x 19,7 in.	5 kg 11 lb.









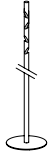











ENVIRONMENTAL IMPACT				FIRE RESISTANCE	RÉSISTANCE AU FEU
				RESISTENCIA AL FUEGO	RESISTENZA AL FUOCO
Materials may be easily disassembled to be recycled.	Materiales fácilmente segregables para su posterior reciclado.	<i>Matériaux facilement démontables pour leurs recyclages.</i>	<i>Materiali facilmente separabile per un successivo riciclaggio.</i>	UNE-EN 13501-1	B-s1, d1

WARRANTY	GARANTIA	GARANTIE	GARANZIA	PACKAGING	EMBALAJE	EMBALLAGE	IMBALLAGGIO
Two (2) year limited warranty. Does not cover: incorrect use, bad handling or deliberate damage.	Garantía de dos (2) años limitada. No cubre: mal uso, manipulación o daños intencionados.	<i>Garantie deux (2) ans. À l'exception: mauvaise utilisation, manipulation, dommages intentionnés.</i>	<i>Due (2) anni di garanzie limitati. Non copre: uso improprio, manipolazione o danno intenzionale.</i>	Cardboard box with plastic bag for product protection. Two packages.	Caja de cartón con bolsa de plástico para protección. Dos paquetes.	<i>Boîte en carton avec sac plastique pour la protection. Deux paquets.</i>	<i>Scatola di cartone con sacchetto di plastica per protezione. Dues pacchi.</i>



BRAND COLORS



 BL · Ral 9003	 VD · Ral 6000	 BL · Ral 9003
 CE · Ral 7033	 PE · Ral 5020	 GR · Ral 7015
 GR · Ral 7015	 AZ · Ral 5009	 AN · Ral 7016
 AN · Ral 7016	 BD · Ral 3005	 NJ · Ral 2004
 MA · Ral 8014	 RJ · Ral 3020	
 OP · Ral 1036	 RS · Ral 2012	
 VF · Ral 6020	 AM · Ral 1007	
 VO · Ral 6011	 NJ · Ral 2017	

CUSTOMIZE OPTIONS

PERSONNALISER LES OPTIONS









OPCIONES PERSONALIZADAS

OPZIONI DI PERSONALIZZAZIONE

 RAL COLOR

 NUMBER OF HANGERS

LABELS

Thickness  40 mm	Acoustic  -
Material  Iron + Plastic	Fire resistance  UNE-EN 13501-1 B-s1, d1
Finish  Painting	Optimal Space  Indoor
Conductivity  100% iron	Cleaning  Water & Drying
	Weight  See page 186



# Torino

---

by Eduard Juanola

**A coat rack designed for demanding work spaces thanks to six retractable hooks with great resistance. A white metal post and base, combined with hooks that are available in four standard colours. Although, if you want them to match your corporate colour, we can also customise them.**

*Un porte-manteau conçu pour les espaces de travail exigeants grâce à six patères rétractables d'une grande résistance. Avec une structure et une base en métal blanc, associées à des patères disponibles en quatre couleurs standard. Toutefois, si vous souhaitez qu'ils correspondent à la couleur corporative de votre entreprise, nous pouvons également les personnaliser.*

Un perchero pensado para espacios de trabajo exigentes gracias a seis perchas retráctiles de gran resistencia. Con una estructura y base metálica blanca, combinadas con perchas que están disponibles en cuatro colores estándar. Aunque, si quieres que hagan juego con tu color corporativo, también podemos personalizarlas.

**Un pensiero appendiabiti per gli spazi di lavoro esigenti grazie a sei appendini retrattili di grande resistenza. Con una struttura e base in metallo bianco, combinato con appendini che sono disponibili in quattro colori standard. Anche se, vuoi abbinare il tuo colore anche aziendale possiamo personalizzarli.**









# More about Torino

DESIGNER

Eduard Juanola

YEAR

2015

LINE SKETCH

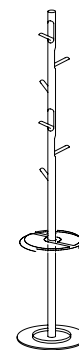

SCALE 1:40 (cm)

PRODUCT

REFERENCE

SIZE



TRN 05

Ø36 x 180 cm  
Ø14,2 x 70,9 in.



TRN 15

Ø36 x 180 cm  
Ø14,2 x 70,9 in.



TRN P

Ø36 x 50 cm  
Ø14,2 x 19,7 in.



HANGER CLOSE UP – TRN 05 9006/9003

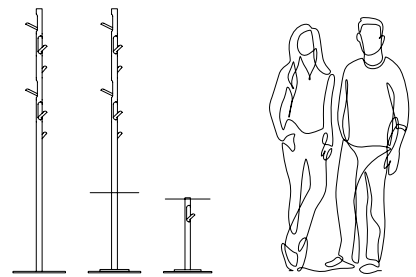

UMBRELLA STAND – TRN P

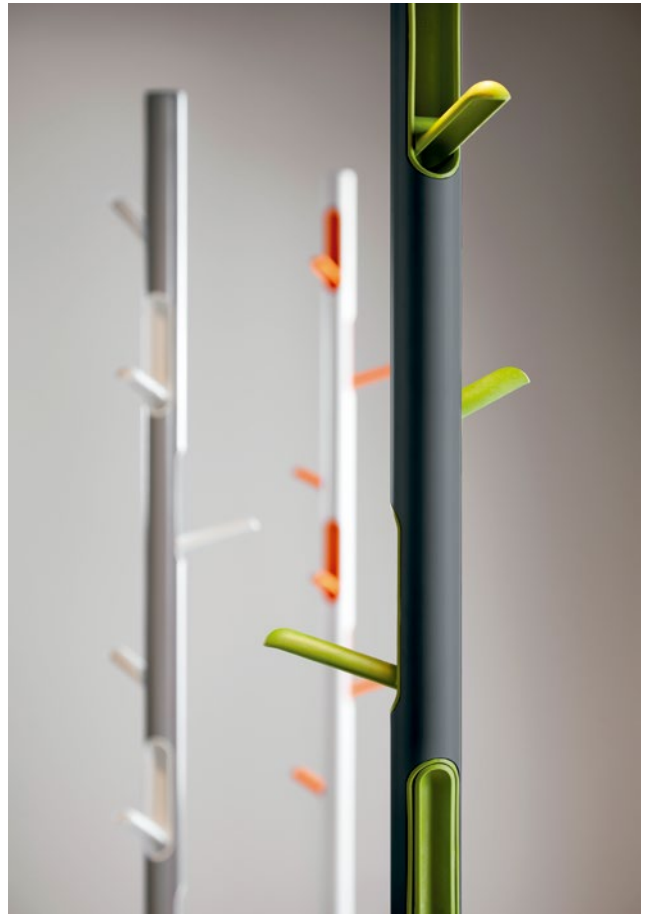

COAT STAND





# Torino

by Eduard Juanola

← VIEW PRODUCT PAGES

344

CHARACTERISTICS	CARACTERÍSTICAS	CARACTÉRISTIQUES	CARATTERISTICHE
Coat and umbrella stand made using a Ø40 mm metal tube. Hinged hangers injected in plastic embedded in the post. Weighted base in stamped sheet metal. Post and base unified using screws. Base supplied with rubber blocks to protect the surface where it is located.	Percheros de pié y paragüero fabricados en tubo metálico de Ø40 mm. Colgadores batientes inyectados en plástico encajados en el tubo. Base en chapa de hierro estampada con peso en la parte inferior. Unión del tubo y base mediante tornillería. Base con tacos de goma para proteger la superficie donde se ubique.	<i>Porte-manteau et porte-parapluie en tube métallique de Ø40 mm. Patères articulées en plastique injectés et encastrées dans le tube. Base en tôle emboutie avec poids dans la partie inférieure. Union du tube et de la base à l'aide de vis. Base avec des gommés de caoutchouc pour protéger la surface où il se trouve.</i>	<i>Appendiabiti di piedi e portaombrelli in tubo metallico di Ø40mm. Appendini oscillazione iniettato in plastica incorporato nel tubo. Base in lamiera ferro stampato con peso nella parte inferiore. Unione del tubo e della base mediante viti. Base con borchie in gomma per proteggere il superficie dove si trova.</i>

	REF	↕↔	
	<b>TRN 05</b>	Ø36 x 180 cm Ø14,2 x 70,9 in.	8 kg 17,6 lb.
	<b>TRN 15</b>	Ø36 x 180 cm Ø14,2 x 70,9 in.	10 kg 22 lb.
	<b>TRN P</b>	Ø36 x 50 cm Ø14,2 x 19,7 in.	5 kg 11 lb.









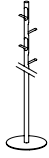











ENVIRONMENTAL IMPACT				FIRE RESISTANCE	RÉSISTANCE AU FEU
				RESISTENCIA AL FUEGO	RESISTENZA AL FUOCO
Materials may be easily disassembled to be recycled.	Materiales fácilmente segregables para su posterior reciclado.	<i>Matériaux facilement démontables pour leurs recyclages.</i>	<i>Materiali facilmente separabile per un successivo riciclaggio.</i>	UNE-EN 13501-1	B-s1, d1

WARRANTY	GARANTIA	GARANTIE	GARANZIA	PACKAGING	EMBALAJE	EMBALLAGE	IMBALLAGGIO
Two (2) year limited warranty. Does not cover: incorrect use, bad handling or deliberate damage.	Garantía de dos (2) años limitada. No cubre: mal uso, manipulación o daños intencionados.	<i>Garantie deux (2) ans. À l'exception: mauvaise utilisation, manipulation, dommages intentionnés.</i>	<i>Due (2) anni di garanzie limitati. Non copre: uso improprio, manipolazione o danno intenzionale.</i>	Cardboard box with plastic bag for product protection. Two packages.	Caja de cartón con bolsa de plástico para protección. Dos paquetes.	<i>Boîte en carton avec sac plastique pour la protection. Deux paquets.</i>	<i>Scatola di cartone con sacchetto di plastica per protezione. Dues pacchi.</i>



BRAND COLORS





 BL · Ral 9003	 VD · Ral 6000	 BL · Ral 9003
 CE · Ral 7033	 PE · Ral 5020	 NR · Ral 9011
 GR · Ral 7015	 AZ · Ral 5009	 NJ · Ral 2004
 AN · Ral 7016	 BD · Ral 3005	 VE · Ral 6018
 MA · Ral 8014	 RJ · Ral 3020	
 OP · Ral 1036	 RS · Ral 2012	
 VF · Ral 6020	 AM · Ral 1007	
 VO · Ral 6011	 NJ · Ral 2017	

CUSTOMIZE OPTIONS









PERSONNALISER LES OPTIONS

OPCIONES PERSONALIZADAS

OPZIONI DI PERSONALIZZAZIONE

-  RAL COLOR
-  NUMBER OF HANGERS

LABELS

Thickness  40 mm	Acoustic  -
Material  Iron + Plastic	Fire resistance  UNE-EN 13501-1 B-s1, d1
Finish  Painting	Optimal Space  Indoor
Conductivity  100% iron	Cleaning  Water & Drying
	Weight  See page 194



# Napoli

by Eduard Juanola

**It's almost a flying coat stand. With its six hangers in the form of two propellers, made of injected plastic on a metal base, it will give a modern and innovative look to any environment, whether at the office or at home. Also available with a matching umbrella stand.**

*Donner des ailes à votre porte-manteau. Avec ses six patères en forme d'hélices, en plastique injecté sur un pied métallique, il donnera un look moderne et innovant à votre espace, que ce soit dans les espaces de travail ou de confort. Il existe également un porte-parapluie assorti.*

Casi el perchero volador. Con sus seis perchas en forma de dos hélices, fabricadas en plástico inyectado sobre un pie metálico, le dará un aire moderno e innovador a tu espacio, ya sea en espacios de trabajo o confort. También dispone de un paragüero a juego.

Quasi l'appendiabiti volante. Con i suoi sei appendini sotto forma di due eliche, fatto di plastica inserito su un piede metallico, ti darà un'aria moderno e innovativo al tuo spazio, sia in spazi di lavoro o di confort. Ha anche di un portaombrelli coordinato.









# More about Napoli

DESIGNER

Eduard Juanola

YEAR

2019

LINE SKETCH

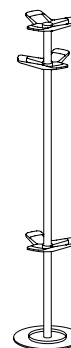

SCALE 1:40 (cm)

PRODUCT

REFERENCE

SIZE



**NAP 01**

Ø36 x 180 cm  
Ø14,2 x 70,9 in.

**NAP 10**

Ø36 x 180 cm  
Ø14,2 x 70,9 in.

**NAP P**

Ø36 x 50 cm  
Ø14,2 x 19,7 in.



BOTTOM HANGER DETAIL – NAP 02 9003

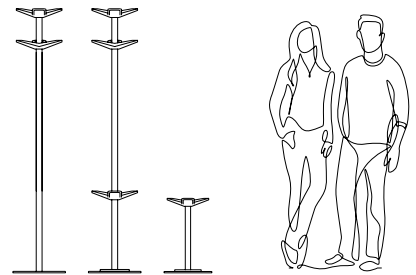

HOOK BETWEEN HANGERS — NAP 02 2004



TOP AND BOTTOM HANGER SYSTEM — NAP 02 + 7016



# Napoli

by Eduard Juanola

← VIEW PRODUCT PAGES

352

CHARACTERISTICS	CARACTERÍSTICAS	CARACTÉRISTIQUES	CARATTERISTICHE
Coat and umbrella stand manufactured in Ø40mm sheet metal tubing. Injected plastic hangers. Weighted base in stamped sheet metal. Post and base unified using screws. Base includes rubber blocks to protect the surface where it is located.	Perchero de pié y paraguero fabricados en tubo metálico de Ø40 mm. Colgadores de plástico inyectado. Base en chapa de hierro estampada con peso en la parte inferior. Unión del tubo y base mediante tornillería. Base con tacos de goma para proteger la superficie donde se ubique.	<i>Porte-manteau et porte-parapluie fabriqués en tube métallique de Ø40 mm. Patères en plastique injectés. Base en tôle emboutie avec poids dans la partie inférieure. Union du tube et de la base à l'aide de vis. Base avec des gommages de caoutchouc pour protéger la surface où il se trouve.</i>	<i>Appendiabiti di piedi e portaombrelli fabbricato in tubo metallico di Ø40mm. Appendini in plastica iniettato. Base in lamiera ferro stampato con peso nella parte inferiore. . Unione del tubo e della base mediante viti. Base con borchie in gomma per proteggere il superficie dove si trova.</i>

	REF	↕↔	📏
	<b>NAP 01</b>	Ø36 x 180 cm Ø14,2 x 70,9 in.	8 kg 17,6 lb.
	<b>NAP 10</b>	Ø36 x 180 cm Ø14,2 x 70,9 in.	9 kg 19,8 lb.
	<b>NAP P</b>	Ø36 x 50 cm Ø14,2 x 19,7 in.	4 kg 8,8 lb.



















ENVIRONMENTAL IMPACT				FIRE RESISTANCE	RÉSISTANCE AU FEU
				RESISTENCIA AL FUEGO	RESISTENZA AL FUOCO
Materials may be easily disassembled to be recycled.	Materiales fácilmente segregables para su posterior reciclado.	<i>Matériaux facilement démontables pour leurs recyclages.</i>	<i>Materiali facilmente separabile per un successivo riciclaggio.</i>	UNE-EN 13501-1	B-s1, d1

WARRANTY	GARANTIA	GARANTIE	GARANZIA	PACKAGING	EMBALAJE	EMBALLAGE	IMBALLAGGIO
Two (2) year limited warranty. Does not cover: incorrect use, bad handling or deliberate damage.	Garantía de dos (2) años limitada. No cubre: mal uso, manipulación o daños intencionados.	<i>Garantie deux (2) ans. À l'exception: mauvaise utilisation, manipulation, dommages intentionnés.</i>	<i>Due (2) anni di garanzie limitati. Non copre: uso improprio, manipolazione o danno intenzionale.</i>	Cardboard box with plastic bag for product protection. Two packages.	Caja de cartón con bolsa de plástico para protección. Dos paquetes.	<i>Boîte en carton avec sac plastique pour la protection. Deux paquets.</i>	<i>Scatola di cartone con sacchetto di plastica per protezione. Dues pacchi.</i>



BRAND COLORS



 BL · Ral 9003	 VD · Ral 6000	 BL · Ral 9003
 CE · Ral 7033	 PE · Ral 5020	 AN · Ral 7016
 GR · Ral 7015	 AZ · Ral 5009	 NJ · Ral 2004
 AN · Ral 7016	 BD · Ral 3005	
 MA · Ral 8014	 RJ · Ral 3020	
 OP · Ral 1036	 RS · Ral 2012	
 VF · Ral 6020	 AM · Ral 1007	
 VO · Ral 6011	 NJ · Ral 2017	

CUSTOMIZE OPTIONS









OPCIONES PERSONALIZADAS

PERSONNALISER LES OPTIONS

OPZIONI DI PERSONALIZZAZIONE



LABELS

Thickness  40 mm	Acoustic  -
Material  Iron + Plastic	Fire resistance  UNE-EN 13501-1 B-s1, d1
Finish  Painting	Optimal Space  Indoor
Conductivity  100% iron	Cleaning  Water & Drying
	Weight  See page 202



# Milard



by Lagranja Design

**Avant-garde and nostalgic design dedicated to two greats of Catalan design. A coat rack for offices or contract spaces that is also perfect for your home. Varnished beech or walnut wood shaft, wall-mounted or on a self-supporting base and injected plastic hangers aligned according to the desired colour combination.**

*Un design avant-gardiste et nostalgique dédié à deux grands noms du design catalan. Un porte-manteau pour les bureaux et les espaces contractuels également parfait pour votre maison. Fût en bois de hêtre ou de noyer verni, fixé au mur ou sur une base autoportante. Les cintres sont fabriqués en plastique moulé par injection et sont alignés selon la combinaison de couleurs souhaitée.*

Diseño vanguardista y nostálgico dedicado a dos grandes del diseño Catalán. Un perchero para oficinas o espacios contract que queda perfecto también en tu hogar. Estructura de madera de haya barnizada o nogal, mural o sobre base auto portante y perchas de plástico inyectado alineadas según combinación de color deseada.

Design avanguardista e nostalgico dedicato a due grandi del design catalano. Un appendiabiti per uffici o spazi contract che è anche perfetto per la tua casa. Stelo in legno di faggio o noce, verniciato, montato su una parete o su una base autoportante e appendini in plastica iniettata allineati secondo la combinazione di colori desiderata.









# More about Milard

DESIGNER

Lagranja Design

YEAR

2022

LINE SKETCH

PRODUCT

REFERENCE

SIZE



**MLR 03**

44 x 7 x 15 cm  
17,3 x 2,8 x 5,9 in.

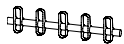

**MLR 05**

68 x 7 x 15 cm  
26,8 x 2,8 x 5,9 in.

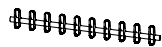

**MLR 10**

128 x 7 x 15 cm  
50,4 x 2,8 x 5,9 in.

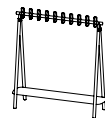

**MLR 20**

135 x 41 x 145 cm  
53,1 x 16,1 x 57,1 in.



**MLR 30**

135 x 41 x 137 cm  
53,1 x 16,1 x 53,9 in.

10 Hangers



TWO WAYS OF HANGING



PLASTIC COAT HANGERS IN THREE DIFFERENT COLOURS

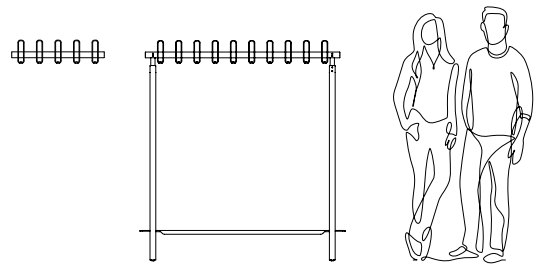

GREY PAINTED ALUMINIUM BASE



TWO WOOD TYPES - BEECH & WALNUT WOOD



# Milard

by Lagranja Design

← VIEW PRODUCT PAGES

360

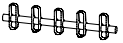
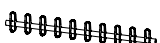
CHARACTERISTICS	CARACTERÍSTICAS	CARACTÉRISTIQUES	CARATTERISTICHE
Beech wood and walnut coat rack with 3, 5 and 10 hangers in polyamide injected with 15% glass fibre and standing rack with grey lacquered aluminium base. Available in 3 colours: blue, grey and red or combinations. Wall installation with fastening system. Fitting materials included.	Perchero mural de madera de haya y nogal compuesto por 3, 5 y 10 perchas de poliamida inyectado con un 15% de fibra de vidrio y burro con base en aluminio lacado gris. Disponible en 3 colores; azul, gris y rojo o combinaciones. Instalación a pared mediante sistema de fijación. Incluye herrajes.	Porte-manteau mural en hêtre et noyer composé de 3, 5 et 10 patères en polyamide injecté avec 15% de fibre de verre et rack debout avec base en aluminium laqué gris. Disponible en 3 couleurs : bleu, gris et rouge ou combinaisons. Installation murale au moyen d'un système de fixation. Matériel inclus pour le montage.	Appendiabiti in legno di faggio e noce con 3, 5 e 10 appendini in poliammide iniettato al 15% di fibra di vetro e appendiabiti con base in alluminio laccato grigio. Disponibile in 3 colori; blu, grigio e rosso o combinazioni. Installazione a parete mediante sistema di fissaggio. Include la ferramenta per il montaggio.

REF	↕↔	📏	
 MLR 03	44 x 7 x 15 cm 17,3 x 2,8 x 5,9 in.	0,3 kg 0,7 lb.	10 Hangers
 MLR 05	68 x 7 x 15 cm 26,8 x 2,8 x 5,9 in.	0,6 kg 1,3 lb.	
 MLR 10	128 x 7 x 15 cm 50,4 x 2,8 x 5,9 in.	0,8 kg 1.8 lb.	
 MLR 20	135 x 41 x 145 cm 53,1 x 16,1 x 57,1 in.	11 kg 24,3 lb.	
 MLR 30	135 x 41 x 137 cm 53,1 x 16,1 x 53,9 in.	10,7 kg 23,6 lb.	

ENVIRONMENTAL IMPACT				FIRE RESISTANCE	RÉSISTANCE AU FEU
				RESISTENCIA AL FUEGO	RESISTENZA AL FUOCO
Materials may be easily disassembled to be recycled.	Materiales fácilmente segregables para su posterior reciclado.	Matériaux facilement démontables pour leurs recyclages.	Materiali facilmente separabile per un successivo riciclaggio.	UNE-EN 13501-1	D-s2, d0



WARRANTY	GARANTIA	GARANTIE	GARANZIA	PACKAGING	EMBALAJE	EMBALLAGE	IMBALLAGGIO
Two (2) year limited warranty. Does not cover: incorrect use, bad handling or deliberate damage.	Garantía de dos (2) años limitada. No cubre: mal uso, manipulación o daños intencionados.	Garantie deux (2) ans. À l'exception: mauvaise utilisation, manipulation, dommages intentionnés.	Due (2) anni di garanzie limitati. Non copre: uso improprio, manipolazione o danno intenzionale.	Cardboard box with plastic bag for product protection. Two packages.	Caja de cartón con bolsa de plástico para protección. Dos paquetes.	Boîte en carton avec sac plastique pour la protection. Deux paquets.	Scatola di cartone con sacchetto di plastica per protezione. Dues pacchi.



COLORS







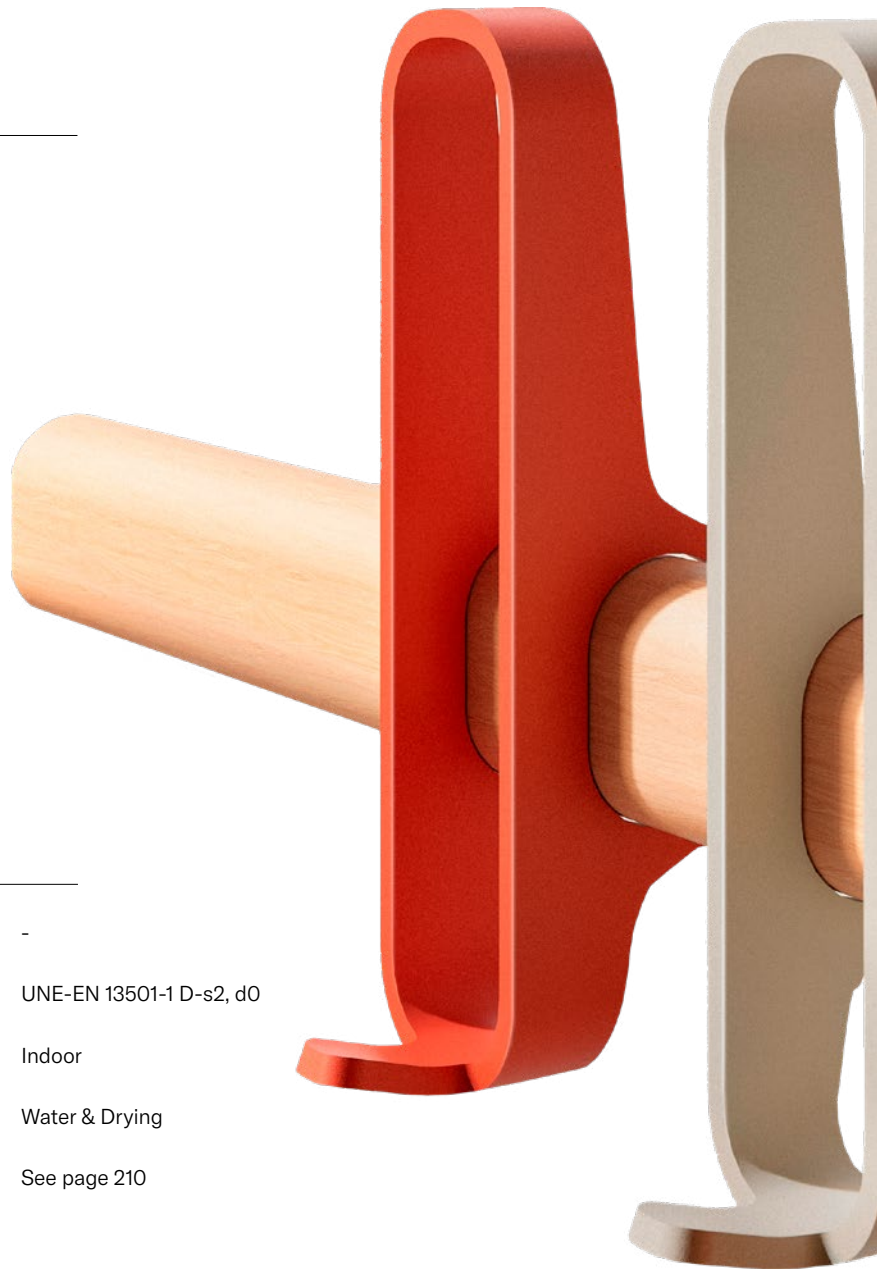

-  PE · Ral 5020
-  GR · Ral 7044
-  RJ · Ral 3016

CUSTOMIZE OPTIONS      PERSONNALISER LES OPTIONS  
 OPCIONES PERSONALIZADAS    OPZIONI DI PERSONALIZZAZIONE

-  H · BEECH WOOD + COLOUR
-  N · WALNUT WOOD + COLOUR



LABELS

Thickness	 -	Acoustic	 -
Material	 Wood + Plastic + Aluminium	Fire resistance	 UNE-EN 13501-1 D-s2, d0
Finish	 Varnished + Injected	Optimal Space	 Indoor
Conductivity	 No	Cleaning	 Water & Drying
		Weight	 See page 210

# Bologna

by Eduard Juanola

**Simple, minimalist and easy to use, it's as if you put some clips on a stand. Made from metal and with five clips in chromed steel that will support even the heaviest backpack, or if you want, with the wooden version you can add warmth to your design. Now you can give your office an original touch!**

*Simple, minimaliste et facile à utiliser, c'est comme si vous mettiez des trombones sur un porte-manteau. Fabriqué en métal et doté de cinq patères en acier chromé qui supporteront même le sac à dos le plus lourd, ou si vous le souhaitez, avec la version en bois, vous donnerez de la chaleur à votre espace. Vous pouvez maintenant donner à votre bureau une touche originale !*

Sencillo, minimalista y fácil de usar, es cómo si pusieras unos clips a un perchero. Fabricado en metal y con cinco clips en acero cromado que soportaran hasta la mochila más pesada, o si quieres, con la versión en madera podrás darle calidez a tu espacio. ¡Ahora sí que podrás darle un toque original a tu oficina!

Semplice, minimalista e facile da usare, ecco come se metti qualche clip a un appendiabiti. Manufatto in metallo e con cinque clip in acciaio cromato che sosterranno fino allo zaino più pesante, o se vuoi, con la versione in legno puoi dare calore al tuo spazio. Ora si puoi dargli un tocco originale per il tuo ufficio!









# More about Bologna

DESIGNER

Eduard Juanola

YEAR

2015 / 2018

LINE SKETCH

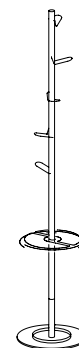

SCALE 1:40 (cm)

PRODUCT

REFERENCE

SIZE

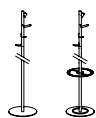

**BOL 01 / 11**

Ø36 x 180 cm  
Ø14,2 x 70,9 in.

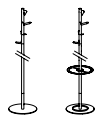

**BOL 10 / 12**

Ø36 x 180 cm  
Ø14,2 x 70,9 in.



**BOL P**

Ø36 x 50 cm  
Ø14,2 x 19,7 in.



BOTTOM HANGER DETAIL – NAP 02 9003

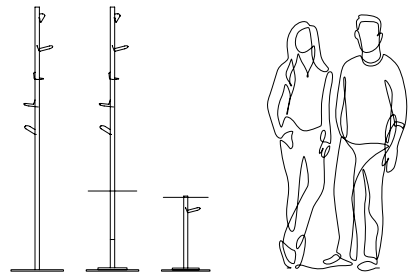

UMBRELLA STAND AND COAT STAND WITH INTEGRATED UMBRELLA HOLDER — BOL P 9003 + BOL 12 9003



COAT STAND



# Bologna

by Eduard Juanola

← VIEW PRODUCT PAGES

368

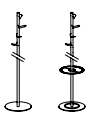
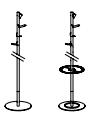
CHARACTERISTICS	CARACTERÍSTICAS	CARACTÉRISTIQUES	CARATTERISTICHE
Coat and umbrella stand made Ø3mm metal or beechwood mast. Hangers made from Ø6mm chromed steel. Weighted base in stamped sheet metal. Unified post and base using screws and includes rubber blocks to protect the surface where it is located.	Perchero de pié y paraguero fabricados en tubo metálico o mástil de madera de haya de Ø30 mm. Colgadores en varilla de acero cromado de Ø6 mm encajadas al tubo. Base en chapa de hierro estampada con peso en la parte inferior. Unión del tubo y base mediante tornillería. Base con tacos de goma para proteger la superficie donde se ubique.	<i>Porte-manteau et porte-parapluie en tube métallique ou mât en bois de hêtre de Ø30 mm. Patères en tige d'acier chromé de Ø6 mm montés sur le tube. Base en tôle emboutie avec poids en partie inférieure. Union du tube et de la base à l'aide de vis. Base avec des gommés en caoutchouc pour protéger la surface où il se trouve.</i>	<i>Appendiabiti di piedi e portaombrelli fabbricato in tubo metallico o albero in legno di faggio Ø30 mm. Ganci per aste acciaio cromato Ø6 mm incorporato al tubo. Base in lamiera di ferro stampata con peso nella parte inferiore. Unione del tubo e della base mediante viti. Base con borchie in gomma per proteggere la superficie dove si trova.</i>

	REF	↕↔	⊕
	<b>BOL 01 / 11</b>	Ø36 x 180 cm Ø14,2 x 70,9 in.	8 kg 17,6 lb.
	<b>BOL 10 / 12</b>	Ø36 x 180 cm Ø14,2 x 70,9 in.  Wooden version	7 kg 15,4 lb.
	<b>BOL P</b>	Ø36 x 50 cm Ø14,2 x 19,7 in.	5 kg 11 lb.







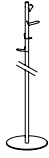









ENVIRONMENTAL IMPACT				FIRE RESISTANCE	RÉSISTANCE AU FEU
				RESISTENCIA AL FUEGO	RESISTENZA AL FUOCO
Materials may be easily disassembled to be recycled.	Materiales fácilmente segregables para su posterior reciclado.	<i>Matériaux facilement démontables pour leurs recyclages.</i>	<i>Materiali facilmente separabile per un successivo riciclaggio.</i>	UNE-EN 13501-1	<b>BOL 01 / 11</b> <b>BOL 10 / 12</b> <b>BOL P</b>  A1-s1, d0 D-s2, d0 A1-s1, d0

WARRANTY	GARANTIA	GARANTIE	GARANZIA	PACKAGING	EMBALAJE	EMBALLAGE	IMBALLAGGIO
Two (2) year limited warranty. Does not cover: incorrect use, bad handling or deliberate damage.	Garantía de dos (2) años limitada. No cubre: mal uso, manipulación o daños intencionados.	<i>Garantie deux (2) ans. À l'exception: mauvaise utilisation, manipulation, dommages intentionnés.</i>	<i>Due (2) anni di garanzie limitati. Non copre: uso improprio, manipolazione o danno intenzionale.</i>	Cardboard box with plastic bag for product protection. Two packages.	Caja de cartón con bolsa de plástico para protección. Dos paquetes.	<i>Boîte en carton avec sac plastique pour la protection. Deux paquets.</i>	<i>Scatola di cartone con sacchetto di plastica per protezione. Dues pacchi.</i>















BRAND COLORS

- |  |   |
|--|---|
|  BL · Ral 9003 |  VD · Ral 6000 |
|  CE · Ral 7033 |  PE · Ral 5020 |
|  GR · Ral 7015 |  AZ · Ral 5009 |
|  AN · Ral 7016 |  BD · Ral 3005 |
|  MA · Ral 8014 |  RJ · Ral 3020 |
|  OP · Ral 1036 |  RS · Ral 2012 |
|  VF · Ral 6020 |  AM · Ral 1007 |
|  VO · Ral 6011 |  NJ · Ral 2017 |

CUSTOMIZE OPTIONS      PERSONNALISER LES OPTIONS  
 OPCIONES PERSONALIZADAS    OPZIONI DI PERSONALIZZAZIONE

-  RAL COLOR
-  NUMBER OF HANGERS

LABELS

- |  |   |
|--|---|
| Thickness  30 mm        | Acoustic  Doesn't absorb sound           |
| Material  Iron          | Fire resistance  UNE-EN 13501-1 B-s1, d1 |
| Finish  Painting        | Optimal Space  Indoor                    |
| Conductivity  100% iron | Cleaning  Water & Drying                 |
|  | Weight  See page 218                     |



# Designers

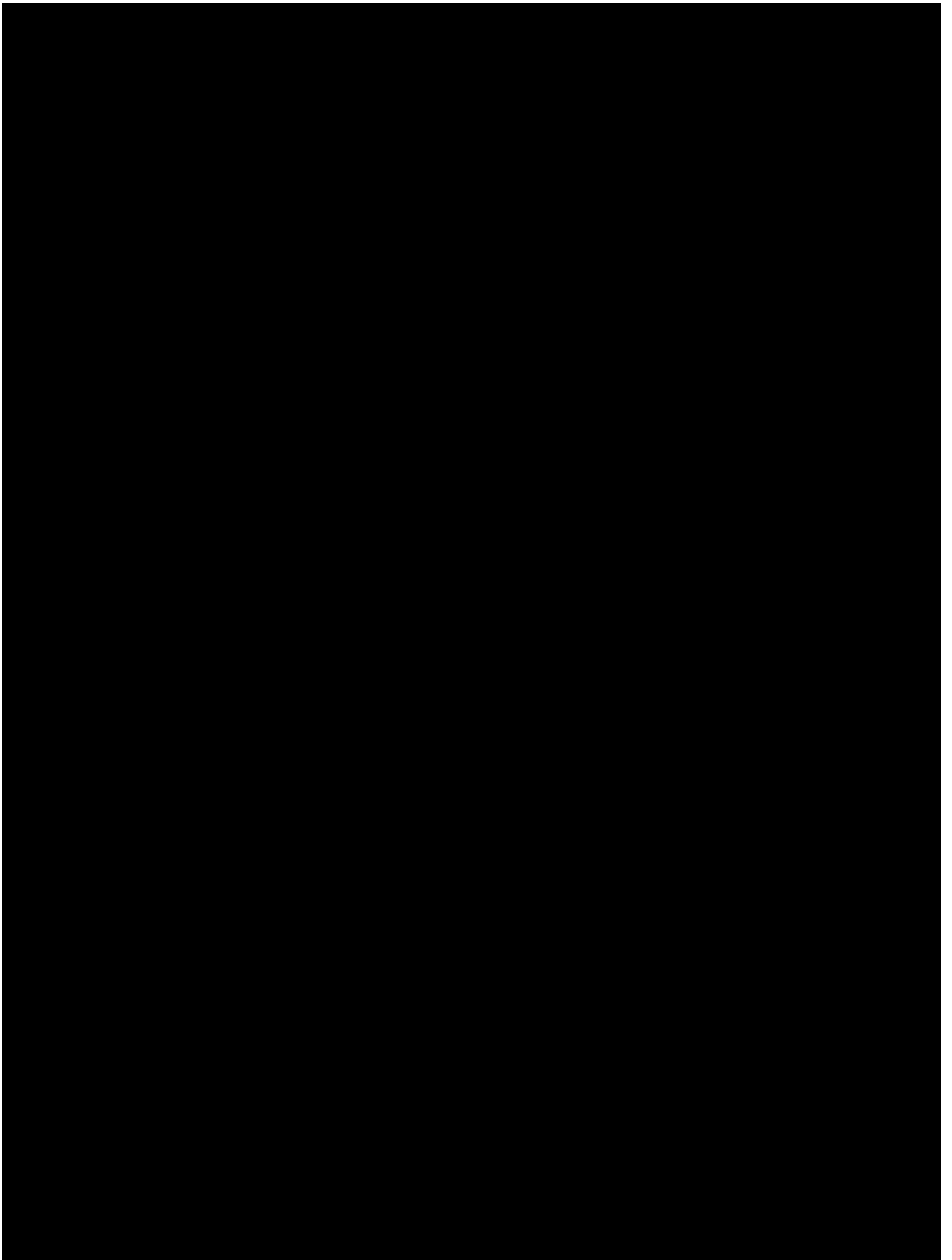

## Alex Fernandez Camps

Saga <sup>228</sup>



A bit of an artist, an architect, a bit of a philosopher, above all a designer and a cyclist. I chose industrial design by intuition, attracted by its human scale and its irremediable sense of reality. Since then, this activity has been surprising me and continues to unfold in each challenge, project by project. I approach each case with the vocational passion of someone who knows that the world is yet to be discovered, enjoying the details of the object, and attending to industrial realities. A pleasure to be part of MD!

Algo de artista, de arquitecto, un poco filósofo, sobretodo diseñador y ciclista. Escogí el diseño industrial por intuición, atraído por su escala humana y su irremediable sentido de realidad. Desde entonces, esta actividad me ha ido sorprendiendo y se sigue desplegando en cada reto, proyecto a proyecto. Abordo cada caso con la pasión vocacional de quien sabe que el mundo está por descubrir, disfrutando de los detalles del objeto, y de atender a las realidades industriales. Un placer participar de MD!

## byBaumgartner

Vevey <sup>48</sup>



Juan Carlos Baumgartner is a Mexican architect and designer grown and formed in Mexico City, San Francisco, Chicago and Milan. He is currently at the head of the international architectural firm Space, with offices in Mexico City, Monterrey and Guadalajara. He has received more than 80 international awards and has been in charge of the design of more than 3 million m<sup>2</sup> in 12 countries. Named by Forbes as one of the "most creative Mexicans in the world" is considered an emblematic architect and pioneer in corporate design in Mexico, recognized as one of the leading futurists in the country. He is currently immersed in research related to neuroarchitecture and his dream is to design spaces that promote happiness, developing architecture to heal the soul.

Juan Carlos Baumgartner es un arquitecto y diseñador mexicano, formado en Ciudad de México, San Francisco, Chicago y Milán. Actualmente al frente de la firma internacional de arquitectura Space, con oficinas en CdMx, Monterrey y Guadalajara. Ha recibido más de 80 premios internacionales y ha estado al frente del diseño de más de 3 millones de m<sup>2</sup> en 12 países. Nombrado por la revista Forbes como uno de los "Mexicanos más creativos del mundo" es considerado un arquitecto emblemático y pionero en el diseño corporativo en México, reconocido como uno de los principales futuristas del país. Actualmente está inmerso en investigaciones relacionadas con NeuroArquitectura y su sueño es diseñar espacios que promuevan la felicidad, desarrollando arquitectura para sanar el alma.

## CrousCalogero

Lugano <sup>138</sup>



Resulting from a collaboration between Francesc Crous and Alessandro Calogero. Professionals of product design that combine their abilities to develop a work that aims to reach the essence of things eliminating that superfluous and always keeping the human being in the centre. This is how they describe their methodology: "We want our objects, the matter and detail of each product, to transmit the desire to be touched and observed closely." Functionality is a basic requirement that we take for granted and about which we try to suggest a story, made of memories and sensations, that generates the impalpable link between object and person. The work of Francesc Crous and Alessandro Calogero has gained international recognition by winning prestigious awards such as the Silver Delta 2012 among others.

CrousCalogero, firma de diseño, es fruto de la colaboración entre Francesc Crous y Alessandro Calogero. Profesionales del diseño de producto que aúnan sus capacidades para desarrollar un trabajo que pretende llegar a la esencia de las cosas eliminando aquello superfluo y manteniendo siempre al ser humano en el centro. Así es como describen su metodología: "Queremos que nuestros objetos, la materia y detalle de cada producto, transmitan el deseo de ser tocados y observados de cerca. La funcionalidad es un requisito de base que damos por sentado y sobre el cual tratamos de sugerir una historia, hecha de memorias y sensaciones, que genere el vínculo impalpable entre objeto y persona." El trabajo de Francesc Crous y Alessandro Calogero ha obtenido reconocimiento internacional ganando prestigiosos premios como el Delta de Plata 2012 entre otros.

## Drop Innovation

Albury <sup>294</sup>



Hello, we are drop. We make tangible innovation through design thinking & design doing. We are a company of Experience Innovation, applied to the creation of new products and services, focused on the user experience and business models. We adapt our services and collaboration models to the needs of the client. With a holistic vision that allows us to generate high added value solutions acting in the three key areas of innovation.

Constituted by a multidisciplinary team, with more than 15 years of accumulated experience in different sectors of design and innovation. We go from strategy to design and implementation. We believe that the “what” is the “how”: it is about how the products / services are brought to market. We collaborate with multinationals, SMEs, start-ups, research centres and universities to develop exceptional and innovative solutions with high impact in the market.

Hola, somos drop. Hacemos la innovación tangible a través del design thinking & design doing. Somos una compañía de Experience Innovation, aplicada a la creación de nuevos productos y servicios, centrados en la experiencia de usuario y los modelos de negocio. Adaptamos nuestros servicios y modelos de colaboración a las necesidades del cliente. Con una visión holística que nos permite generar soluciones de alto valor añadido actuando en las tres áreas clave de la innovación. Constituida por un equipo multidisciplinar, con más de 15 años de experiencia acumulada en diferentes sectores del diseño y la innovación. Vamos desde la estrategia al diseño y la implementación. Creemos que el “qué” es el “cómo”: se trata de cómo se llevan los productos/servicios al mercado. Colaboramos con multinacionales, PyMES, start-ups, centros de investigación y universidades para desarrollar soluciones excepcionales e innovadoras con alto impacto en el mercado.

## Eduard Juanola

Torino <sup>344</sup>  
Napoli <sup>352</sup>  
Bologna <sup>368</sup>



Industrial Designer trained at the EDI IN Sabadell Catalonia and now resident in Barcelona. Today he is the design director at Crea Product Design and is also avising profesor at the Elisava School of Design.

His Designs are the result of finding exactly the right solution to satisfy the most demanding design briefs, investigating until the right solution is found and the client is satisfied on every occasion.

Diseñador industrial formado en la escuela EDI de Sabadell e instalado en Barcelona. Dirige el estudio Crea Product Design y es profesor en la escuela Elisava. Su diseño es el resultado de la combinación adecuada de recursos por satisfacer las necesidades del usuario y la empresa, al mismo tiempo ofrece un carácter emotivo a este encuentro. Minucioso con los detalles y la investigación de la solución óptima para cada ocasión.

## Estudi Ribaudí

Zell <sup>82</sup>



Estudi Ribaudí works with tools, makes them grow and transforms them into objects. Led by Jordi Ribaudí, his creative proposals mix creativity, mastery and technology creating objects with identity. His studio works with companies from different sectors offering fresh proposals capable of connecting with people. They also collaborate with well-known fashion brands, creating new retail concepts and shopping experiences.

Beyond the product design, the studio is promoting the REC.0 Experimental Stores project since 2009. The objective is to recover the industrial architecture of the Rec d'Igualada neighborhood, with the installation of ephemeral “pop-up” stores. Last 2016, Ribaudí launched its own furniture producer, Toru. To work and experiment with the leather that is manufactured in Igualada since centuries ago, is its original motivation.

Estudi Ribaudí trabaja con las herramientas, las hace crecer y las transforma en objetos. Liderado por Jordi Ribaudí, sus propuestas creativas mezclan creatividad, maestría y tecnología creando objetos con identidad. Su estudio trabaja con empresas de diferentes sectores ofreciendo propuestas frescas capaces de conectar con las personas. También colaboran con conocidas marcas de moda, creando nuevos conceptos de retail y experiencia de compra. Más allá del diseño de producto, el estudio impulsa des de 2009 el proyecto REC.0 Experimental Stores. El objetivo es recuperar la arquitectura industrial del barrio Rec de Igualada, con la instalación de tiendas de “pop-up” efímeras. El pasado 2016, Ribaudí lanzó su propia productora de mobiliario, Toru. Trabajar i experimentar con el cuero que se fabrica en Igualada des de hace siglos, es su motivación original.

## Ferran Guimerà

Niseko <sup>260</sup>



Passionate about sports and fascinated by the world of design and innovation. For some years now, his curious and creative mind has led him to explore the aesthetics and functionality of everyday objects, where design is more than creating beautiful objects; it is telling a story through every detail, every choice of material and every aspect of the manufacturing process.

After finishing his studies in Industrial and Product Design in 2013, he started an adventure through Germany and Switzerland, where he was able to learn and carry out different design projects. Currently in Barcelona, he is focused on the world of contract and sports design.

Apasionado del deporte y fascinado por el mundo del diseño y la innovación. Desde hace unos años, su mente curiosa y creativa le ha llevado a explorar la estética y la funcionalidad de los objetos cotidianos, donde el diseño es más que la creación de objetos bonitos; es contar una historia a través de cada detalle, de cada elección de material y de cada aspecto del proceso de fabricación.

Después de acabar los estudios de Diseño industrial y producto en 2013, inició una aventura por Alemania y Suiza, donde pudo aprender y realizar distintos proyectos de diseño. Actualmente en Barcelona, está enfocado en el mundo del diseño contract y deportivo.

## Gauzak

Naka <sup>156</sup>



Gauzak is a product design studio established in 2011. Its founding partners, Arkaitz Arco, Juan T. Carboneras and Leire Pérez, met during their industrial design studies at La Escola Massana (Barcelona).

Since then, they have developed its activity in different areas with projects for national and international clients, which led the studio to gain experience, knowledge and a mature cross sectional perspective of design and its client's needs. Gauzak faces new challenges understanding design as a tool that must be open to people and companies. A creative and functional service focused on users, companies and their brands.

Somos un estudio de diseño de producto constituido en el año 2011. Sus socios fundadores somos Arkaitz Arco, Juan T. Carboneras y Leire Pérez y nos conocimos durante nuestros estudios de diseño industrial en La Escola Massana (Barcelona). Desde entonces hemos desarrollado nuestra actividad en diversos sectores con proyectos para clientes nacionales e internacionales, lo que nos ha permitido acumular experiencias y conocimientos y madurar una mirada transversal sobre las necesidades de diseño de cada uno de nuestros clientes.

Nos gusta afrontar nuevos retos entendiendo el diseño como un servicio que debe estar al alcance de personas y empresas: una herramienta creativa, funcional y focalizada sobre el usuario, las empresas y sus marcas.

## Gemma Bernal

Go <sup>190</sup>



Gemma Bernal has been designing since 1968. Practicing design as well as teaching it has occupied most of her life. She believes in Design as a collaboration with Companies, as a way to offer the market new and differentiated products, with clear arguments and values.

Her designs are simple and timeless. She always tries to start from a suggestive idea, with a solid base; many times with movements, mechanisms, etc. that facilitate their use and are easily understandable. Gemma feels a deep love for her profession and tries to share this passion with her team of young people and with the companies she works with. Many years in her work have given her experience, maturity and tolerance. She strives to adapt to technological changes and use them to her advantage. She believes that a Project is not the result of just the Designer, but of the entire Company team that participates in its creation and of everyone who has been involved until the product hits the market.

Gemma Bernal diseña desde el año 1968. Practicar el diseño además de enseñarlo ha ocupado la mayor parte de su vida. Cree en el Diseño como colaboración con las Empresas, como una forma de ofrecer al mercado productos nuevos y diferenciados, con argumentos y valores claros.

Sus diseños son simples y atemporales. Siempre intenta partir de una idea sugerente, con una base sólida; muchas veces con movimientos, mecanismos, etc que facilitan su uso y son fácilmente comprensibles.

Gemma siente un profundo amor por su profesión e intenta compartir esta pasión con su equipo de jóvenes y con las empresas con las que trabaja. Muchos años en el trabajo, le han dotado de experiencia, madurez y tolerancia. Se esfuerza por adaptarse a los cambios tecnológicos y utilizarlos a su favor. Cree que un Proyecto no es fruto sólo del Diseñador, sino de todo el equipo de la Empresa que participa en su creación y de todos los que han estado involucrados hasta que el producto sale al mercado.

## Joan Cinca

Obliqua <sup>302</sup>



Product designer with a degree from the Polytechnic University of Catalonia and a Master's in Entrepreneurship and Innovation from Pompeu Fabra University in Barcelona. He began his career in the automotive sector and later specialized in product design. He has collaborated with national and international companies in sectors such as lighting, consumer products, and furniture. His relationship with companies is based on trust and full involvement, empathizing with the client's desires and creatively solving their needs. His work process focuses on reflection and iteration, aiming to create products that, in addition to meeting the expectations of the client and the end consumer, provide innovative and surprising solutions. His designs seek to balance timelessness and modernity. Among his most notable projects, he has received awards such as the Red Dot Design Award, the Delta Silver Award, the German Design Award, and the Good Design Award.

Diseñador de producto licenciado por la Universidad Politècnica de Catalunya y máster en Emprendeduría e Innovación por la Universidad Pompeu Fabra de Barcelona. Inició su carrera en el sector de la automoción y, más adelante, se especializó en el diseño de producto. Ha colaborado con empresas nacionales e internacionales en sectores como la iluminación, productos de consumo y mobiliario. La relación con las empresas se basa en la confianza y una implicación total, empatizando con los deseos del cliente y resolviendo creativamente sus necesidades. Su proceso de trabajo se centra en la reflexión y la iteración, con el objetivo de crear productos que, además de cumplir con las expectativas del cliente y del consumidor final, aporten soluciones innovadoras y sorprendentes. Sus diseños buscan equilibrar la atemporalidad y la actualidad. Entre sus proyectos más destacados, ha recibido reconocimientos como el Red Dot Design Award, el Delta de Plata, el German Design Award y el Good Design Award.

## Joan Gaspar

Nagoya <sup>236</sup>  
Kyoto <sup>172</sup>  
Zurich <sup>64</sup>



I began to learn the craft of designing under the guidance of Lluís Porqueras at the end of the 80s. Today, I am a seasoned professional, but one who often thinks that his designs still retain the essence of those early years, given that I am still more interested in explaining how I have done things and showing how I have solved problems, rather than in the end result per se. That is not to say that the end result does not interest me, obviously it is very important, but, since the solution, about which everyone has their own opinion, is apparent, I feel that no one, other than its creator, can explain its hidden secrets knowledgeably and with passion.

Aprendí el oficio de diseñador industrial de la mano de Lluís Porqueras a finales de la década de los 80. Hoy soy un profesional maduro, que normalmente piensa que sus trabajos aun mantienen el espíritu de aquellos primeros años, teniendo en cuenta que me sigue interesando más hablar de como he realizado las cosas y como las he resuelto que el resultado final; y no porque el resultado final no me interese, en realidad es realmente importante, sino porque el resultado final es obvio y hay que dejar que se juzgue, y los detalles invisibles solamente el autor los puede explicar con conocimiento y pasión.

## Lagranja Design

Milard <sup>360</sup>



Founded in 2002, Lagranja is a multidisciplinary design firm whose talents are primarily focused on creating interiors and products. After almost 18 years, Lagranja's team remains passionate and coherent with its philosophy: to convert design into a companion for enterprises and brands. Designing at Lagranja has always been a matter of ideas and strategies, never of trends. "We won't sit at the table with a predetermined list of what we should or shouldn't do. We believe that every project is unique and has to be approached in a different way. We try to understand the context, we ask a lot of questions, to ourselves and also to our client, we strategize, we look for the right tools and the right team. And we let things be born."

Fundada en 2002, Lagranja es una firma de diseño multidisciplinar cuyo talento se centra principalmente en la creación de interiores y productos. Después de casi 18 años, el equipo de Lagranja sigue siendo apasionado y coherente con su filosofía: hacer del diseño un acompañante de empresas y marcas. Diseñar en Lagranja siempre ha sido una cuestión de ideas y estrategias, nunca de tendencias. "No nos sentaremos en la mesa con una lista predeterminada de lo que debemos o no debemos hacer. Creemos que cada proyecto es único y tiene que ser abordado de una manera diferente. Tratamos de entender el contexto, nos hacemos muchas preguntas, a nosotros mismos y también a nuestro cliente, trazamos estrategia, buscamos las herramientas adecuadas y el equipo adecuado. Y dejamos que las cosas nazcan."

## La Mamba Studio

Bergamo <sup>312</sup>



In 2008 Raúl Durá, Ommar Uribe and Pedro Rivera founded La Mamba studio, established to offer product design projects and branding to the furniture and lighting industry, as well as art direction and consultancy.

By 2012, having acquired the necessary experience, they decided to create their own product editing company for habitat and contract, Omelette-ed, in order to achieve the development of products based on usability analysis, materiality and sustainability, as well as a visual reduction process.

En 2008 Raúl Durá, Ommar Uribe y Pedro Rivera fundan La Mamba studio ofreciendo servicio a empresas del sector del mueble y la iluminación, desarrollando proyectos de diseño de producto y branding, así como la dirección de arte y asesoramiento de empresas. En el año 2012, tras su experiencia en el sector, deciden montar su propia editora de productos para el hábitat y colectividades (Omelette-ed), tratando de desarrollar de esta manera productos que se basan en análisis de usabilidad, la materialidad, la sostenibilidad y un proceso de reducción visual.

## Mar Vaíllo

Osaka <sup>244</sup>



Born in Barcelona with an education in fine arts and industrial design over the years designing and developing products in many instances for the technical sector. He works in the studios of Alberto Liévore and above all Ramón Benedito.

She has been teaching at the Elisava School in Barcelona and the Esdi School in Sabadell. In 2012 she founded her own company together with Artur Llorens. The showcases made for the store of the Guggenheim Museum Bilbao and the signage of the Mémora Group Tanatoria stand out as projects. Interested in everyday design, affordable and that which brings us happiness in our daily lives; he admires the breakthrough designs that make us advance, and he despairs to see the world flooded with so many versions of the same object.

Nacida en Barcelona, con formación en Bellas Artes y en diseño industrial.

Durante años diseña y desarrolla producto, muchas veces de sectores técnicos. Trabaja en los estudios de Alberto Liévore y sobretodo Ramón Benedito.

Ha sido profesora de la Escuela Elisava de Barcelona y la Escuela Esdi de Sabadell. En 2012 funda con Artur Llorens su propia empresa de equipamiento integral de espacios. Destacan como proyectos las vitrinas realizadas para la tienda del Museo Guggenheim Bilbao y la señalización de los Tanatorios del Grupo Mémora.

Interesada en el diseño cotidiano, asequible y aquél que nos aporta felicidad en nuestra vida diaria; admira los diseños rompedores que nos hacen avanzar, y le desespera ver el mundo inundado de tantas versiones de un mismo objeto.

## Mario Ruiz

Menfis <sup>268</sup>



Born in 1965 in Alicante, Spain, designer Mario Ruiz graduated in Industrial Design from Barcelona's prestigious Elisava Design School. He started his independent professional career in 1995 opening his own studio in Barcelona.

Projects directly related to their products in different fields (domestic and office furniture, lighting, textile design, product design) but also acts as creative director defining their product.

Nacido en Alicante en 1965, el diseñador Mario Ruiz se graduó en Diseño Industrial de la prestigiosa Escuela de Diseño Elisava de Barcelona. Comenzó su carrera profesional independiente en 1995 abriendo su propio estudio en Barcelona.

Proyectos relacionados directamente con sus productos en diferentes campos (mobiliario doméstico y de oficina, iluminación, diseño textil, diseño de producto), pero también actúa como director creativo definiendo su producto.



## Muka Design Lab

Oslo <sup>210</sup>



Muka Design Lab is an award-winning industrial design studio specialised in creating furniture with identity and character. Located in Bilbao since 2011. The founders, Laxmi Nazabal and Lucas Abajo, graduated in Fine Arts and Industrial Design Engineering, both with a Master's degree in product design from Coventry University in England. Their work has been featured in AD Architectural Design, Fast Company, Archi Expo, Dezeen, El País and awarded at international design exhibitions in Milan and Los Angeles, as well as winning a RedDot Award Design Concept in 2015 and a German Design Award in 2020. In 2019 they created a furniture publisher called Abana Bilbao, where they design, manufacture and sell exclusively online products with an Atlantic and Nordic identity, made with local craftsmen and materials.

Muka Design Lab es un estudio de diseño industrial galardonado con diferentes premios, especializado en crear mobiliario con identidad y carácter. Ubicado en Bilbao desde 2011. Los fundadores, Laxmi Nazabal y Lucas Abajo, licenciada en Bellas Artes e Ingeniero en Diseño Industrial, ambos con Máster en diseño de producto por la Universidad de Coventry en Inglaterra. Su trabajo ha sido destacado en AD Architectural Design, Fast Company, Archi Expo, Dezeen, El País y premiado en exposiciones internacionales de diseño en Milán y Los Ángeles, así como galardonado con un RedDot Award Design Concept en 2015 y un German Design Award en 2020. En 2019 crearon una editora de mobiliario llamada Abana Bilbao, donde diseñan, fabrican y venden exclusivamente online productos con identidad Atlántica y nórdica, realizados con artesanos y materiales locales.

## Nahtrang

Davos <sup>24</sup>  
Siena <sup>328</sup>



Nahtrang is a design studio located in Barcelona since 2004. The founders, Daniel Vila and Ester Pujol, both industrial designers by the Escola Massana (Barcelona), are the soul of the office. Throughout a 14-year career they have worked on a variety of projects such as lighting, bathroom accessories, furniture and urban furniture, always maintaining their philosophy; sincere designs, clean and simple lines creating a very direct language. This has led them to obtain public recognition through awards such as the ADI of Plata'12, as the NYC X Design 2017, the Restaurant & Bar Product Design Award 2017 or the German Design Award 2018. Their products have appeared in various publications such as Interior Design, Pin-Up, ON Design, Experimenta, Icon or Wallpaper, Metropolis USA among others.

Nahtrang es un estudio de diseño ubicado en Barcelona desde el 2004. Los fundadores, Daniel Vila y Ester Pujol, ambos diseñadores industriales por la Escola Massana (Barcelona), son el alma de la oficina. A lo largo de una carrera de 14 años han trabajado en diversidad de proyectos como la iluminación, accesorios de baño, mobiliario y mobiliario urbano manteniendo siempre su filosofía; diseños sinceros, de líneas limpias y sencillas creando un lenguaje muy directo. Esto les ha llevado a obtener el reconocimiento público mediante premios como el ADI de Plata'12, el NYC X Design 2017, el Restaurant & Bar Product Design Award 2017 o el German Design Award 2018. Sus productos han aparecido en diversas publicaciones como Interior Design, Pin-Up, ON Diseño, Experimenta, Icon o Wallpaper, Metropolis USA entre otros.

## Pep Puerto

Basilea <sup>74</sup>



Pep Puerto understands design from the most technical detail to the esthetics, its function and utility. Simple elegant designs, his products define his vision and his personality. Pep has accompanied us for many years now at Planning Sisplamo and now Made Design Barcelona guiding and teaching us, Pep considers this company his home away from home.

Pep Puerto entiende el diseño desde la parte más técnica hasta la estética del producto, su función y su utilidad. El diseño sencillo y elegante de sus productos define su visión y personalidad. Pep nos acompañó durante muchos años en Planning Sisplamo y Made Design Barcelona, guiándonos y enseñándonos. Un hombre que puede considerar esta empresa su casa.

## Plumartis

Interlaken<sup>90</sup>  
Thun<sup>106</sup>



Plumartis is a design study funded in 2010 by Jordi Ventura and Bernat Faura, located in the beautiful Parc del Garraf, overlooking the city of Barcelona and the Mediterranean Sea.

We design and develop new products, focusing on the small details that bring value and innovation. Our experience in the engineering and industrial field gives us an integral vision of the product and it allows us to define the manufacturing processes needed, as well as the materials proposed.

At Plumartis we aim to reduce the environmental impact in every stage of the projects in which we participate, designing with this fundamental pillar in mind from conceptualisation to manufacturing.

Plumartis es un estudio fundado el 2010 por Jordi Ventura y Bernat Faura. Está ubicado en el Parque Natural del Garraf con vistas a la ciudad de Barcelona y al mar. Disfrutamos diseñando y desarrollando producto, centrándonos en los pequeños detalles que aportan valor e innovación al proyecto.

La dilatada experiencia en el ámbito industrial en sectores muy diversos, nos aporta una visión integral del producto al mismo tiempo que nos permite definir y aportar innovación tanto a nivel de los procesos productivos como de los materiales que confieren el producto.

En Plumartis trabajamos siempre para reducir el impacto ambiental de los productos y procesos en los que participamos, siendo éste apartado un pilar fundamental a la hora de conceptualizar y proyectar.

## Roger Vancells

Baden<sup>98</sup>  
Milano<sup>320</sup>  
Nyon<sup>32</sup>  
Nyon Planter<sup>180</sup>  
Padova<sup>336</sup>  
Fuji<sup>202</sup>



His Industrial Design education in ESDAP Llotja and Escola Massana, his work, both in product design and spaces, has the vocation of helping brand growth creating singular experiences that have emotional connections with users.

The working method has impact revealing the beauty of everyday objects making them simple, useful and clear, constantly innovating using truthful but also finding attractive solutions.

Formado como diseñador industrial en ESDAP Llotja y en Escola Massana, su trabajo, tanto en el diseño de producto como de espacios, tiene la vocación de ayudar al crecimiento de las marcas y conseguir generar experiencias singulares que tiendan conexiones emocionales con las personas que acaban utilizándolos.

El método de trabajo incide en conseguir revelar la belleza de las cosas cotidianas haciéndolas sencillas, funcionales y claras, utilizando para ello soluciones atractivas, sinceras y fruto de una mirada constante hacia la innovación.

## Rono

Friburg<sup>130</sup>



The idea was born from necessity, and from necessity a new design mission was born for Camille, Christine and Bruno and Romain who until then had never imagined being considered as such. Complementary and self-taught, these entrepreneurs embody the notion of a family business and, therefore, the concept of “designing” as a family. His first creation is a pure and clear translation of the very definition of design: providing solutions to everyday problems, small and large, linked to economic, social and environmental issues. Therefore, it was not a surprise to become interested in the problem of selective classification to rethink part of ecotourism. With the desire to offer the best for everyone, their work is guided by common sense and anchored in the reality of our daily lives.

La idea nació de la necesidad, y de la necesidad nació una nueva misión de diseño para Camille, Christine y Bruno y Romain que hasta entonces nunca habían imaginado ser considerados como tales. Complementarios y autodidactas, estos emprendedores encarnan la noción de empresa familiar y, por tanto, el concepto de “diseñar” en familia. Su primera creación es una traducción pura y clara de la definición misma de diseño: brindar soluciones a problemas cotidianos, pequeños y grandes, vinculados a cuestiones económicas, sociales y ambientales. Por lo tanto, no fue una sorpresa interesarse por el problema de la clasificación selectiva para repensar parte del ecoturismo. Con el afán de ofrecer lo mejor para todos, su trabajo está guiado por el sentido común y anclado en la realidad de nuestro día a día.

## Stone Designs

Berna <sup>56</sup>  
Laax <sup>146</sup>  
Nipori <sup>164</sup>  
Zao <sup>252</sup>



Stone Designs is the story of two people (Cutu Mazuelos 1973 and Eva Prego 1974), and their career spanning over twenty-years. During this time they have developed a huge variety of projects, from a personal perspective and without censure. This approach has allowed Stone Designs to give expression to its essence in every challenge faced. All this makes Stone Designs a dedicated studio, with a passion for design and for life.

Stone Designs responde a la historia de sus dos creadores (Cutu Mazuelos 1973 y Eva Prego 1974), y sus más de veinte años de carrera. Tiempo en el que ha desarrollado multitud de proyectos desde una perspectiva personal, sin censura ni filtros. Este modo de afrontar su trabajo ha hecho que durante todo este tiempo, Stone Designs haya sido capaz de plasmar su esencia en cada uno de los proyectos a los que se ha enfrentado. Stone Designs es ya un estudio consolidado pero no por ello menos entregado a su actividad, que es a la vez su pasión y razón de su existencia.

## Toni Arola

Lausanne <sup>40</sup>



Was born in Tarragona in 1960 and currently lives in Barcelona. He studied at Eina school in Barcelona, and in 1984 he began his professional career at Estudi Lievore i Pensi, and later at AD Associate Designers. In 1994 he founded Estudi Antoni Arola.

His projects are diverse: they go from lighting projects for various publishers such as Santa & Cole, Vibia, Viabizzuno, to pieces of furniture, perfume packaging, interior design and ephemeral installations.

His eternal and continuous research for beauty, inspired by ancestral cultures and his particular vision of light, gives him a unique versatility that filters through each and every project.

Among the awards he has won are the National Design Award in 2003, four times with a Silver Delta Award and in 2018 with a Red Dot: Best of The Best.

Nace en Tarragona en 1960 y actualmente vive en Barcelona. Estudió en la escuela Eina de Barcelona, en 1984 inicia su carrera profesional en el Estudio Lievore y Pensi, y posteriormente en AD Associate Designers. En el 1994 funda Estudi Antoni Arola.

Sus proyectos tocan campos muy diversos: proyectos de iluminación para diversas editoras como Santa&Cole, Vibia, Viabizzuno, piezas de mobiliario, envases de perfumes, proyectos de interiorismo e instalaciones efímeras.

Su eterna y continua búsqueda de la belleza, inspirada en las culturas ancestrales y en su particular visión de la luz, le confieren una versatilidad singular que filtra a través de cada proyecto.

Entre otros premios ha estado galardonado con el Premio Nacional de Diseño 2003, cuatro veces con un Premio Delta de Plata y en el año 2018 con un Red Dot: Best of The Best.

## Toni Pallejà

Sapporo <sup>286</sup>



Toni Pallejà studied industrial design at the Eina school, Porcuatro where he teaches. After working in industrial design he now works in fashion design and accessories and is currently developing activities for several clients including Carpyen, Barcelona City Council, Decap, RNB Cosmetics and Apr Jané where he is creative director .

Toni Pallejà estudió diseño industrial en la escuela Eina, donde actualmente Porcuatro ejercen de docentes. Después de trabajar en estudios de diseño industrial y en el campo de diseño de complementos de moda, actualmente desarrolla su actividad para clientes como Carpyen, Ajuntament de Barcelona, Decap, Rnb Cosmetics, Jané o Abr donde se encarga de la dirección creativa.

## Ximo Roca Design

Biel <sup>114</sup>



Although his professional career began in 1981 it wasn't until 1989 that the Ximo Roca Design studio was established.

His work is characterized by an initial immersion in the reality of business helping him to understand the markets that they address. Analysis of their production systems, their capacity and their economic potential... thus he can offer each customer a service of realistic, concrete and specific design. The design will accommodate the market, and not the design.

His desire is that his work will allow companies to compete in the market more competitively and this is one of his constant concerns.

His projects both national and international and ranging from industrial design, graphic design to interior design and architecture.

Aunque su trayectoria profesional se inició en 1981, fue en 1989 cuando se creó el estudio Ximo Roca Diseño. Su trabajo se caracteriza por una inmersión inicial en la realidad empresarial de los clientes y por entender el mercado al que ellos se dirigen. Analiza sus sistemas de producción, su capacidad, su potencial económico... de este modo puede ofrecer un servicio de diseño realista, concreto y específico a cada cliente. El diseño se acomodará al mercado y no éste al diseño. Pretende que su trabajo permita a las empresas concurrir en el mercado más competitivamente y ésta es una de sus constantes preocupaciones.

Sus proyectos, tanto de ámbito nacional como internacional, abarcan desde el diseño industrial y el diseño gráfico al interiorismo y la arquitectura.



# Colors & finishes

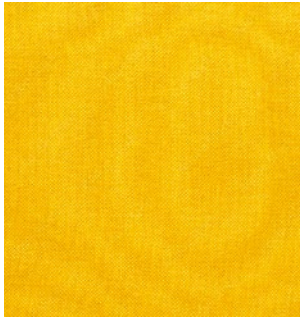

**TEXTILES**



**SURFACES**

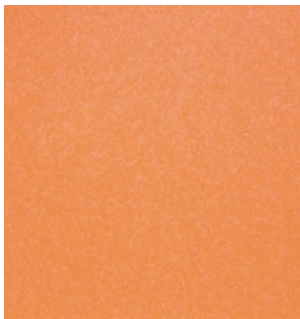

**PLASTICS**



**METAL**

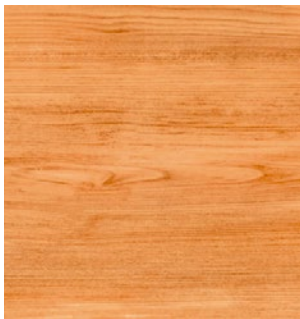

**WOOD**



**VINYLS**

# TEXTILES

---

## ACOUSTIC PET

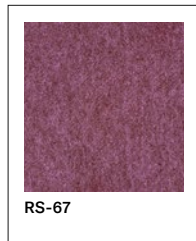
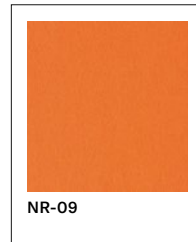
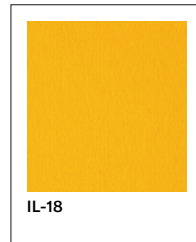
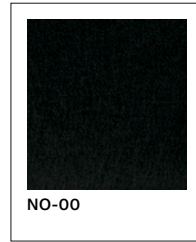
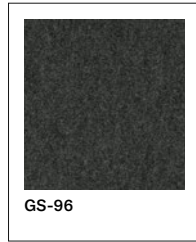
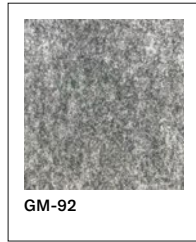
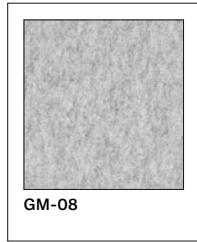
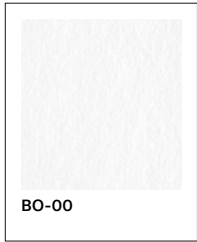

---

## TEXTILE FUJI HUSH STRIPE 40 by Gabriel

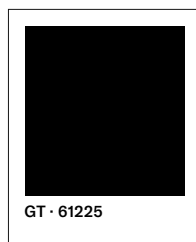
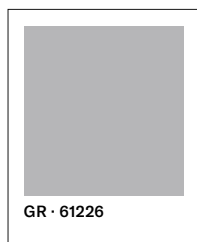
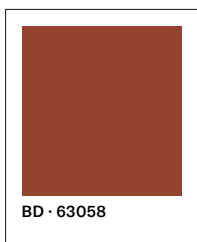
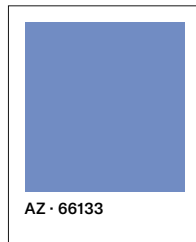
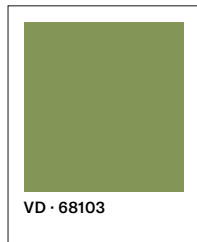
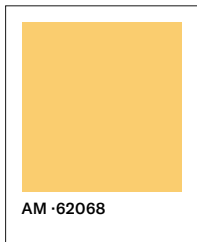



## SURFACES

---

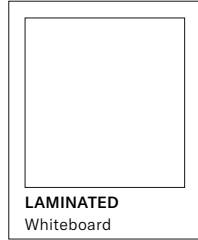
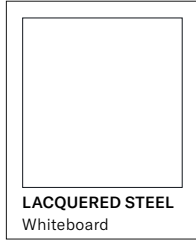
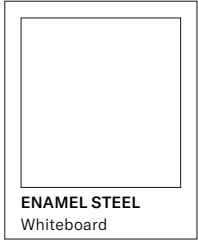

## PLASTICS

---

### BIEL'S INJECTION

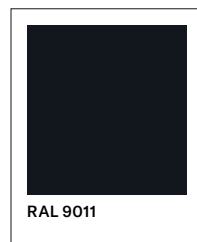
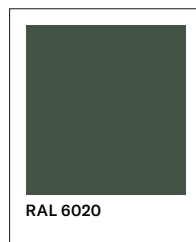
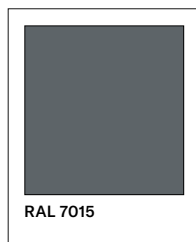
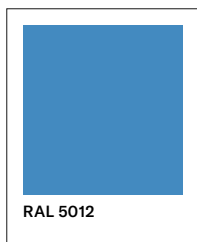
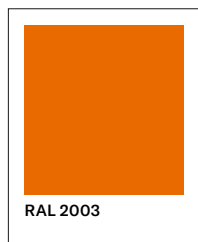
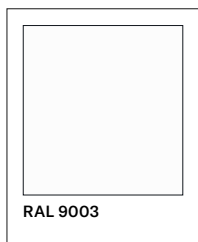

---

### HANGER PARTS' INJECTION

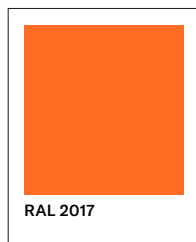
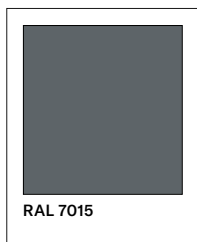
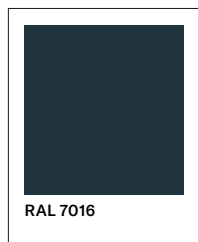
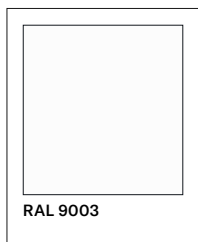

---

### MILARD'S INJECTION

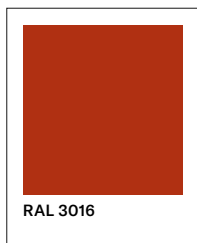
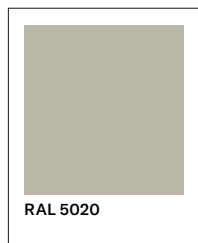
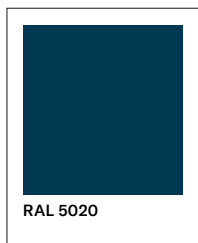

---

### KYOTO'S ROTOMOLDED

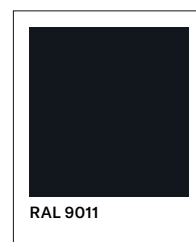
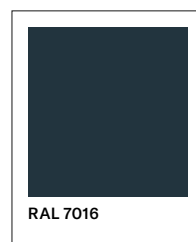
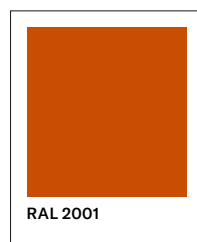
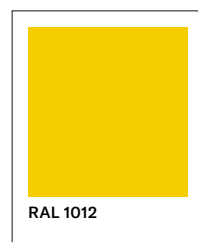
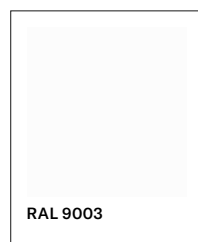

# METAL

---

## LACQUERED COLORS



---

## RECYCLING STANDARD COLORS

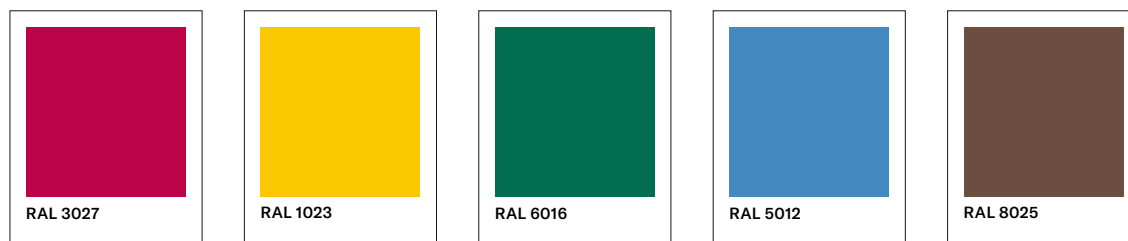

# WOOD

---

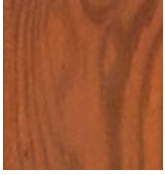

**WOOD · NYO**  
Pine



**WOOD · MIL, BRG, SIE**  
Beech Wood



**WOOD · MLR**  
Beech Wood

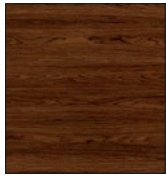

**WOOD · MLR**  
Beech Wood (Walnut)

# VINYLS

---

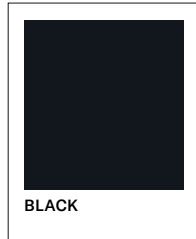
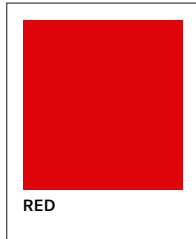
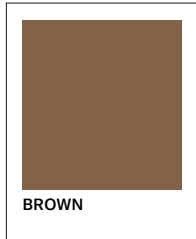
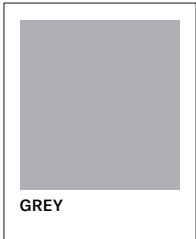
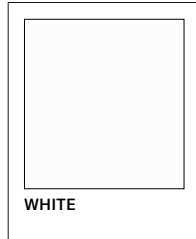
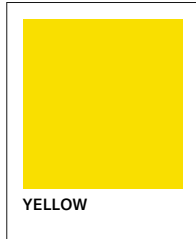
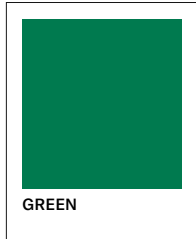
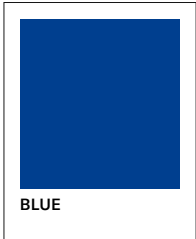

# Downloads

**What you need to finish your project is here...**

Lo que necesitas para terminar tu proyecto está aquí...

*Ce dont vous avez besoin pour terminer votre projet est ici...*

Ciò di cui hai bisogno per completare il tuo progetto è qui...





CATALOG

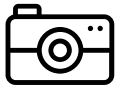

IMAGES



CERTIFICATES



TECHNICAL



FINISHES



AUTOCAD



REVIT/BIM

**PC**

PCON PLANNER

# Credits



---

**Special thanks**

Alex Circuns, Camilo Herrera, Carolina Chica,  
Dani Trias, Edu Martínez and Laura Ortiz.

---

**Photography**

Befree Studio

**Rendering**

Dani Trias, Camilo Herrera

---

## Headquarters

Polígono Industrial Pla d'en Coll  
Camí de la Font Freda 17, Nave 4  
08110 Montcada i Reixac  
Barcelona, Spain

---

T. +34 935 616 595

info@madedesign.es  
[www.madedesign.es](http://www.madedesign.es)

follow us  
[@made\\_design](https://twitter.com/made_design)



ER-0209/2021

GA-2021/0082

## Our brands

 **Planning Sisplamo**  
[planningsisplamo.com](http://planningsisplamo.com)

**made design**  
[madedesign.es](http://madedesign.es)

**DLIMIT™**  
[dlimit.net](http://dlimit.net)

**Mobles114**  
[mobles114.com](http://mobles114.com)



---

## Headquarters

Polígono Industrial Pla d'en Coll  
Camí de la Font Freda 17, Nave 4  
08110 Montcada i Reixac  
Barcelona, Spain

---

[www.madedesign.es](http://www.madedesign.es)

follow us

@made\_design

is part of

 Planning Sisplamo



ER-0209/2021

GA-2021/0082