

# *Jungla collection*

---

DB, DUMBBELL, LA ISLA, MOUSSE,  
MULLIT, NIDO, TONELLA, TORTUGA

---

**SANCAL** 





# Jungla collection

SANCAL 

***Por el lado más bestia de la vida...***

Jungla Collection se inspira en la riqueza y profusión de la naturaleza en su estado más salvaje, en sus claroscuros, en sus colores vibrantes, en su aleatoriedad, en sus formas imposibles y también en sus límites y en cómo los hemos transgredido.

Con el sentido del humor que caracteriza a la marca, el Estudio Sancal reinterpreta la idea de naturaleza y pone a nuestra disposición una jungla falsa, con vegetaciones ilustradas y fieras acolchadas. “De algún modo, queremos manifestar que lo salvaje ya no es la naturaleza, lo realmente feroz es el homo urbanus”.

***Take walk on the wild side...***

Jungla Collection has been inspired by nature in its wildest state, in its chiaroscuros, its vibrant colours, in its randomness, in its impossible forms and also in its limits and how we have transgressed them.

Estudio Sancal reinterprets nature with the sense of humor that characterizes the firm to present a scenography that represents a jungle with illustrated vegetation and wild fluffy beasts. “The wild” is no longer nature. What is really fierce is “homo urbanus”.



**MOUSSE** 06 - 25



**DB** 26 - 33



**MULLIT** 34 - 39



**NIDO** 48 - 55



**TONELLA** 40 - 47



**TORTUGA** 62 - 67



**LA ISLA** 68 - 75



**DUMBBELL** 56 - 61



---

**COSAS** 82 - 83





# DESIGNERS

## RAFA GARCÍA

Rafa forma parte del corazón creativo de **Sancal**, y es autor de piezas ya clásicas para la marca como **Air** o **Eleva**. En cuanto a sus creaciones más recientes cabe destacar el aclamado **Tiptoe** y el singular **Obi**. Tras los exitosos **Rock**, **Nido** y **Folk**, nos propone un diseño altamente racional.



Rafa sits at the creative heart of **Sancal** and is the author of some of the firm's perennial designs like the **Air** or **Eleva**. His latest creations include the **Tiptoe** and the unique **Obi**. Building on the success of products like the **Rock**, **Nido** and **Folk** he believes that design should be rational.



## YONOH

**Yonoh** es un estudio creativo formado por **Clara del Portillo** y **Alex Selma**. El estudio se caracteriza por sus diseños sencillos a la par que funcionales, en los que cada detalle está planificado minuciosamente. Su trabajo ha sido reconocido con premios tan prestigiosos como **Red Dot**, **IF design award** o **Wallpaper\***, entre otros. Pueden presumir de sus bellos diseños en el campo de la iluminación para **Fambuena**, **Marsset** o **Lzf-lamps**, así como **Porcelanosa**. Tras los sillones y sofás **Sumo** y nuestro particular **Mosaico**, el estudio nos presenta **Mullit**.



**Yonoh** is a creative studio set up by **Clara del Portillo** and **Alex Selma** in 2006. The studio is characterized by its simple, yet functional designs, studying each small detail minutely in each of their projects. During their career **Yonoh** has been awarded with the most prestigious design prizes worldwide as **Red Dot**, **IF design award** or **Wallpaper\*** Design Award, among others. They can feel proud of the beautiful lamps for **Fambuena**, **Marsset** or **Lzf-lamps**. They have also worked with international firms like **Porcelanosa**, amongst others. After the success of the **Sumo** chairs and sofas and the particular **Mosaico** puzzle, they present **Mullit** chair.

## NOTE

**Note** tiene sede en Estocolmo. El estudio, fundado en 2008 por un equipo multidisciplinar, realiza proyectos de interiorismo, producto y gráfica. Como diseñadores de producto, sus trabajos para **Le Chance**, **Menu**, **Zero** o **Punt** entre otras destacadas marcas han tenido amplia repercusión. **La Isla** es su segunda colaboración con , tras de la exitosa familia de asientos **Tonella**.

Se presentan a sí mismos del siguiente modo: "Notar algo y hacerse notar: nuestro nombre nombra aquello que perseguimos. Nos gusta prestar atención a aquello que nos rodea y tratar de crear piezas que hagan a los demás sentir lo mismo. Buscando aquello que es único en cada proyecto y enfatizándolo, conseguimos transformar valores y sensaciones en objetos y espacios táctiles".

**Note** is a Stockholm-based design studio founded in 2008 working within the fields of architecture; interior; product and graphic design as well as design strategy. Their pieces for **Le Chance**, **Menu**, **Zero** or **Punt** among other brands have become renowned worldwide. **La Isla** is their second design for **Sancal**, after the great success of the **Tonella** family.

Their philosophy is to stand out from the crowd: "To note something, to get noticed: we are named after what we try to achieve. We like to pay attention to our surroundings, and try to create things that make others do the same. By looking at what is unique in every project and emphasizing that, we transform non-material values into tactile objects and spaces."



## SANTIAGO CASTAÑO

Santiago fundó **Sancal** en 1973. Diseñador autodidacta e incombustible emprendedor, comenzó su andadura profesional como tapicero. Este conocimiento profundo de la profesión le ha servido a lo largo de toda su vida para colaborar con numerosos diseñadores, pero también, para diseñar algunos de los productos más atemporales de la empresa.

Según **Esther** y **Elena**, *“la historia de Sancal no estaría completa sin tener en cuenta la labor realizada por Santiago en el ámbito del diseño”*.

**Santiago Castaño** founded **Sancal** in 1973. A self-taught and energetic entrepreneur, he began his professional career as an upholsterer. This deep knowledge of the profession has served him well throughout his life when collaborating with numerous designers, and designing some of **Sancal**'s most well-known and popular designs.

In **Esther**'s and **Elena**'s words, *“Sancal's history wouldn't be complete without considering Santiago's contribution to its design”*.

## ISAAC PIÑEIRO

Siguiendo la filosofía del estudio **NADADORA**, del que formó parte durante más de 10 años junto con **Cristina Alonso**, para **Isaac** prima la honestidad conceptual y la sencillez; comunicar a primera vista para desarrollar proyectos cercanos. Ha colaborado con empresas como **Lavandera**, **Sagen Ceramics**, **La Murrina**, **Nutella** o **Serralunga**. La amistad con **Sancal** viene de lejos. Fruto de esta relación celebramos productos tan aclamados y variopintos como los pufs **Elephant**, las **Sillas40** o la cúpula acústica **Tartana**, así como la familia **Tortuga**.



**Isaac** preserves the essence of **NADADORA**, the design studio that he founded along with **Cristina Alonso** 10 years ago. His conceptually honest, straightforward philosophy is evident in each and every piece. He has worked with brands like **Lavandera**, **Sagen Ceramics**, **La Murrina**, **Nutella** and **Serralunga**. His friendship with **Sancal** goes back years. Some of our most acclaimed products have sprung from their pens, including the **Elephant** poufs, the **Silla40**, the **Tartana** acoustic hood and the **Tortuga** product range.



## ESTUDIO SANCAL

El **Estudio Sancal** nació con la finalidad de dar soporte técnico a los diseñadores freelance con los que **Santiago Castaño** comenzó a trabajar a mediados de los años '80.

**Esther** y **Elena** han convertido este pequeño atelier en el corazón creativo de la empresa. Con las dosis justas de tesón y locura, lideran un talentoso equipo multidisciplinar para desarrollar los más variopintos proyectos; desde una campaña de publicidad a la escenografía de toda una colección o productos tan singulares como los **Perigallo**.

**Estudio Sancal** was born with the purpose of giving technical support to the freelance designers with whom **Santiago Castaño** began working in the mid-1980s.

**Esther** and **Elena** have turned this small atelier into the creative heart of the company. With the right doses of determination and madness, they lead a talented multidisciplinary team to develop the most varied of projects; from an advertising campaign to the scenography of a whole collection of products, some as unique as the **Perigallo**.



# Mousse

## By RAFA GARCÍA

### *Placer multisensorial.*

**Rafa García** se ha colgado el mandil de repostero para ofrecernos una de sus recetas más dulces, **Mousse**, un amplio programa modular de asientos para el placer de los sentidos.

Purista en sus formas y de equilibradas proporciones, a la vista queda patente su dulce carácter gracias a sus suaves volúmenes, marcando un cariz atemporal más allá de modas efímeras.

Su sentada, de esponjoso y mullido tacto, es su rasgo distintivo pues emula esa textura de diminutas burbujas tan característica del popular postre. Además, al igual que él aparenta un compacto bloque que se desvanece tan pronto lo pruebas.

**Mousse** es una invitación a dejarse llevar, transformando la acción de sentarse en toda una experiencia. Sus almohadas accesorias ayudan a potenciar esta sensación.

Otro aspecto que lo hace singular es la gran modularidad disponible. Las 2 tipologías de módulos y chaises sumadas a las dos alturas de brazos, los numerosos pufs y los distintos terminales, dan como resultado una infinidad de posibilidades que permiten configurar composiciones lineales o angulares casi únicas, adaptándose a las necesidades de cada espacio.

Los detalles, discretos y sigilosos suman identidad. Las patas suscriben la simplicidad formal del modelo, mientras que el hecho de poder lacarlas en cualquier color de nuestro muestrario aporta un extra de personalización. **Mousse** introduce también una mesita auxiliar y 3 tamaños de bandeja con 2 alturas distintas, que permiten ser colocados sobre cualquier elemento (brazo, respaldo o asiento). Un nuevo acabado

denominado “craquelé” va a convertir en centro de atención las tapas de estos accesorios.

En cuanto a los tejidos disponibles, la oferta es casi infinita. Sin embargo, para su lanzamiento hemos realizado una cuidada y exclusiva selección entre los que destacan los muestrarios 121, 122 y 123, cuyos falsos lisos aportan movimiento y carácter al producto.

Una vez más, **Rafa** ha dado con la fórmula para elaborar una delicada propuesta y sorprender con gusto a los paladares de los más exigentes gourmets.

### *A pleasure for all five senses.*

**Rafa García** has put on his apron to offer us one of his sweetest recipes, **Mousse**, a wide ranging seating system to the delight of all of the senses.

Purist in its forms and balanced proportions, the sweet character is expressed through supple visual cues. A timeless look beyond ephemeral fashions.

The seat, fluffy and soft, emulates the texture of air bubbles so characteristic of the popular dessert. **Mousse** is an invitation to let go and be caught, transforming the action of sitting into an experience. The snug fibre and foam interior cocoons us and absorbs the din of contemporary living, much to the relief of our ears. The scatter cushions help to enhance this feeling.

Another aspect that makes the **Mousse** unique is the varied array of modular elements available. Two types of modules and chaises with two arm heights, along with different

poufs and terminals, offer unlimited possibilities to configure linear or angular compositions. This, coupled with an extensive selection of fabrics, means that the **Mousse** can fit into a wide range of interiors.

The accessories and details add identity to this model. The **Mousse** includes an auxiliary table with three tray sizes and two different heights, which can be placed on any element (arm, back or seat). A new finish called “craquelé” helps to set these pieces apart. The innovative foot design can be lacquered in any colour, providing extra personalization.

The choice of upholstery fabrics is almost endless. However, for its launch we have made a careful and exclusive selection, highlighting the vibrant samples books 121, 122 and 123, false plains that provide the product with a sense of movement and character.

Once again, **Rafa** has found the formula to cook up a delicate creation for the most demanding palates.



















12

13

14

15

E

B

A









**MOUSSE** by Rafa García





18

8

19



**MOUSSE** by Rafa Garcia

20

21

22







**MOUSSE** by Rafa Garcia



















**MOUSSE** by Rafa García



# Db

## By SANTIAGO CASTAÑO

*¡Una joya por descubrir!*

**DB** es el acrónimo de “diamante en bruto”, apelativo con el que Elena y Esther Castaño han bromeado durante años cada vez que se acomodaban en un viejo prototipo diseñado por su padre. Cada verano, el enorme y confortable sillón las envolvía en tardes de lectura o de siesta y siempre decían: *“¡no entendemos porque no salió al mercado! Con algunos pequeños retoques encajaría perfectamente en el catálogo de Sanca! Es un diamante en bruto que está por pulir...”*

Dicho y hecho. Tras un ligero reestiling y una actualización de materiales, **DB** está listo para que cualquiera pueda disfrutar de él.

Sus diagonales y ángulos facetados, aplicados incluso a las patas, nos recuerdan a la codiciada piedra. Por otra parte, su aspecto es rotundo, así que el apellido “bruto” le viene al pelo. Ahora te toca a ti decidir si quieres sacarle brillo.

*A jewel to be discovered!*

**DB** is the Spanish acronym for “Diamante en Bruto” (rough diamond). Elena and Esther Castaño have joked about this nickname for years, every time they settled into an old prototype designed by her father. Every summer, the huge, comfortable armchair wrapped around them while reading or taking a nap. They always said: *“We don’t understand why it wasn’t presented in society! With some small tweaks, it would fit perfectly into Sanca’s catalogue. It’s a rough diamond to be polished ...”*

So, after a slight re-styling and upgrade, **DB** is ready to be enjoyed by anyone.

Its diagonal and faceted angles, even applied to the legs, remind us of the precious stone. On the other hand, its stern lines lend themselves to the product’s “rough” surname. Now it’s your turn to decide if you want to polish it.



34





33







35







16



36



30







38

26

35

39





# Mullit

## By YONOH

### *Un cojín con patas.*

¿A quién no le gusta acurrucarse en un mullido y confortable cojín? ¿Por qué no trasladar esta agradable sensación a una silla?

Partiendo de la alocada idea de “cojín con patas”, **Yonoh** se puso manos a la obra. El resultado es **Mullit**, una silla en la que la originalidad de su diseño y la sencillez de sus formas es más que evidente.

El equilibrio de sus proporciones viene marcado por los contundentes volúmenes de almohadas de asiento y respaldo, así como por la ligereza visual que aportan sus patas, invitando a tomar asiento y disfrutar de una placentera experiencia.

Para reforzar el efecto mullido, hemos recurrido a un sutil fruncido textil e incorporado un vivo en el borde de las almohadas, imitando aún más si cabe la forma de un cojín.

La versatilidad de esta pieza se halla en la amplia oferta textil y en la singularidad de cada una de las bases disponibles: unas patas de madera despuntadas cual palillos, unas patas de varilla de metal con reminiscencias de otro tiempo bañadas en oro y otras de tubo de metal negro reducidas a la mínima expresión.

*“En **Mullit** queríamos conseguir una silla que combinara estética y confort. De algún modo, queríamos trasladar la sensación de comodidad que tenemos al sentarnos sobre un cojín a un asiento, sin perder de vista las necesidades ergonómicas. Un juego de volúmenes y pesos visuales que se trasladan a un producto muy funcional a la vez”.*

### *A cushion with legs.*

Do you love snuggling a soft and soothing cushion? How about feeling the same in a chair?

This crazy idea of a “cushion with legs” was the starting point for **Yonoh** to roll up their sleeves and get down to work. The result is **Mullit**, an original chair with a formal design.

Its proportions are well balanced thanks to the overwhelming volumes of seat and back cushions set against the visual lightness provided by its legs, inviting you to take a seat and enjoy a pleasant experience.

To reinforce the fluffy effect, a subtle ruffle has been used on its back, as well as a piping; another nod to scatter cushions.

The wide range of textiles and a choice of bases contribute to the versatility of the chair: wooden legs that look like toothpicks, minimalist metal legs or electrolytic plating from a past epoch.

*“At **Mullit** we wanted to get a chair that combined aesthetics and comfort. Somehow, we wanted to transfer the feeling of comfort we have when sitting on a cushion to a chair without losing ergonomic needs. Volumes and weights plays a visual effect in a very functional product”.*



40





41



40





42



43









MULLIT by Yonoh



# Tonella

## By NOTE

### *De tal palo tal astilla.*

Desde **Sancal** no podíamos resistirnos a aumentar la coqueta familia **Tonella** con un nuevo miembro. En esta ocasión, el estudio sueco **Note** nos presenta el taburete, la versión más esbelta y ligera de la estirpe.

Las duelas de un tonel siguen siendo el elemento inspirador, si bien, en esta ocasión, **Note** ha llevado al límite este elemento común, pues las varillas metálicas adquieren en el taburete mucho más protagonismo que en sus predecesores.

La almohada de asiento, tapizada en tela o piel, adopta una recatada presencia y dota de una estética liviana, casi etérea, a la totalidad del conjunto.

La base está disponible en dos alturas y dos acabados metalizados: bronce y nácar.

Con este nuevo miembro en la familia seguimos rindiendo homenaje a nuestros orígenes.

### *Like mother, like daughter!*

We could not resist the temptation to add a new member to the coquettish **Tonella** family. On this occasion, the Swedish design studio **Note** presents the stool, the most slender product in the line.

Spanish wine barrel staves are the inspiring element as they have been with the other products in the range, although, on this occasion, **Note** has taken this design accent to the limit. The metal rods acquire much more prominence in the stool than in their predecessors.

The seat cushion, upholstered in fabric or leather, adopts a demure presence and gives an ethereal aesthetic to the whole piece.

The metal support is available in two heights and two finishes: bronze or nacar.

With this new member in the family we continue paying tribute to our origin in wine growing southern Spain.



47











50

47







51

52





# Nido

## By Rafa García

*A cada pajarillo parécele bien su nido.*

**Rafa García** ha ampliado la progenie de **Nido** con una silla tan ligera y sencilla como su predecesora. Al igual que la butaca, el nido que sirve de refugio y protección para un gran número de especies ha sido el elemento inspirador.

Su suave sentada está sustentada por una base de madera de fresno que es el resultado de un artesanal trabajo de carpintería. Como si de las ramas de árbol se tratara, la parte superior de las patas abraza y rodea el asiento.

Las reducidas medidas hacen de esta pieza una alternativa excelente para acompañar mesas de comedor o, por qué no, en oficinas, como silla confidente, donde los límites del espacio son clave para la creación de ambientes.

Esta versatilidad también reside en las 3 alternativas para las patas: dos opciones en madera de fresno, disponibles en todos los colores de nuestra carta de tintes y una variante de varilla de metal con acabado epoxi negro.

El tapizado está disponible en dos versiones, una más tensa y otra acolchada. Su estilizado perímetro está remarcado por un vivo siempre de color negro que facilita las composiciones bi-color. Su tapizado es fijo tanto en tela como en piel.

La familia de butacas y sillas **Nido** son, pues, un cálido y acogedor refugio.

*A nest for each little bird.*

**Rafa García** has added a dining chair to the **Nido** product family with a design that is as simple as its predecessor. Just like the original lounge chair, a nest, serving as a refuge and protection for a large number of species has been the inspiration.

The seat or "nest" is supported by a hand-crafted ash wood frame or metal feet in a black-matte finish. The upper part provides "branches" into which the comfortable seat is fixed.

Its small size turns this piece into an excellent alternative for dining tables or a side chair for any workspace, where the space limits are the key for building an environment.

The chair's versatility can be found in the feet options: two ash wood types (available in 19 different colours) or a metal version in a black epoxy finish.

The upholstery is available in two versions: tightly tailored or quilted. The chair's contour is highlighted by black piping, ideal for creating a two tone effect.

The **Nido** family of chairs is a warm and cozy refuge for everyone.



55





55



56







57



58









**NIDO** by Rafa García







**NIDO** by Rafa García



# Dumbbell

## By Estudio Sancal

### *Un ejercicio de fuerza.*

**Dumbbell** es un término de origen anglosajón que hace referencia a las pesas empleadas para desarrollar la musculatura de brazos y hombros.

**Estudio Sancal** ha realizado un “forzado” ejercicio de simplificación hasta llegar a **Dumbbell**, una amplia colección de mesas inspiradas en la simetría y robustez de las mancuernas.

Su acabado monocolor en blanco, negro, gris o teja refuerza el carácter macizo de las mesas, aligerado sólo por el perfil en tono natural de la tapa.

Para su construcción se han seleccionado materiales sólidos y resistentes como el tablero marino y el laminado de alta presión tanto en las tapas como en las bases, mientras que el pie central es de acero lacado.

La extensa variedad de opciones disponibles se debe a la combinación de las diferentes medidas y formas de sus sobres – redondos o cuadrados -, así como por las cinco alturas proyectadas y los 4 colores seleccionados para todas ellas.

La resistencia de **Dumbbell** hace que esta familia de mesas sea apta para todo tipo de espacios, domésticos y colectivos.

### *An exercise in design.*

**Dumbbell** by **Estudio Sancal** is a “strong” exercise in design; a wide collection of tables inspired by the symmetry and power of dumbbells weights.

White, black, grey or rust colour finishes reinforce the solid look of the tables, and provide a contrast for the top's edge.

A selection of solid, resistant materials have been used for its construction, such as marine board, used in tops and bases and a lacquered steel foot.

The product is available in a wide variety of options, boasting four colours, a round or square top and five different heights.

**Dumbbell**'s resistance makes this family of tables highly suitable for a variety of residential or commercial projects.



61















# Tortuga

## By Isaac Piñeiro

### *Adaptación al medio.*

De la inquietud de **Isaac Piñeiro** por dar un paso más en la evolución de **Tortuga**, surge la idea de crear una familia de mesas de comedor utilizando el mismo sistema de construcción empleado en las patas de las butacas y las mesitas auxiliares.

Se trata de un diseño de líneas muy limpias, atemporal y elegante, en el que la madera de fresno toma protagonismo a través de su vetada consistencia; y la sutil estructura de metal perfila las líneas con su rotundo color negro.

Los sobres de las mesas pueden ser redondos, con tres patas que se unen en el centro, o bien rectangulares con una pata en cada esquina. Existen dos medidas para cada opción.

Gracias a las nuevas incorporaciones, la familia **Tortuga** se adapta mejor a todo tipo de ecosistemas. Sillones, butacas, pufs y mesitas completan la oferta en lo que promete ser un longevo recorrido por **Sanca**l.

### *Continues to evolve.*

**Isaac Piñeiro** continues to evolve the timeless **Tortuga** product range by adding a dining table. The design language used in the armchairs and auxiliary tables is clearly visible, with a familiar leg construction running through the collection ...

The product's clean lines focus attention on the ash wood's beautiful natural grain. The black metal structure, used throughout the range, acts as a design accent, outlining the shape of the feet.

Choose between round table-tops, with three legs that are joined in the center, or rectangular with a leg in each corner. There are two sizes for each option.

And so, with these new additions, the **Tortuga** family adapts even better to all types of ecosystem. They join the full-sized and mini lounge chairs, poufs and auxiliary tables for what promises to be a long journey through Sancal's story.



67





46









**TORTUGA** by Isaac Píñero



# La Isla

## By NOTE

### *Un archipiélago lleno de vida.*

En nuestra travesía por los océanos avistamos un conjunto de pequeños islotes, que completan el extenso archipiélago de **La Isla**. Las nuevas mesitas auxiliares amplían la oferta de la colección de bancos para colectividades concebida por el estudio sueco **Note**.

Al igual que en los asientos, las líneas curvas destacan en estas mesas. Sus 3 alturas y la forma de sus sobres, redondo u ovalado, hacen que puedan interactuar entre ellas. Las bases, con forma de aspa, recuerdan formalmente al respaldo de los bancos, sin duda el elemento distintivo común a toda la familia. Los sobres son de cristal fumé por lo que dejan entrever la tan característica base, la cual puede ser lacada en todas las opciones de laca de nuestra carta.

**La Isla** ha sido concebida como un punto de reunión para crear zonas de tránsito en las que el diseño sirva de acogedor refugio para navegantes...

### *A lively archipelago.*

During our last voyage we discovered a group of small islets – occasional tables – which complete the acclaimed **La Isla** archipelago by the Swedish Studio **Note**.

The curved lines provide a common design language that runs through La Isla's upholstery and tables. Three heights are available and the tabletops can be round or oval. The bases, shaped like a blade, are a nod to the shape of the benches' backs. The fumé glass tops enables us to take a closer look at the distinctive base, which can be lacquered as per our colour chart.

**La Isla** have been conceived as a meeting point for transit areas in which the design acts as an enticing destination in a sea of nothingness...



30



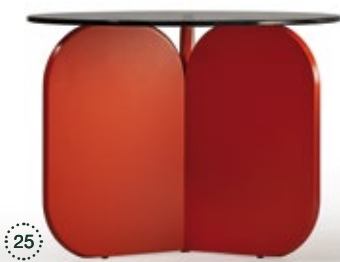
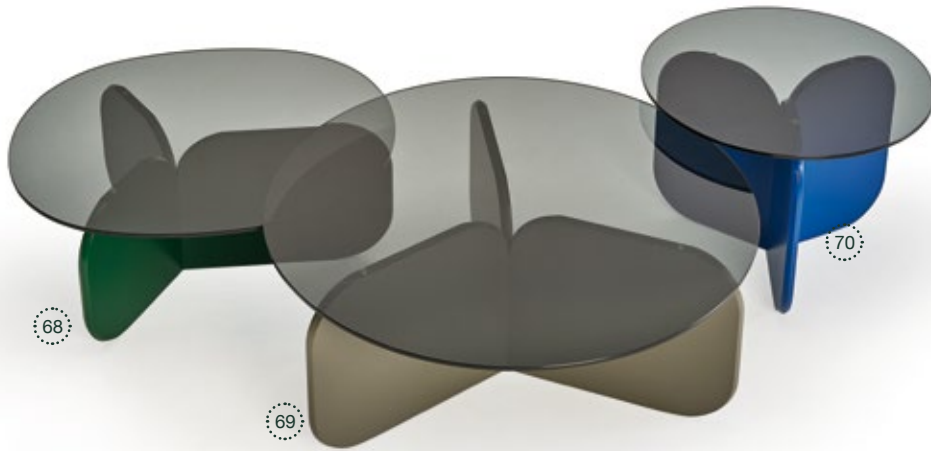















32

30

22



# Technical index

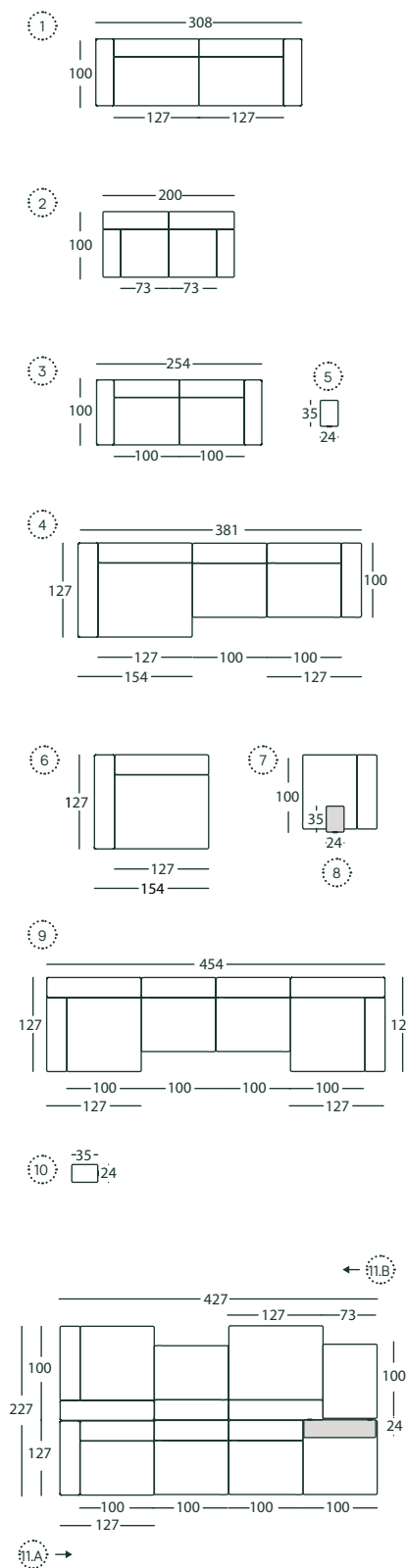

ID	UNL. QTY	MOD.	REF.	DESCRIPCIÓN / DESCRIPTION	ACABADO FINISHES	TELAS / MATERIAL	SERIES	MUESTRARIO SAMPLE BK.
1	1	MOUSSE	317.11.Z7.BB2	SOFA 308 BRAZO 100 BAJO SOFA 308 LOW ARM 100	001-NEGRO BLACK	7203	7	124
2	1	MOUSSE	317.11.W.BB1	SOFA 200 BRAZO 73 BAJO SOFA 200 LOW ARM 73	001-NEGRO BLACK	801 SIENA	12	CLASSIC 2
3	1	MOUSSE	317.11.Z2.BB2	SOFA 254 BRAZO 100 BAJO SOFA 254 LOW ARM 100	125-BERENJENA AUBERGINE	6225	6	121
4	1	MOUSSE	317.14.NN	CHAISE 127X127	001-NEGRO BLACK	6216	6	121
1			317.13.BA3.I	BRAZO 127 ALTO IZDO HIGH ARM 127 LEFT	001-NEGRO BLACK	6216	6	121
1			317.12.L	MOD 100	001-NEGRO BLACK	6216	6	121
1			317.12.L	MOD 100	001-NEGRO BLACK	6216	6	121
1			317.13.BA2.D	BRAZO 100 ALTO DCHO HIGH ARM 100 RIGHT	001-NEGRO BLACK	6216	6	121
5	1	MOUSSE	317.71.CDE	MESA AUXILIAR 24X35X47 OCCASIONAL TABLE 24X35X47	135-C. AMARILLO C. YELLOW / 001-NEGRO BLACK	-	-	-
6	1	MOUSSE	317.14.NN	CHAISE 127X127	001-NEGRO BLACK	6216	6	121
1			317.13.BA3.I	BRAZO 127 ALTO IZDO HIGH ARM 127 LEFT	001-NEGRO BLACK	6216	6	121
7	1	MOUSSE	317.12.L	MOD 100	001-NEGRO BLACK	6216	6	121
8	1	MOUSSE	317.71.CDE	MESA AUXILIAR 24X35X47 OCCASIONAL TABLE 24X35X47	132 C. VERDE C. GREEN / 001-NEGRO BLACK	-	-	-
9	1	MOUSSE	317.14.NN.I	CHAISE 127X127 IZDO CHAISE 127X127 LEFT	001-NEGRO BLACK	6216	6	121
1			317.13.BA2.I	BRAZO 100 ALTO IZDO HIGH ARM 100 LEFT	001-NEGRO BLACK	6216	6	121
2			317.12.L	MOD 100	001-NEGRO BLACK	6216	6	121
1			317.14.NN.D	CHAISE 127X127 DCHO CHAISE 127X127 RIGHT	001-NEGRO BLACK	6216	6	121
1			317.13.BB2.D	BRAZO 100 BAJO DCHO LOW ARM 100 RIGHT	001-NEGRO BLACK	6216	6	121
10	1	MOUSSE	317.71.CDE	MESA AUXILIAR 24X35X47 OCCASIONAL TABLE 24X35X47	134 C. BLANCO C. WHITE / 001-NEGRO BLACK	-	-	-
11.A	1	MOUSSE	317.12.L	MOD 100	001-NEGRO BLACK	6216	6	121
1			317.13.BB2.I	BRAZO 100 BAJO IZDO LOW ARM 100 LEFT	001-NEGRO BLACK	6216	6	121
2			317.12.L	MOD 100	001-NEGRO BLACK	6216	6	121
1			317.15.LL	PUF 100X100 POUF 100X100	001-NEGRO BLACK	6216	6	121
1			317.79.KCE	MESA BANDEJA 97X24X47 SHELF 97X24X47	043-MANGO / 001-NEGRO BLACK	-	-	-
11.B	1	MOUSSE	317.15.LH	PUF 100X73 POUF 100X73	001-NEGRO BLACK	822 CEMENTO	12	CLASSIC 2
1			317.14.NN	CHAISE 127X127	001-NEGRO BLACK	6216	6	121
1			317.12.L	MOD 100	001-NEGRO BLACK	6216	6	121
1			317.14.NN.D	CHAISE 127X127 DCHO CHAISE 127X127 RIGHT	001-NEGRO BLACK	6216	6	121
1			317.13.BB2.D	BRAZO 100 BAJO DCHO LOW ARM 100 RIGHT	001-NEGRO BLACK	6216	6	121

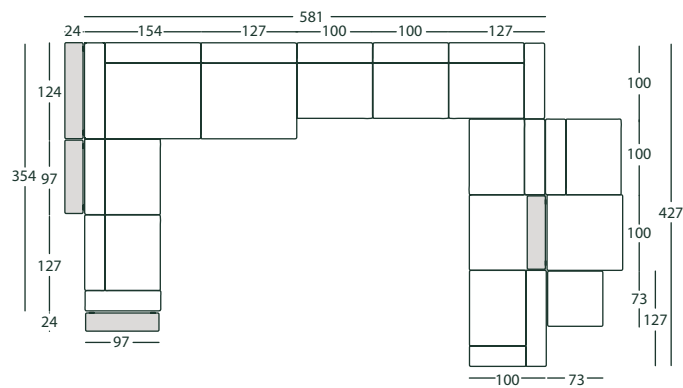

ID	UNI. QTY.	MOD.	REF.	DESCRIPCIÓN / DESCRIPTION	ACABADO FINISHES	TELAS / MATERIAL	SERIES	MUESTRARIO SAMPLE BK.
12	1	MOUSSE	317.12.L	MOD 100	001-NEGRO BLACK	6216	6	121
1			317.13.BB2.I	BRAZO 100 BAJO IZDO LOW ARM 100 LEFT	001-NEGRO BLACK	6216	6	121
1			317.79.KCE	MESA BANDEJA 97X24X47 SHELF 97X24X47	134 C.BLANCO C. WHITE/ 001-NEGRO BLACK	-	-	-
1			317.12.L	MOD 100	001-NEGRO BLACK	6216	6	121
1			317.79.KCG	MESA BANDEJA 97X24X62 SHELF 97X24X62	004-CENIZA ASH GREY / 001-NEGRO BLACK	-	-	-
1			317.14.NN	CHAISE 127X127	001-NEGRO BLACK	6216	6	121
1			317.13.BA3.I	BRAZO 127 ALTO IZDO HIGH ARM 127 LEFT	001-NEGRO BLACK	6216	6	121
1			317.79.NCG	MESA BANDEJA 124X24X62 SHELF 124X24X62	004-CENIZA ASH GREY / 001-NEGRO BLACK	-	-	-
1			317.14.NN	CHAISE 127X127	001-NEGRO BLACK	6216	6	121
2			317.12.L	MOD 100	001-NEGRO BLACK	6216	6	121
1			317.12.L	MOD 100	001-NEGRO BLACK	6216	6	121
1			317.13.BA2.D	BRAZO 100 ALTO DCHO HIGH ARM 100 RIGHT	001-NEGRO BLACK	6216	6	121
1			317.12.L	MOD 100	001-NEGRO BLACK	6216	6	121
1			317.15.LL	PUF 100X100 POUF 100X100	001-NEGRO BLACK	6216	6	121
1			317.79.KCE	MESA BANDEJA 97X24X47 SHELF 97X24X47	043-MANGO / 001-NEGRO BLACK	-	-	-
1			317.12.N.D	MOD 127 DCHO MOD 127 RIGHT	001-NEGRO BLACK	6216	6	121
1			317.13.BB1.D	BRAZO 73 BAJO DCHO LOW ARM 73 RIGHT	001-NEGRO BLACK	6216	6	121
1			317.15.HH	PUF 73X73 POUF 73X73	001-NEGRO BLACK	822 CEMENTO	12	CLASSIC 2
1			317.15.LL	PUF 100X100 POUF 100X100	001-NEGRO BLACK	822 CEMENTO	12	CLASSIC 2
1			317.12.L	MOD 100	001-NEGRO BLACK	822 CEMENTO	12	CLASSIC 2



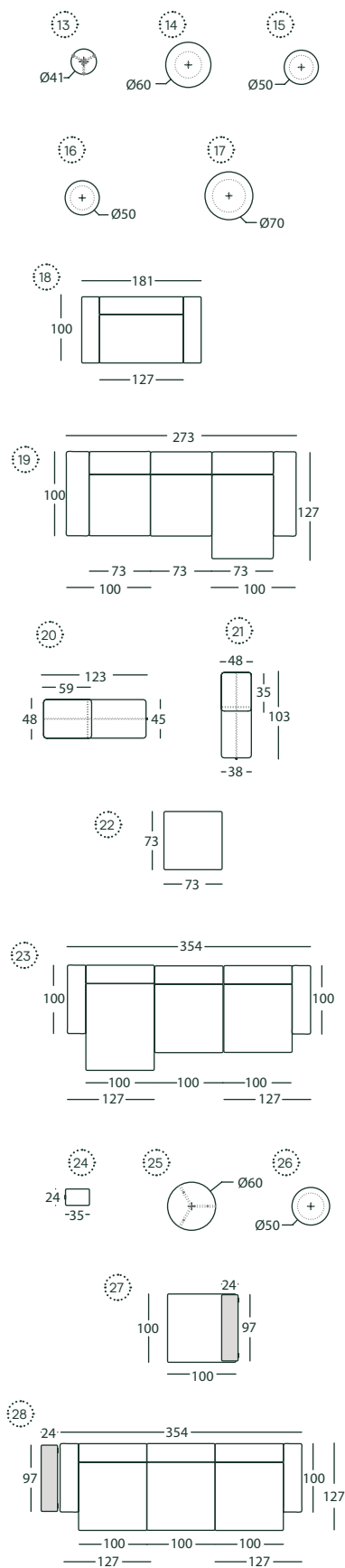

ID	UNI. QTY.	MOD.	REF.	DESCRIPCIÓN / DESCRIPTION	ACABADO FINISHES	TELAS / MATERIAL	SERIES	MUESTRARIO SAMPLE BK.
13	1	TORTUGA	305.71	MESA D41X45 TABLE D41X45	053 TEJA BRIK-RED	-	-	-
14	1	DUMBBELL	318.71.D60X40	MESITA D60X40 OCCASIONAL TABLE D60X40	127-BRIQUE	-	-	-
15	1	DUMBBELL	318.71.D50X50	MESITA D50X50 OCCASIONAL TABLE D50X50	127-BRIQUE	-	-	-
16	1	DUMBBELL	318.71.D50X50	MESITA D50X50 OCCASIONAL TABLE D50X50	128-MEGEVE	-	-	-
17	1	DUMBBELL	318.71.D70X40	MESITA D70X40 OCCASIONAL TABLE D70X40	126-CENDRE	-	-	-
18	1	MOUSSE	317.11.U.BA2	SOFA 181 BRAZO 100 ALTO SOFA 181 HIGH ARM 100	125-BERENJENA AUBERGINE	6226	6	121
19	1	MOUSSE	317.12.H	MOUSSE MOD 73	123 ULTRAMAR	6204	6	120
1			317.13.BA2.I	BRAZO 100 ALTO IZDO HIGH ARM 100 LEFT	123 ULTRAMAR	6204	6	120
1			317.12.H	MOD 73	123 ULTRAMAR	6204	6	120
1			317.14.HN	CHAISE 73X127	123 ULTRAMAR	6204	6	120
1			317.13.BA2.D	BRAZO 100 ALTO DCHO HIGH ARM 100 RIGHT	123 ULTRAMAR	6204	6	120
20	1	DUPLEX	309.71.NED	MESA 123X48X30 TABLE 123X48X30	052-KLEIN BLUE / 001-NEGRO BLACK	-	-	-
1			309.32.FE	BANDEJA 59X48 TRAY 59X48	132-C. VERDE C.GREEN	-	-	-
21	1	DUPLEX	309.71.LDE	MESA 103X38X41 TABLE 103X38X41	052-KLEIN BLUE / 001-NEGRO BLACK	-	-	-
1			309.32.DC	BANDEJA 26X38 TRAY 26X38	132-C.VERDE C.GREEN	-	-	-
22	1	MOUSSE	317.15.HH	PUF 73X73 POUF 73X73	123 ULTRAMAR	6204	6	120
23	1	MOUSSE	317.14.LR	CHAISE 100X154	125-BERENJENA AUBERGINE	6225	6	121
1			317.13.BB2.I	BRAZO 100 BAJO IZDO LOW ARM 100 LEFT	125-BERENJENA AUBERGINE	6225	6	121
1			317.12.L	MOD 100	125-BERENJENA AUBERGINE	6225	6	121
1			317.12.L	MOD 100	125-BERENJENA AUBERGINE	6225	6	121
1			317.13.BB2.D	BRAZO 100 BAJO DCHO LOW ARM 100 RIGHT	125-BERENJENA AUBERGINE	6225	6	121
24	1	MOUSSE	317.71.CDE	MESA AUXILIAR 24X35X47 OCCASIONAL TABLE 24X34X47	003-NOGAL WALNUT / 125- BERENJENA AUBERGINE	-	-	-
25	1	LA ISLA	314.71.D60X45	MESITA D60X45 OCCASIONAL TABLE D60X45	113-MANGO	-	-	-
26	1	DUMBBELL	318.71.D50X50	MESITA D50X50 OCCASIONAL TABLE D50X50	001-NOIR	-	-	-
27	1	MOUSSE	317.15.LL	PUF 100X100 POUF 100X100	125-BERENJENA AUBERGINE	6225	6	121
1			317.79.KCE	MESA BANDEJA 97X24X47 SHELF 97X24X47	043-MANGO / 125-BERENJENA AUBERGINE	-	-	-
28	1	MOUSSE	317.14.LN	CHAISE 100X127	121 LIMÓN LEMON	5005	5	122
1			317.13.BA2.I	BRAZO 100 ALTO IZDO HIGH ARM 100 LEFT	121 LIMÓN LEMON	5005	5	122
1			317.79.KCG	MESA BANDEJA 97X24X62 SHELF 97X24X62	135-C. AMARILLO C. YELLOW / 121 LIMÓN LEMON	-	-	-
1			317.14.LN	CHAISE 100X127	121 LIMÓN LEMON	5005	5	122
1			317.14.LN	CHAISE 100X127	121 LIMÓN LEMON	5005	5	122
1			317.13.BA2.D	BRAZO 100 ALTO DCHO HIGH ARM 100 RIGHT	121 LIMÓN LEMON	5005	5	122

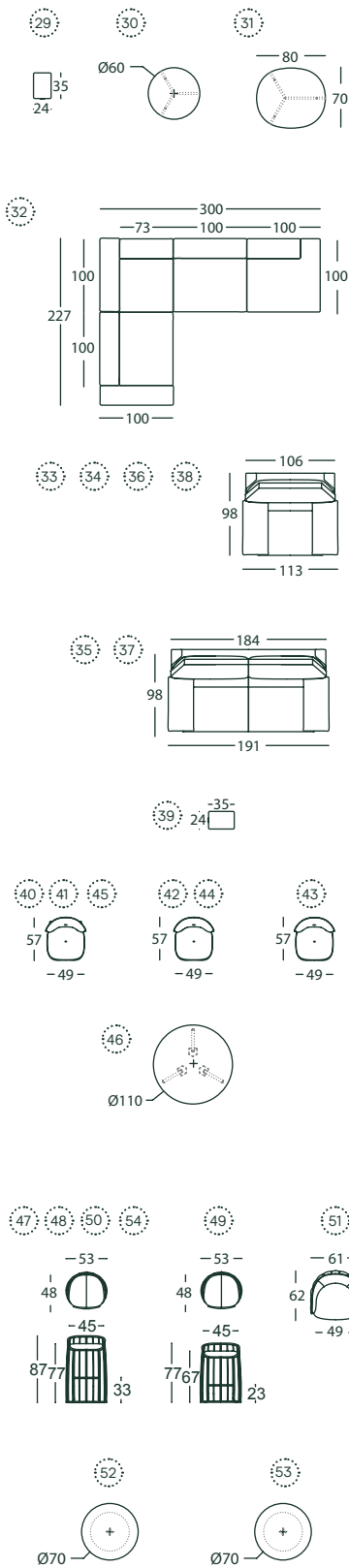

ID	UNI. QTY.	MOD.	REF.	DESCRIPCIÓN / DESCRIPTION	ACABADO FINISHES	TELAS / MATERIAL	SERIES	MUESTRARIO SAMPLE BK.
29	1	MOUSSE	317.71.CDE	MESA AUXILIAR 24X35X47 OCCASIONAL TABLE 24X35X47	135-C. AMARILLO C. YELLOW / 121 LIMÓN LEMON	-	-	-
30	1	LA ISLA	314.71.D60X45	MESITA D60X45 OCCASIONAL TABLE D60X45	121 LIMÓN LEMON	-	-	-
31	1	LA ISLA	314.71.80X70X35	MESITA 80X70X35 OCCASIONAL TABLE 80X70X35	093- CUARZO QUARTZ GREY	-	-	-
32	1	MOUSSE	317.12.L	MOD 100	125-BERENJENA AUBERGINE	6225	6	121
	1		317.13.BB.2.I	BRAZO 100 BAJO IZDO LOW ARM 100 LEFT	125-BERENJENA AUBERGINE	6225	6	121
	1		317.12.L.D	MOD 100 DCHO MOD 100 RIGHT	125-BERENJENA AUBERGINE	6225	6	121
	1		317.13.BA.1.D	BRAZO 73 ALTO DCHO HIGH ARM 73 RIGHT	125-BERENJENA AUBERGINE	6225	6	121
	1		317.12.L	MOD 100	125-BERENJENA AUBERGINE	6225	6	121
	1		317.17.LL.D	MOD TERMINAL 100 DCHO RIGHT TERMINAL MODULE 100	125-BERENJENA AUBERGINE	6225	6	121
33	1	DB	319.11.M	SILLON 113 ARMCHAIR 113	052-KLEIN BLUE	6176	6	119
34	1	DB	319.11.M	SILLON 113 ARMCHAIR 113	042-YELLOW	5004	5	122
35	1	DB	319.11.V	SOFA 191	006-ANTRAC	6226	6	121
36	1	DB	319.11.M	SILLON 113 ARMCHAIR 113	003 NOGAL WALNUT	810 BAOBAB	12	CLASSIC 2
37	1	DB	319.11.V	SOFA 191	052-KLEIN BLUE	5003	5	122
38	1	DB	319.11.M	SILLON 113 ARMCHAIR 113	052-KLEIN BLUE	6232	6	123
39	1	MOUSSE	317.71.CDE	MESA AUXILIAR 24X35X47 OCCASIONAL TABLE 24X35X47	135-C. AMARILLO C. YELLOW / 125-BERENJENA AUBERGINE	-	-	-
40	1	MULLIT	320.41	SILLA ESTRUCTURA METAL METAL STRUCTURE CHAIR	088-ORO GOLD	GALAX108	7	GALAXY KVADRAT
41	1	MULLIT	320.41	SILLA ESTRUCTURA METAL METAL STRUCTURE CHAIR	088-ORO GOLD	7202	7	124
42	1	MULLIT	320.41.6	SILLA PATA MADERA CHAIR WITH WOODEN FEET	049-GRIS SEDA SILK GREY	7200	7	124
43	1	MULLIT	320.41.7	SILLA PATA METAL CHAIR WITH METAL FEET	151- NEGRO BLACK	7203	7	124
44	1	MULLIT	320.41.6	SILLA PATA MADERA CHAIR WITH WOODEN FEET	006- ANTRACITA ANTHRACITE	6233	6	123
45	1	MULLIT	320.41	SILLA ESTRUCTURA METAL METAL STRUCTURE CHAIR	088-ORO GOLD	6153	6	117
46	1	TORTUGA	305.74.D110	MESA COMEDOR D110X74 TABLE DINING D110X74	056-ROJO RED	-	-	-
47	1	TONELLA	301.46	TABURETE STOOL	104-BRONCE BRONZE	CRYSFIELD973	10	CRYSTAL FIELD KVADRAT
48	1	TONELLA	301.46	TABURETE STOOL	103-NACAR	7201	7	124
49	1	TONELLA	301.46.2	TABURETE BAJO LOW STOOL	103-NACAR	7200	7	124
50	2	TONELLA	301.46	TABURETE STOOL	104-BRONCE BRONZE	ATL63055	2	112
51	2	TONELLA	301.51.G	BUTACA ACOLCHADA QUILTED MINI ARMCHAIR	104-BRONCE BRONZE	STCTR124	7	STEELCUT TRIO 3 KVADRAT
52	1	DUMBELL	318.71.D70X40	MESITA D70X40 OCCASIONAL TABLE D70X40	128 MEGEVE	-	-	-
53	1	DUMBELL	318.79.D70X110	MESA D70X110 TABLE D70X110	128 MEGEVE	-	-	-
54	1	TONELLA	301.46	TABURETE STOOL	103-NACAR	FACET 01	4	107

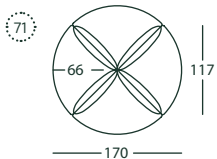
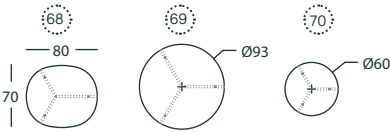
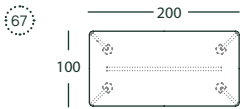
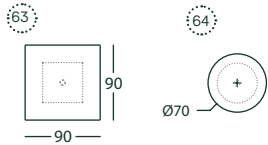
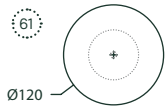
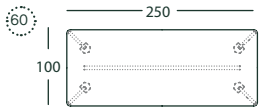
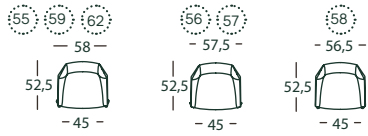

ID	UNI. QTY.	MOD.	REF.	DESCRIPCIÓN / DESCRIPTION	ACABADO FINISHES	TELAS / MATERIAL	SERIES	MUESTRARIO SAMPLE BK.
55	1	NIDO	288.41.6G	SILLA PATA MADERA ACOLCHADA C/VIVO QUILTED DINING CH. WOOD FT. & PIPING	049-GRIS SEDA SILK GREY	7200	7	124
56	2	NIDO	288.41.7G	SILLA PATA METAL ACOLCHADA C/VIVO QUILTED DINING CH. METAL FEET & PIPING	151- NEGRO BLACK	7203	7	124
57	2	NIDO	288.41.7	SILLA PATA METAL C/VIVO DINING CH. METAL FEET & PIPING	151- NEGRO BLACK	GALAX108	7	GALAXY KVADRAT
58	2	NIDO	288.41.61	SILLA PATA MADERA BASIC C/VIVO DINING CH. BASIC WOOD FEET & PIPING	052-KLEIN BLUE	7202	7	124
59	2	NIDO	288.41.6G	SILLA PATA MADERA ACOLCHADA C/VIVO QUILTED DINING CH. WOOD FT. & PIPING	006- ANTRACITA ANTHRACITE	6233	6	123
60	1	TORTUGA	305.74.250	MESA 250X100X74 TABLE 250X100X74	002- NATURAL	-	-	-
61	1	DUMBBELL	318.74.D120X74	MESA COMEDOR D120X74 DINING TABLE D120X74	127-BRIQUE	-	-	-
62	1	NIDO	288.41.6G	SILLA PATA MADERA ACOLCHADA C/VIVO QUILTED DINING CH. WOOD FT. & PIPING	049-GRIS SEDA SILK GREY	7203	7	124
63	1	DUMBBELL	318.74.90X74	MESA COMEDOR 90X90X74 DINING TABLE 90X90X74	126 CENDRE	-	-	-
64	1	DUMBBELL	318.79.D70X110	MESA D70X110 TABLE D70X110	001-NOIR	-	-	-
65	1	DUMBBELL	318.71.D70X50	MESITA D70X50 OCCASIONAL TABLE D70X50	127 BRIQUE	-	-	-
66	1	DUMBBELL	318.71.D70X60	MESITA D70X60 TABLE D70X60	001-NOIR	-	-	-
67	1	TORTUGA	305.74.200	MESA 200X100X74 TABLE 200X100X74	003-NOGAL WALNUT	-	-	-
68	1	LA ISLA	314.71.80X70X35	MESITA 80X70X35 OCCASIONAL TABLE 80X70X35	112- MALAQUITA MALACHITE	-	-	-
69	1	LA ISLA	314.71.D93X40	MESITA D93X40 OCCASIONAL TABLE D93X40	093- CUARZO QUARTZ GREY	-	-	-
70	1	LA ISLA	314.71.D60X45	MESITA D60X45 OCCASIONAL TABLE D60X45	123 ULTRAMAR	-	-	-
71	1	LA ISLA	314.10.TTH	BANCO D170 BENCH D170	112- MALAQUITA MALACHITE	7201	7	124



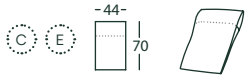
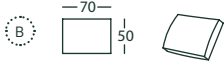
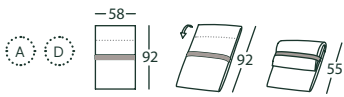

ID	UNI. QTY.	MOD.	REF.	DESCRIPCIÓN / DESCRIPTION	ACABADO FINISHES	TELAS / MATERIAL	SERIES	MUESTRARIO SAMPLE BK.
A	1	MOUSSE	317.29.FK	ALMOHADA PLEGABLE 58X92/55 C/CINTA FOLDABLE CUSHION 58X92/55 W/TAPE	-	6235 / ATLANTIC 63057	6	123
B	1	MOUSSE	317.21.HF	ALMOHADA DECORACION 70X50 C/BANDA CUSHION 70X50 WITH BAND	-	6216	6	121
C	1	MOUSSE	317.25.EH	ALMOHADA CABEZAL 44X70 CUSHION HEADREST 44X70	-	6216	6	121
D	1	MOUSSE	317.29.FK	ALMOHADA PLEGABLE 58X92/55 C/CINTA FOLDABLE CUSHION 58X92/55 W/TAPE	-	6216 / ATLANTIC 62049	6	121
E	1	MOUSSE	317.25.EH	ALMOHADA CABEZAL 44X70 CUSHION HEADREST 44X70	-	6235	6	123
F	1	MANDARINA	267.24.E.O	MANDARINA COJIN D40X14 FRUNCIDO MANDARINA WINKLED CUSHION D40X14	-	ATLANTIC 62049	2	112
G	1	TECNO	283.29.EE	COJIN 40X40 C/BOLSILLO CUSHION 40X40 WITH POUCH	-	OMEGA 60121	5	OMEGA GABRIEL

# COSAS



119  
116  
**326.3M.MM**  
BORN FREE MINI MANTA  
ACOLCHADA 119X116  
BORN FREE TINY QUILTED  
THROW 119X116



131  
204  
**325.3M.PW**  
LINDO GATITO MANTA  
ACOLCHADA 131X204  
LINDO GATITO QUILTED  
THROW 131X204

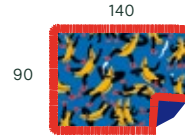

140  
90  
**321.3M.S.BG01**  
TÁPAME MUCHO S BANANA GUYS  
AZUL FLECO ROJO  
TÁPAME MUCHO S BLUE  
BANANA GUYS RED FRINGES

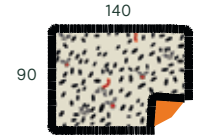

140  
90  
**321.3M.S.WD01**  
TÁPAME MUCHO S WILD DOTS BEIGE  
FLECO NEGRO  
TÁPAME MUCHO S BEIGE WILD  
DOTS BLACK FRINGES

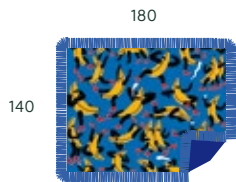

180  
140  
**321.3M.L.BG01**  
TÁPAME MUCHO L BANANA GUYS  
AZUL FLECO AZUL  
TÁPAME MUCHO L BLUE  
BANANA GUYS BLUE FRINGES

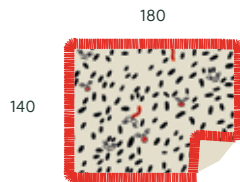

180  
140  
**321.3M.L.WD01**  
TÁPAME MUCHO L WILD DOTS BEIGE  
FLECO ROJO  
TÁPAME MUCHO L BEIGE  
WILD DOTS RED FRINGES

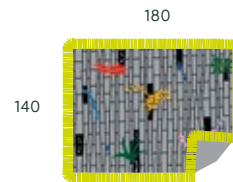

180  
140  
**321.3M.L.UJ01**  
TÁPAME MUCHO L URBAN  
JUNGLE GRIS FLECO AMARILLO  
TÁPAME MUCHO L GREY URBAN  
JUNGLE YELLOW FRINGES



28  
27  
**322.2.S.WD02**  
FLOWER POWER S WILD DOTS 02



28  
27  
**322.2.S.VA01**  
FLOWER POWER S VALIENTE 01

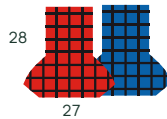

28  
27  
**322.2.S.GR01**  
FLOWER POWER S GRID 01

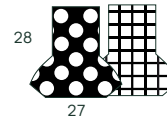

28  
27  
**322.2.S.MO02**  
FLOWER POWER S  
MONOCHROME 02



35  
42  
**322.2.L.BG02**  
FLOWER POWER L BANANA GUYS 02

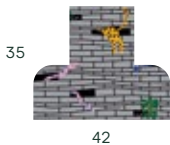

35  
42  
**322.2.L.UJ02**  
FLOWER POWER L URBAN JUNGLE 02

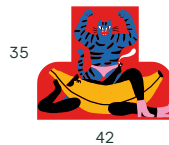

35  
42  
**322.2.L.RE01**  
FLOWER POWER L RELAX 01

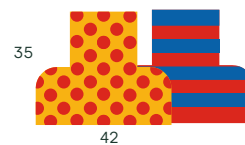

35  
42  
**322.2.L.RU01**  
FLOWER POWER L RUMBA 01

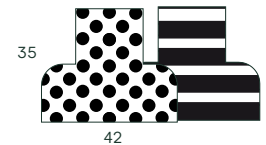

35  
42  
**322.2.L.MO01**  
FLOWER POWER L MONOCHROME 01

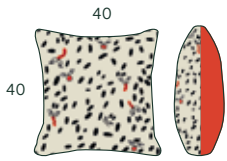

**323.22.EE.WD01**  
**FLORA & FAUNA COJIN 40X40 - WILD**  
**DOTS 01 / PELO NARANJA**  
**FLORA & FAUNA CUSHION**  
**40X40 - WD01 / ORANGE FUR**

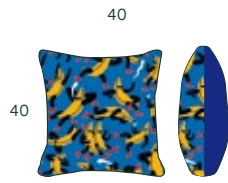

**323.22.EE.BG01**  
**FLORA & FAUNA COJIN 40X40 -**  
**BANANA GUYS 01 / PELO AZUL**  
**FLORA & FAUNA CUSHION**  
**40X40 - BG01 / BLUE FUR**

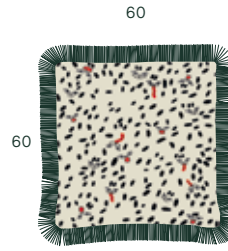

**323.22.GG.WD01**  
**FLORA & FAUNA COJIN 66X66 C/**  
**FLECOS - WILD DOTS 01**  
**FLORA & FAUNA CUSHION**  
**66X66 W/FRINGES - WD01**

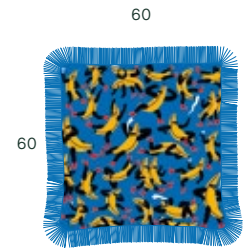

**323.22.GG.BG01**  
**FLORA & FAUNA COJIN 66X66 C/**  
**FLECOS - BANANA GUYS 01**  
**FLORA & FAUNA CUSHION**  
**66X66 W/FRINGES - BG01**

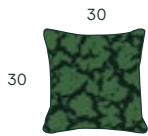

**324.22.DD.C1**  
**RIFT COJIN 30X30 VERDE**  
**RIFT CUSHION 30X30 GREEN**

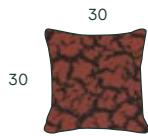

**324.22.DD.C2**  
**RIFT COJIN 30X30 TEJA**  
**RIFT CUSHION 30X30 BRICK-RED**

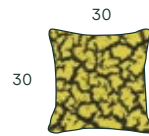

**324.22.DD.C3**  
**RIFT COJIN 30X30 AMARILLO**  
**RIFT CUSHION 30X30 YELLOW**

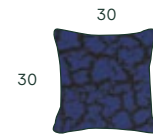

**324.22.DD.C4**  
**RIFT COJIN 30x30 AZUL**  
**RIFT CUSHION 30x30 BLUE**

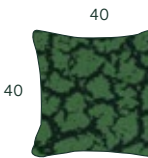

**324.22.EE.C1**  
**RIFT COJIN 40X40 VERDE**  
**RIFT CUSHION 40X40 GREEN**

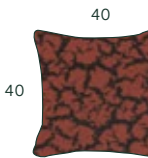

**324.22.EE.C2**  
**RIFT COJIN 40X40 TEJA**  
**RIFT CUSHION 40X40 BRICK-RED**

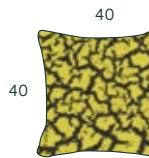

**324.22.EE.C3**  
**RIFT COJIN 40X40 AMARILLO**  
**RIFT CUSHION 40X40 YELLOW**

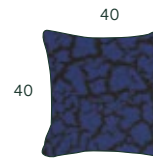

**324.22.EE.C4**  
**RIFT COJIN 40X40 AZUL**  
**RIFT CUSHION 40X40 BLUE**

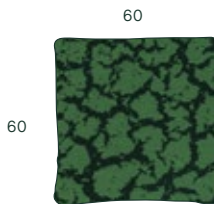

**324.22.GG.C1X**  
**RIFT COJIN 66X66 ULTRA SOFT VERDE**  
**RIFT EXTRA SOFT CUSHION**  
**66X66 GREEN**

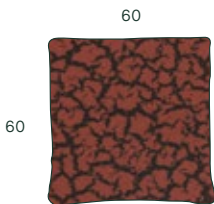

**324.22.GG.C2X**  
**RIFT COJIN 66X66 ULTRA SOFT TEJA**  
**RIFT EXTRA SOFT CUSHION**  
**66X66 BRICK-RED**

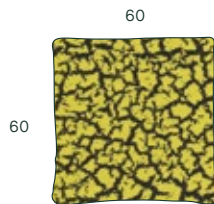

**324.22.GG.C3X**  
**RIFT COJIN 66X66 ULTRA SOFT**  
**AMARILLO**  
**RIFT EXTRA SOFT CUSHION**  
**66X66 YELLOW**

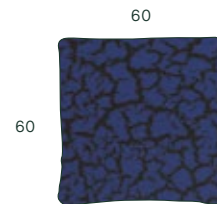

**324.22.GG.C4X**  
**RIFT COJIN 66X66 ULTRA SOFT AZUL**  
**RIFT EXTRA SOFT CUSHION**  
**66X66 BLUE**



## **SANCAL** REF. 18014\_JUNGLA

SANCAL DISEÑO, S.L.  
Pol. Ind. La Herrada C/ Príncipe de Asturias, 18  
30510 Yecla (Murcia) Spain  
Tel Esp. +34 968 75 15 03  
Tel. Eng. +34 968 71 90 62  
Tel. Fra. +34 968 71 90 61  
Fax +34 968 79 40 62  
e-mail web@sancal.com  
www.sancal.com

Art direction & styling Juan Ibáñez & Elena Castaño-López  
Photography Marcelo Martínez  
Coordination Esther Castaño-López  
Graphic project Juan Ibáñez & Sonia Marco

Copyright © Sancal Diseño S.L. 2018



Compromiso con el  
Desarrollo Sostenible  
REGION DE MURCIA



